

AGRICULTURE TIRES TECHNICAL DATABOOK

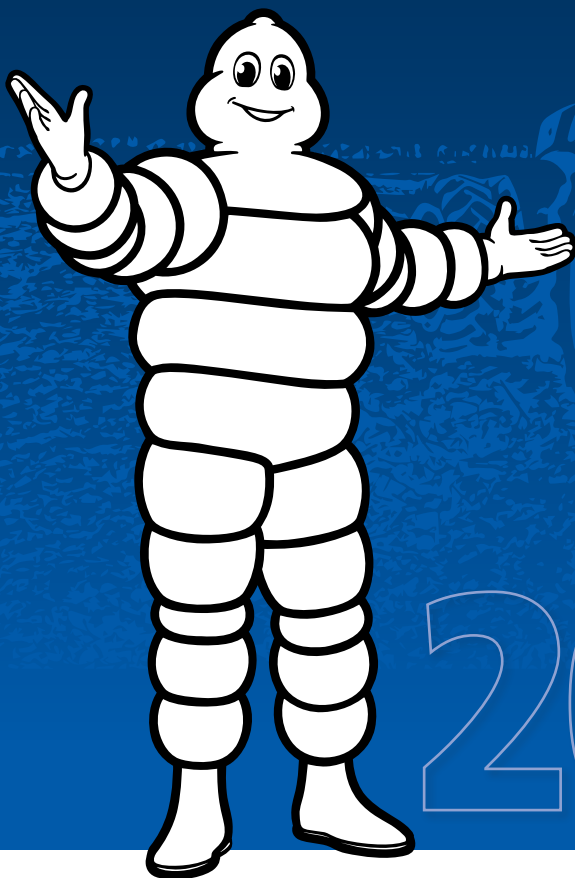

2020

JULY 2020

 [AGRO.MICHELIN.COM](https://agro.michelin.com)

 [@MICHELINAGRIUK](https://twitter.com/MICHELINAGRIUK)

 [MICHELIN AGRICULTURE](https://www.youtube.com/MICHELIN AGRICULTURE)

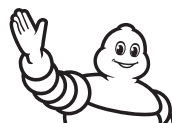

MICHELIN

NOTES

20 horizontal dotted lines for writing notes.

SUMMARY

READING THE TECHNICAL DATA	6
EQUIVALENCE CHART	7
TIRES BY SIZES	9
ROLLING CIRCUMFERENCE CHART	14
LOAD INDEX	22
NEW LOAD/PRESSURE	23
ZEN@TERRA	24
MICHELIN ULTRAFLEX TECHNOLOGIES	25
TRACTORS	26
MICHELIN EVOBIB	26
MICHELIN ROADBIB	28
MICHELIN AXIOBIB 2	32
MICHELIN AXIOBIB	39
MICHELIN MACHXBIB	46
MICHELIN XEOBIB	54
MICHELIN MULTIBIB	58
MICHELIN OMNIBIB	66
MICHELIN YILDBIB	73
MICHELIN AGRIBIB 2	77
MICHELIN AGRIBIB	85
HARVESTERS & FLOATERS	97
MICHELIN CEREXBIB 2	97
MICHELIN CEREXBIB	103
MICHELIN FLOATXBIB	108
MICHELIN MEGAXBIB 2	111
MICHELIN MEGAXBIB	115
ROW CROP	122
MICHELIN SPRAYBIB	122
MICHELIN AGRIBIB ROW CROP	126
TRAILERS & IMPLEMENTS	130
MICHELIN TRAILXBIB	130
MICHELIN CARGOXBIB HIGH FLOTATION	132
MICHELIN CARGOXBIB HEAVY DUTY	137
MICHELIN CARGOXBIB	139
MICHELIN XP 27	142
MICHELIN XS	144

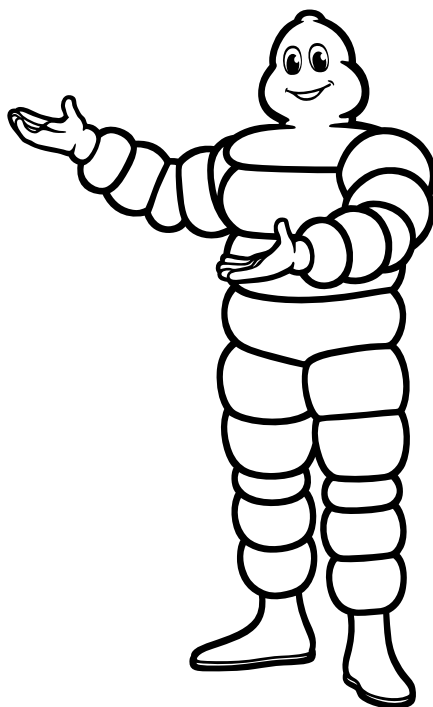

READING THE TECHNICAL DATA

Ø inches

Rim diameter in inches

Local country & International Product Code

(e) Maximum overall section width on measuring rim in millimeters

(D) Overall diameter in millimeters

(R') Static laden radius in millimeters

(RC) Rolling Circumference in millimeters

Ø inches	Description	CAI	e mm	D mm	R' mm	RC mm	Recommended Rim	Acceptable Rim	Tube (Code)	75% internal volume (litres)	Tread depth (mm)
30	VF 540/65 R30 158D/155E TL	296638	536	1460	641	4316	W18L	W16L (NRO)	754	332	48

(TL) Tubeless

Specific markings for very high technology tires

- **IF: Improved Flexion**
(Tires designed to operate at 20% higher rated load than standard metric tires at the same inflation pressure.)
- **VF: Very High Flexion**
(Tires designed to operate at 40% higher rated load than standard metric tires at the same inflation pressure.)
- **CFO & CFO+: Improved Flexion Cyclic Field Operation**
(Cyclic Field Operating parameters for IF and VF designated tires)

Pressure scale in bar and psi

Bar	0.4	0.6	0.8	0.9	1	1.1	1.2	1.3	1.4	1.5	1.6	1.7	1.8	1.9	2
Psi	6	9	12	13	15	16	17	19	20	22	23	25	26	28	29
65 km/h	2180	2500	2690	2875	3065	3250	3405	3565	3720	3875	3970	4065	4155	4250	
70 km/h	2000	2295	2470	2640	2815	2985	3130	3270	3415	3555	3640	3730	3815	3900	
65 km/h Dual	1920	2180	2310	2440	2570	2700	2830	2960	3090	3220	3350	3480	3610	3740	

Maximum speed in km/h

Load per tire in kg



Important notes for tire use appear at the end of technical data pages for each range.

EQUIVALENCE CHART

STAGE 1

Identify the relevant SRI using the original size.

Speed Radius Index (SRI) is a parameter used to calculate the theoretical speed of vehicles for homologation procedures by vehicle manufacturers and for the interchangeability of different tire sizes.

Ø	SIZES	SRI	Ø	SIZES	SRI	Ø	SIZES	SRI	Ø	SIZES	SRI
16	6.50R16	360	26	480/70R26	650	32	210/95R32 (8.3R32)	575	38	580/70R38	875
	7.50R16	390		23.1-26	750		230/95R32 (9.5R32)	600		620/70R38	875
	250/80R16	390		520/80R26	700		270/95R32 (11.2R32)	625		650/65R38	875
	260/70R16	360		540/65R26	650		320/85R32 (12.4R32)	650		650/75R38	925
	280/65R16	360		580/70R26	675		650/75R32 (24.5R32)	825		650/85R38	975
	280/70R16	390		620/70R26	725		680/75R32 (30.5LR32)	875		680/75R38	925
18	320/65R16	390	28	620/75R26	750	34	680/85R32	925	42	710/60R38	875
	7.50R18	410		750/50R26	675		800/65R32	875		710/70R38	925
	280/70R18	410		750/65R26	750		800/70R32	925		710/85R38	1025
	320/65R18	410		9.5R28	550		900/60R32	925		750/65R38	925
	340/65R18	425		250/85R28	550		1000/55R32	875		800/70R38	975
	7.50R20	425		280/85R28 (11.2R28)	575		1050/50R32	875		900/60R38	975
20	9.5R20	450	30	320/70R28	575	36	320/85R34	675	44	230/95R40 (9.5R40)	700
	11.2R20	475		320/85R28 (12.4R28)	600		380/85R34	725		270/95R42 (11.2R42)	750
	12.4R20	500		340/65R28	550		420/85R34 (16.9R34)	750		300/95R42 (12.4R42)	800
	13.6R20	525		340/85R28 (13.6R28)	625		460/85R34 (18.4R34)	775		320/90R42	800
	14.9LR20	525		360/70R28	600		480/70R34	750		480/80R42 (18.4R42)	875
	260/80R20	450		380/70R28	625		520/70R34	775		520/85R42 (20.8R42)	925
	280/70R20	425		380/85R28 (14.9R28)	650		520/75R34	775		580/85R42	975
	280/85R20	475		420/65R28	600		540/65R34	750		620/70R42	925
	300/70R20	450		420/70R28	650		600/60R34	750		650/65R42	925
	320/70R20	475		420/75R28	650		600/65R34	775		650/85R42	1025
	320/85R20	500		420/85R28 (16.9R28)	675		620/75R34	825		710/60R42	925
	24	340/65R20		450	32		440/65R28	625		38	650/60R34
340/75R20		500	480/60R28	625		650/65R34	825	710/75R42	1025		
360/70R20		500	480/65R28	650		650/75R34	875	900/50R42	925		
380/70R20		525	480/70R28	675		710/60R34	825	900/60R42	1025		
380/75R20		525	520/60R28	650		710/75R34	925	210/95R44 (8.3R44)	725		
420/65R20		500	540/65R28	675		210/95R36 (8.3R36)	625	230/95R44 (9.5R44)	750		
440/65R20		525	600/60R28	675		230/95R36 (9.5R36)	650	270/95R44 (11.2R44)	775		
8.3R24		475	600/65R28	700		270/95R36 (11.2R36)	675	270/95R46 (11.2R46)	800		
250/85R24 (9.5R24)		500	600/70R28	725		320/85R36 (12.4R36)	700	300/95R46 (12.4R46)	825		
280/85R24 (11.2R24)		525	380/85R30 (14.9R30)	675		340/85R36 (13.6R36)	725	320/90R46	825		
300/70R24		500	420/70R30	675		270/95R38 (11.2R38)	700	340/85R46 (13.6R46)	825		
320/70R24		525	420/85R30 (16.9R30)	700		320/85R38 (12.4R38)	725	380/90R46	875		
25	320/85R24 (12.4R24)	550	34	420/90R30	725	40	340/85R38 (13.6R38)	750	48	420/80R46	875
	340/85R24 (13.6R24)	575		460/85R30 (18.4R30)	725		380/80R38	750		480/80R46	925
	360/70R24	550		480/70R30	700		380/95R38	800		520/85R46 (20.8R46)	975
	380/70R24	575		480/75R30	700		400/75R38 (15.5R38)	750		620/70R46	925
	380/85R24 (14.9R24)	600		520/70R30	725		420/85R38 (16.9R38)	800		750/75R46	≥ 1075
	400/70R24	575		520/85R30	775		460/85R38 (18.4R38)	825		900/65R46	≥ 1075
	420/65R24	550		540/65R30	700		480/70R38	800		230/95R48 (9.5R48)	800
	420/70R24	600		600/60R30	700		520/70R38	825		270/95R48 (11.2R48)	825
	420/85R24 (16.9R24)	625		600/65R30	725		520/85R38 (20.8R38)	875		340/85R48 (13.6R48)	875
	440/65R24	575		600/70R30	750		540/65R38	800		320/90R50	875
	460/70R24	600		620/70R30	775		600/60R38	800		380/90R50	925
	480/65R24	600		620/75R30	800		600/65R38	825		420/95R50	975
480/70R24	625	650/70R30	800	650/60R38	825	480/80R50	975				
500/70R24	625	710/55R30	725	710/60R30	750	480/95R50	1025				
540/65R24	625	710/60R30	750			52	300/95R52 (12.4R52)	925			
1000/50R25	750					54	270/95R54 (11.2R54)	925			
							320/90R54	925			
							380/90R54	975			

EQUIVALENCE CHART

STAGE 2

Based on the SRI obtained, establish the possible tire size equivalents.

IMPORTANT :

- In no case does the SRI correspond to a specific tread circumference value. Its use in these tables is purely indicative. Verification measurements must be taken.
- Any changes mean you must calculate the axle ratios, evaluate weight distributions and check that the rim widths and diameters are compatible (see technical pages)

SRI	EQUIVALENTS	SRI	EQUIVALENTS	SRI	EQUIVALENTS	SRI	EQUIVALENTS
360	6.50R16	625	210/95R36 // 8.3R36	750	230/95R44 // 9.5R44	875 (1.85m)	320/90R50
	260/70R16		270/95R32 // 11.2R32		270/95R42 // 11.2R42		340/85R48 // 13.6R48
	280/65R16		340/85R28 // 13.6R28		340/85R38 // 13.6R38		380/90R46
7.50R16	380/70R28		380/80R38		420/80R46		
390	250/80R16		420/85R24 // 16.9R24		400/75R38 // 15.5R38		480/80R42 // 18.4R42
	280/70R16		440/65R28		420/85R34 // 16.9R34		520/85R38 // 20.8R38
410	320/65R16		480/60R28		480/70R34		580/70R38
	7.50R18		480/70R24		540/65R34		620/70R38
	280/70R18		500/70R24		600/60R34		650/65R38
425	320/65R18		540/65R24		600/70R30		650/75R34
	7.50R20	230/95R36 // 9.5R36	620/75R26 // 23.1R26	680/75R32 // 30.5LR32			
	280/70R20	320/85R32 // 12.4R32	710/60R30	710/60R38			
450	340/65R18	380/85R28 // 14.9R28	750/65R26	800/65R32			
	9.5R20	420/70R28	1000/50R25	1000/55R32			
	260/80R20	420/75R28	270/95R44 // 11.2R44	1050/50R32			
	300/70R20	480/65R28	460/85R34 // 18.4R34	270/95R54 // 11.2R54			
475	340/65R20	480/70R26	520/85R30	300/95R52 // 12.4R52			
	11.2R20	520/60R28	520/70R34	320/90R54			
	280/85R20	540/65R26	520/75R34	380/90R50			
500	320/70R20	270/95R36 // 11.2R36	600/65R34	480/80R46			
	8.3R24	320/85R34 // 12.4R34	620/70R30	520/85R42 // 20.8R42			
	250/85R24 // 9.5R24	380/85R30 // 14.9R30	650/60R34	620/70R42			
	300/70R24	420/70R30	230/95R48 // 9.5R48	650/65R42			
	320/85R20 // 12.4R24	420/85R28 // 16.9R28	270/95R46 // 11.2R46	650/75R38			
525	340/75R20	480/70R28	300/95R42 // 12.4R42	680/75R38			
	420/65R20	540/65R28	320/90R42	680/85R32			
	280/85R24 // 11.2R24	580/70R26	380/95R38	710/60R42			
	320/70R24	600/60R28	420/85R38 // 16.9R38	710/70R38			
	380/70R20	750/50R26	480/70R38	710/75R34			
550	380/75R20 // 13.6R20	230/95R40 // 9.5R40	540/65R38	750/65R38			
	14.9LR20	270/95R38 // 11.2R38	600/60R38	800/70R32			
	440/65R20	320/85R36 // 12.4R36	620/75R30	900/50R42			
	250/85R28 // 9.5R28	420/85R30 // 16.9R30	650/70R30	900/60R32			
	320/85R24 // 12.4R24	480/70R30	650/75R30	380/90R54			
575	340/65R28	480/75R30	270/95R48 // 11.2R48	420/95R50			
	360/70R24	520/80R26	300/95R46 // 12.4R46	480/80R50			
	420/65R24	540/65R30	320/90R46	520/85R46 // 20.8R46			
	210/95R32 // 8.3R32	600/60R30	340/85R46 // 13.6R46	580/85R42			
600	280/85R28 // 11.2R28	600/65R28	460/85R38 // 18.4R38	620/70R46			
	320/70R28	210/95R44 // 8.3R44	520/70R38	650/85R38			
	340/85R24 // 13.6R24	320/85R38 // 12.4R38	600/65R38	710/70R42			
	380/70R24	340/85R36	620/75R34	800/70R38			
	400/70R24	380/85R34	650/75R32 // 24.5R32	900/60R38			
	440/65R24	420/90R30	650/65R34	480/95R50			
625	230/95R32 // 9.5R32	460/85R30 // 18.4R30	650/60R38	650/85R42			
	320/85R28 // 12.4R28	520/70R30	710/60R34	710/75R42			
	360/70R28	600/65R30		710/85R38			
	380/85R24 // 14.9R24	600/70R28		900/60R42			
	420/65R28	620/70R26		750/75R46			
	420/70R24	710/55R30		900/65R46			
	460/70R24						
480/65R24							
675							
700							
725							
750							
775							
800							
825 (1.75m)							
925 (1.95m)							
975 (2.05m)							
1025 (2.15m)							
≥ 1075 (2.30m)							

TIRES BY SIZES

SEAT	SIZES	EVOBIB	ROADBIB	AXIOBIB	AXIOBIB 2	MACHXBIB	XEOBIB	MULTIBIB	OMNIBIB	YELDBIB	AGRIBIB	AGRIBIB 2	AGRIBIB RC	CEREXBIB	CEREXBIB 2	FLOATXBIB	MEGAXBIB	MEGAXBIB 2	SPRAYBIB	TRAILXBIB	CARGOXBIB	CARGOXBIB HF	CARGOXBIB 2	CARGOXBIB HD	X P27	XS	
16	270/65 R16																									S	
16	280/70 R16								S																		
16	320/65 R16							S																			
18	270/65 R18																										S
18	320/65 R18							S																			
18	340/65 R18							S																			S
20	280/70 R20								S																		
20	420/65 R20							S																			
20	440/65 R20							S																			
20.5	24/70 R20.5																										S
22.5	500/60 R22.5																				VF				S		
22.5	560/45 R22.5																				VF				S		
22.5	560/60 R22.5																				VF				S		
22.5	600/50 R22.5																				VF	S		S			
22.5	710/45 R22.5																				VF		S				
24	9.5 R24										S																
24	11.2 R24										S																
24	12.4 R24										S																
24	13.6 R24										S																
24	14.9 R24										S																
24	16.9 R24										S																
24	320/70 R24								S																		
24	360/70 R24								S																		
24	380/70 R24								S																		
24	420/65 R24							S																			
24	420/70 R24								S																		
24	440/65 R24							S																			
24	480/65 R24							S																			
24	480/70 R24								S																		
24	540/65 R24							S																			
25	1000/50 R25															VF	S										
26	28LR26																								S		
26	480/80 R26										S																
26	520/80 R26														VF												
26	620/70 R26														VF												
26	620/75 R26															S											

TIRES BY SIZES

SEAT	SIZES	EVOBIB	ROADBIB	AXIOBIB	AXIOBIB 2	MACHXBIB	XEOBIB	MULTIBIB	OMNIBIB	YELDBIB	AGRIBIB	AGRIBIB 2	AGRIBIB RC	CEREXBIB	CEREXBIB 2	FLAOTXBIB	MEGAXBIB	MEGAXBIB 2	SPRAYBIB	TRAILXBIB	CARGOXBIB	CARGOXBIB HF	CARGOXBIB 2	CARGOXBIB HD	X P27	XS	
26	750/50 R26															VF	S										
26	750/65 R26														VF	S											
26.5	600/55 R26.5																				VF	VF					
26.5	650/55 R26.5																				VF	VF					
26.5	710/50 R26.5																				VF	VF					
26.5	800/45 R26.5																					S					
28	12.4 R28										S																
28	13.6 R28										S																
28	14.9 R28										S																
28	16.9 R28										S																
28	280/85 R28											S															
28	380/70 R28								S																		
28	420/65 R28							S																			
28	420/70 R28							S																			
28	420/85 R28											S															
28	440/65 R28							S																			
28	480/60 R28						VF																				
28	480/65 R28							S																			
28	480/70 R28							S																			
28	520/60 R28						VF																				
28	540/65 R28							S																			
28	600/60 R28						VF																				
28	600/65 R28					S																					
28	600/70 R28					S																					
30	16.9 R30										S																
30	18.4 R30										S																
30	380/85 R30											S															
30	420/85 R30											S															
30	420/90 R30											S															
30	480/70 R30							S																			
30	520/85 R30														VF												
30	540/65 R30		S		VF			S																			
30	600/60 R30				VF		VF																				
30	600/70 R30	VF	S	IF	VF	S																					
30	620/70 R30														VF												
30	620/75 R30			IF	VF												S										

TIRES BY SIZES

SEAT	SIZES	EVOBIB	ROADBIB	AXIOBIB	AXIOBIB 2	MACHXBIB	XEOBIB	MULTIBIB	OMNIBIB	YELDBIB	AGRIBIB	AGRIBIB 2	AGRIBIB RC	CEREXBIB	CEREXBIB 2	FLOATXBIB	MEGAXBIB	MEGAXBIB 2	SPRAYBIB	TRAILXBIB	CARGOXBIB	CARGOXBIB HF	CARGOXBIB 2	CARGOXBIB HD	XP27	XS
30	650/75 R30			IF																						
30	710/55 R30					S																				
30	710/65 R30														VF											
30.5	600/60 R30.5																					S				
30.5	650/65 R30.5																				VF	S				
30.5	710/50 R30.5																					S				
30.5	750/60 R30.5																				VF	VF				
30.5	800/45 R30.5																					S				
30.5	850/50 R30.5																					S				
32	650/75 R32											S					S	S								
32	680/85 R32													IF												
32	800/60 R32																						S			
32	800/65 R32														IF			S								
32	800/70 R32														IF		S	S								
32	900/60 R32														VF		S	S								
32	1000/55 R32													IF		IF/VF										
32	1050/50 R32																S	S								
34	18.4 R34									S																
34	320/85 R34											S														
34	380/85 R34								VF		S															
34	420/85 R34								VF																	
34	420/85 R34										S															
34	480/70 R34			IF				S																		
34	500/85 R34														VF											
34	520/70 R34							S																		
34	540/65 R34							S																		
34	600/60 R34						VF																			
34	600/65 R34							S																		
34	620/75 R34																S									
34	650/60 R34		S	IF	VF	S																				
34	650/65 R34		S	IF	VF	S																				
34	710/60 R34			IF	VF																					
34	710/75 R34																S	S								
36	12.4 R36										S															
38	12.4 R38										S															
38	13.6 R38										S															

TIRES BY SIZES

SEAT	SIZES	EVOBIB	ROADBIB	AXIOBIB	AXIOBIB 2	MACHXBIB	XEOBIB	MULTIBIB	OMNIBIB	YELDBIB	AGRIBIB	AGRIBIB 2	AGRIBIB RC	CEREXBIB	CEREXBIB 2	FLOATXBIB	MEGAXBIB	MEGAXBIB 2	SPRAYBIB	TRAILXBIB	CARGOXBIB	CARGOXBIB HF	CARGOXBIB 2	CARGOXBIB HD	XP27	XS
38	18.4 R38										S															
38	20.8 R38										S															
38	320/85 R38												S/IF													
38	380/80 R38									VF	S									VF						
38	380/95 R38									VF	S															
38	420/85 R38											S														
38	480/70 R38								S																	
38	520/70 R38								S																	
38	520/85 R38											S														
38	540/65 R38							S																		
38	580/70 R38								S																	
38	600/60 R38						VF																			
38	600/65 R38							S																		
38	620/70 R38																S	S								
38	650/60 R38				VF		VF																			
38	650/65 R38			IF				S																		
38	650/75 R38					S																				
38	650/85 R38			IF	VF	S											S									
38	680/75 R38													IF												
38	680/80 R38														IF											
38	710/60 R38			IF			VF																			
38	710/70 R38					S																				
38	710/85 R38			IF																						
38	800/70 R38			IF	VF	S										IF										
38	900/60 R38														VF	VF										
42	320/90 R42												S/IF								VF					
42	480/80 R42										S										VF					
42	520/85 R42											S			VF		S									
42	580/85 R42														VF											
42	620/70 R42								S								S									
42	650/60 R42						VF																			
42	650/65 R42		S		VF			S																		
42	650/85 R42				VF																					
42	710/60 R42				VF		VF																			
42	710/70 R42	VF	S	IF	VF	S									VF											
42	710/75 R42		S	IF	VF	S																				

TIRES BY SIZES

SEAT	SIZES	EVOBIB	ROADBIB	AXIOBIB	AXIOBIB 2	MACHXBIB	XEOBIB	MULTIBIB	OMNIBIB	YELDBIB	AGRIBIB	AGRIBIB 2	AGRIBIB RC	CEREXBIB	CEREXBIB 2	FLOATXBIB	MEGAXBIB	MEGAXBIB 2	SPRAYBIB	TRAILXBIB	CARGOXBIB	CARGOXBIB HF	CARGOXBIB 2	CARGOXBIB HD	XP27	XS
42	800/70 R42														IF											
42	900/50 R42					S																				
42	900/60 R42			IF	VF										VF											
44	750/70 R44				VF																					
46	320/90 R46																			VF						
46	340/85 R46												S/IF													
46	380/90 R46												S/IF							VF						
46	420/80 R46											S														
46	480/80 R46								VF											VF						
46	480/80 R46											S														
46	520/85 R46											S														
46	620/70 R46					S																				
46	750/75 R46			IF																						
46	900/65 R46			IF																						
50	320/90 R50												S/IF							VF						
50	380/90 R50												S/IF								VF					
50	420/95 R50																				VF					
50	480/80 R50								VF		S										VF					
50	480/95 R50								VF	S																
54	320/90 R54												S/IF								VF					
54	380/90 R54											S									VF					

Information

- IF = Improved Flexion
- VF = Very High Flexion
- S = Standard

ROLLING CIRCUMFERENCE CHART

TIRE SIZE AND RANGE	CAI	MSPN	Minimum Dual Spacing		Tire Diameter		Rolling Circumference		RCI	SRI
			mm	inches	mm	inches	mm	inches		
			270/65R16 IMP 134A8/122A8 TL X P27	184332	04629	381	15	755		
280/70R16 112D TL OMNIBIB	747196		389	15	805	32	2400	94	390	
320/65R16 107D TL MULTIBIB	494658	39517	434	17	827	33	2452	97	390	
270/65R18 IMP 136A8/124A8 TL X P27	133069	98595	381	15	810	32	2472	97	390	
11LR16 122A8 TL X M27	123207	13902	386	15	850	33	2515	99	0	
320/65R18 109A8/106B TL MULTIBIB	123898	78520	434	17	875	34	2594	102	410	
280/70R20 116D TL OMNIBIB	263806		389	15	904	36	2690	106	32	450
340/65R18 113A8/110B TL MULTIBIB	123888	79647	462	18	911	36	2719	107	32	425
340/65R18 149A8/137A8 TL X P27	415969	08185	462	18	891	35	2720	107	32	425
9.5R24 112A8/109B TL AGRIBIB	200987		340	13	1045	41	3117	123	35	500
420/65R20 125A8/125B TL MULTIBIB	122702	86582	552	22	1064	42	3135	123	35	500
560/45R22.5 152D TL CARGOXBIB HEAVY DUTY	743789	27334	702	28	1080	43	3191	126		525
405/70R20 136G TL X M47	123708	43043	539	21	1076	42	3194	126		0
440/65R20 128D TL MULTIBIB	675464	15810	580	23	1090	43	3260	128		525
11.2R24 119A8/116B TL AGRIBIB	317247	92311	392	15	1095	43	3269	129	36	525
320/70R24 116D TL OMNIBIB	415039	25416	434	17	1101	43	3274	129		525
445/70R19.5 173A8/180A2 TL XF	489102	81617	585	23	1110	44	3331	131		0
425/75R20 148G TL X M47	123706	75328	556	22	1147	45	3398	134		0
420/65R24 126D TL MULTIBIB	171560		552	22	1156	46	3416	134		550
360/70R24 122D TL OMNIBIB	198698	45416	479	19	1153	45	3418	135	37	550
12.4R24 119A8/116B TL AGRIBIB	123788	78449	429	17	1149	45	3420	135	37	550
420/65R24 126A8/126B TL MULTIBIB	122712	77842	552	22	1160	46	3425	135		550
500/60R22.5 155D TL CARGOXBIB HEAVY DUTY	441880	36343	654	26	1172	46	3454	136		550
600/50R22.5 159D TL CARGOXBIB	048429	94336	760	30	1181	46	3478	137		550
440/65R24 128D TL MULTIBIB	426389	04039	580	23	1187	47	3519	139		575
380/70R24 125D TL OMNIBIB	085816	64778	507	20	1188	47	3520	139	38	575
710/45R22.5 165D TL CARGOXBIB HIGH FLOTATION	723051	06153	910	36	1208	48	3545	140		575
280/85R28 123A8/120D TL AGRIBIB 2	392931	40217	389	15	1192	47	3563	140		575
445/70R22.5 175A8/182A2 TL XF	073522	33819	585	23	1192	47	3582	141		0
13.6R24 124A8/121B TL AGRIBIB	262831	06247	465	18	1200	47	3583	141	38	575
VF 560/60R22.5 IMP 166D TL TRAILXBIB	103824	41626	728	29	1242	49	3612	142		600
525/65R20.5 173F TL XS	109421	71848	687	27	1200	47	3640	143		575
560/60R22.5 161D TL CARGOXBIB HEAVY DUTY	102433	20379	728	29	1242	49	3650	144		600
480/65R24 133D TL MULTIBIB	531721	03176	626	25	1240	49	3667	144	38	600
420/65R28 135D TL MULTIBIB	778211	62700	552	22	1238	49	3680	145		600
445/70R24 151G TL X M47	123642	45627	585	23	1239	49	3689	145		0
420/70R24 130D TL OMNIBIB	829095	28067	552	22	1251	49	3702	146	39	600

ROLLING CIRCUMFERENCE CHART

TIRE SIZE AND RANGE	CAI	MSPN	Minimum Dual Spacing		Tire Diameter		Rolling Circumference		RCI	SRI
			mm	inches	mm	inches	mm	inches		
			14.9R24 130A8/127B TL AGRIBIB	601563	92158	504	20	1265		
12.4R28 126A8/123B TL AGRIBIB	738964	20895	429	17	1265	50	3778	149	600	
VF 480/60R28 134D TL XEOBIB	312875	80140	639	25	1298	51	3831	151	39	625
440/65R28 131D TL MULTIBIB	386212	96372	580	23	1291	51	3833	151	39	625
380/70R28 127D TL OMNIBIB	118587	24723	507	20	1294	51	3842	151	39	625
540/65R24 140D TL MULTIBIB	097057	08801	711	28	1312	52	3873	152		625
495/70R24 155G TL X M47	123620	88892	650	26	1311	52	3883	153		0
13.6R28 123A8/120B TL AGRIBIB	123782	87976	465	18	1308	51	3893	153	39	625
480/70R24 138D TL OMNIBIB	375821	02475	626	25	1327	52	3916	154		625
VF 600/55R26.5 IMP 170D TL CARGOXBIB HIGH FLOTATION	377726		760	30	1341	53	3923	154		625
16.9R24 134A8/131B TL AGRIBIB	123854	97341	566	22	1330	52	3935	155		625
VF 520/60R28 138D TL XEOBIB	510495	80236	670	26	1338	53	3942	155	40	650
600/55R26.5 165D TL CARGOXBIB HIGH FLOTATION	550621	32505	760	30	1341	53	3954	156		625
480/65R28 136D TL MULTIBIB	897574	14369	626	25	1339	53	3970	156		650
420/70R28 133D TL OMNIBIB	532215	25705	552	22	1354	53	4012	158	40	650
VF 710/50R26.5 IMP 176D TL CARGOXBIB HIGH FLOTATION	343405		910	36	1380	54	4022	158		650
710/50R26.5 170D TL CARGOXBIB HIGH FLOTATION	892516	29880	910	36	1380	54	4061	160		650
14.9R28 134A8/131B TL AGRIBIB	112235	25543	504	20	1365	54	4072	160	40	650
VF 650/55R26.5 IMP 174D TL TRAILXBIB	054878	37535	825	32	1402	55	4082	161		725
VF 650/55R26.5 IMP 174D TL CARGOXBIB HIGH FLOTATION	776393		825	32	1402	55	4084	161		725
800/45R26.5 174D TL CARGOXBIB	248959	81371	1008	40	1395	55	4097	161		675
24R20.5 176F TL XS	109174	44650	778	31	1374	54	4148	163		650
VF 750/50R26 CFO 174D/170E TL FLOATXBIB	982905	10112			1405	55	4155	164		675
650/55R26.5 169D TL CARGOXBIB HIGH FLOTATION	693431	15666	825	32	1402	55	4158	164		725
750/50R26 160A8/154D TL MEGAXBIB	478428	67149	956	38	1404	55	4162	164	41	675
750/50R26 160A8/154D TL MEGAXBIB 2	236906	81321	956	38	1406	55	4171	164		675
380/85R30 135A8/135B TL AGRIBIB	836509	18784	507	20	1416	56	4194	165	41	675
VF 600/60R28 146D TL XEOBIB	665184	80297	767	30	1429	56	4198	165	41	675
480/70R28 140D TL OMNIBIB	570026	27084	626	25	1427	56	4217	166	41	675
380/85R30 140A8/140B TL AGRIBIB 2	151572	72163	507	20	1416	56	4219	166	41	675
540/65R28 142D TL MULTIBIB	792274	36062	711	28	1427	56	4223	166	41	675
320/85R34 133A8/130B TL AGRIBIB	122760	73532	434	17	1420	56	4239	167	41	675
320/85R34 133A8/133B TL AGRIBIB 2	908266		434	17	1421	56	4243	167	41	675
16.9R28 141A8/138B TL AGRIBIB	984997	13991	566	22	1435	56	4278	168		675
VF 540/65R30 158D/155E TL AXIOBIB 2	296638	06869	710	28	1460	57	4316	170		700
VF 600/60R30 162D/159E TL AXIOBIB 2	371968	06116	767	30	1468	58	4336	171		700
540/65R30 143D TL MULTIBIB	223153	28553	711	28	1472	58	4353	171		700

ROLLING CIRCUMFERENCE CHART

TIRE SIZE AND RANGE	CAI	MSPN	Minimum Dual Spacing		Tire Diameter		Rolling Circumference		RCI	SRI
			mm	inches	mm	inches	mm	inches		
			12.4R36 124A8 TL AGRIBIB	123952	03338	429	17	1460		
VF 600/60R30 147D TL XEOBIB	065253	03690	767	30	1493	59	4379	172	42	700
540/65R30 150D/146E TL ROADBIB	274757	92680	711	28	1464	58	4382	173		700
480/70R30 141D TL OMNIBIB	599351	27236	626	25	1482	58	4388	173	42	700
16.9R30 137A8/134B TL AGRIBIB	123870	41545	566	22	1480	58	4395	173	42	700
VF 520/80R26 CFO 168A8 TL CEREXBIB	972024	61911	670	26	1491	59	4397	173		700
VF 520/80R26 CFO+ 168A8 TL CEREXBIB 2	850494	24394	670	26	1491	59	4400	173		700
710/50R30.5 173D TL CARGOXBIB	002786	92209	910	36	1495	59	4408	174		700
800/45R30.5 176D TL CARGOXBIB	932951	53255	1008	40	1495	59	4408	174		725
600/65R28 154A8/154B TL MACHXBIB	135288	86350	760	30	1485	58	4415	174	42	700
600/60R30.5 169D TL CARGOXBIB	236518	51915	767	30	1496	59	4417	174		700
VF 620/70R26 CFO 173A8 TL CEREXBIB	656967	64298	790	31	1513	60	4458	176	42	725
380/85R34 137A8/137B TL AGRIBIB	122781	59412	507	20	1503	59	4461	176	42	725
VF 620/70R26 CFO+ 173A8 TL CEREXBIB 2	228272	98039	790	31	1513	60	4461	176	42	725
600/65R28 154D/150E TL MACHXBIB	429970	44562	760	30	1494	59	4465	176	42	700
VF 380/85R34 149A8/149B TL YELDBIB	305457	91239	510	20	1510	59	4471	176	43	725
12.4R38 131A8/128B TL AGRIBIB	258138	15336	429	17	1500	59	4484	177	42	725
710/55R30 153D TL MACHXBIB	992342	03784	910	36	1518	60	4489	177		725
420/90R30 147A8/147B TL AGRIBIB 2	508522	71308	552	22	1518	60	4513	178	42	725
320/85R38 143A8/143B TL AGRIBIB RC	758001	50528	434	17	1508	59	4514	178	42	725
380/85R34 142A8/142B TL AGRIBIB 2	009860	84143	507	20	1516.4	60	4519	178	42	725
420/90R30 147A8/147B TL AGRIBIB	953332	68713	552	22	1533	60	4556	179	42	725
18.4R30 142A8/139B TL AGRIBIB	123844	42060	611	24	1550	61	4602	181		725
VF 600/70R30 165D TL EVOBIB	266793	84559	774	30	1574	62	4616	182		750
600/70R30 158D/155E TL ROADBIB	217911	15131	774	30	1569	62	4630	182		750
600/70R28 157D/154E TL MACHXBIB	211033	29237	760	30	1571	62	4652	183		725
540/65R34 145D TL MULTIBIB	712064	22243	711	28	1574	62	4655	183	43	750
VF 600/70R30 168D/165E TL AXIOBIB 2	426719	32376	774	30	1579	62	4659	183	43	750
VF 420/85R34 154A8/154B TL YELDBIB	012445	58965	554	22	1582	62	4682	184	43	750
IF 600/70R30 159D TL AXIOBIB	280086	96393	774	30	1585	62	4683	184	43	750
28LR26 175D TL CARGOXBIB HIGH FLOTATION	224829		907	36	1581	62	4685	184		0
600/70R28 157A8/157B TL MACHXBIB	395016	46139	760	30	1586	62	4694	185		725
VF 600/60R34 149D TL XEOBIB	664777	78329	767	30	1595	63	4699	185	43	750
13.6R38 128A8/125B TL AGRIBIB	123992	66666	465	18	1565	62	4705	185	43	750
VF 380/80R38 167D TL SPRAYBIB	352109	93213	510	20	1577	62	4712	186		750
540/65R34 152D TL MULTIBIB	214036	99445	711	28	1590	63	4716	186	43	750
480/70R34 143D TL OMNIBIB	280033	25021	626	25	1593	63	4728	186	43	750

ROLLING CIRCUMFERENCE CHART

TIRE SIZE AND RANGE	CAI	MSPN	Minimum Dual Spacing		Tire Diameter		Rolling Circumference		RCI	SRI
			mm	inches	mm	inches	mm	inches		
			420/85R34 147A8/147B TL AGRIBIB 2	183733	16801	552	22	1589		
600/70R30 152D TL MACHXBIB	334318	76077	774	30	1605	63	4745	187	43	750
620/75R26 166A8/166B TL MEGAXBIB	614320	89936	801	32	1602	63	4748	187	43	750
420/85R34 147A8/147B TL AGRIBIB	788910	30127	552	22	1595	63	4751	187	43	750
380/80R38 142A8/139D TL AGRIBIB 2	187095	59112	507	20	1595	63	4755	187	43	750
VF 620/70R30 CFO 172A8 TL CEREXBIB	886789	92780	790	31	1615	64	4760	187		775
600/70R30 158D TL MACHXBIB	566557	68124	774	30	1604	63	4760	187	43	750
VF 620/70R30 CFO+ 175A8 TL CEREXBIB 2	049288	53106	790	31	1615	64	4765	188		775
650/65R30.5 176D TL CARGOXBIB HIGH FLOTATION	139310	28171	825	32	1622	64	4776	188		775
850/50R30.5 182D TL CARGOXBIB	938016	69986	1073	42	1628	64	4778	188		775
VF 750/65R26 CFO 177A8 TL CEREXBIB	811382	02320	956	38	1623	64	4780	188		750
VF 750/65R26 CFO+ 180A8 TL CEREXBIB 2	132266	33777	956	38	1623	64	4786	188		750
VF 520/85R30 CFO 172A8 TL CEREXBIB	795916	66188	682	27	1624	64	4794	189	46	775
VF 520/85R30 CFO+ 172A8 TL CEREXBIB 2	188276	86907	682	27	1624	64	4797	189		775
750/65R26 171A8/171B TL MEGAXBIB	983217	36798	956	38	1621	64	4818	190		750
VF 1000/50R25 CFO 190D/186E TL FLOATXBIB	713716	20271	1258	50	1636	64	4845	191		775
VF 380/80R38 149A8/149B TL YELDBIB	870363	35470	510	20	1592	63	4851	191	43	750
VF 750/60R30.5 IMP 187D TL CARGOXBIB HIGH FLOTATION	139588		956	38	1674	66	4875	192		800
520/70R34 148D TL OMNIBIB	939411	29601	676	27	1651	65	4887	192	44	775
VF 320/90R42 163D TL SPRAYBIB	920383	44635	438	17	1634.5	64	4890	193		800
VF 650/60R34 168D/165E TL AXIOBIB 2	202185	39440	831	33	1653	65	4895	193		775
600/65R34 151D TL MULTIBIB	557189	16291	760	30	1654	65	4897	193	44	775
1000/50R25 172A8/166D TL MEGAXBIB 2	852423	76362	1233	49	1654	65	4907	193		750
320/90R42 147A8/147B TL AGRIBIB RC	425361	64720	434	17	1638	64	4908	193	44	800
VF 620/75R30 172D/169E TL AXIOBIB 2	702894	20861	814	32	1670	66	4919	194	44	800
IF 620/75R30 164D TL AXIOBIB	668406	96772	790	31	1670	66	4927	194	44	800
IF 650/60R34 165D TL AXIOBIB	100511	94599	831	33	1661	65	4933	194		775
650/60R34 159D/155E TL ROADBIB	556249	90034	825	32	1651	65	4935	194		775
750/60R30.5 181D TL CARGOXBIB HIGH FLOTATION	101332	77049	956	38	1675	66	4936	194		800
18.4R34 149A8/146B TL AGRIBIB	679786	71754	611	24	1662	65	4940	194	44	775
650/60R34 159D/155E TL MACHXBIB	549996	96892	825	32	1664	66	4950	195		775
VF 710/65R30 CFO+ 179A8 TL CEREXBIB 2	608814	22560	876	34	1676	66	4952	195	44	800
VF 500/85R34 CFO+ 172A8 TL CEREXBIB 2	038009	29877	642	25	1676	66	4961	195		825
540/65R38 147D TL MULTIBIB	114518	28857	711	28	1675	66	4965	195	44	800
420/85R38 144A8/144B TL AGRIBIB	607820	84239	552	22	1676	66	4975	196	44	800
VF 600/60R38 151D TL XEOBIB	349257	80626	767	30	1698	67	5023	198	44	800
IF 710/60R34 164D TL AXIOBIB	712503	67777	900	35	1696	67	5030	198		825

ROLLING CIRCUMFERENCE CHART

TIRE SIZE AND RANGE	CAI	MSPN	Minimum Dual Spacing		Tire Diameter		Rolling Circumference		RCI	SRI
			mm	inches	mm	inches	mm	inches		
			480/70R38 145D TL OMNIBIB	936570	28503	626	25	1694		
380/95R38 147A8/147B TL AGRIBIB	836033	65207	507	20	1689	66	5034	198		800
420/85R38 149A8/149B TL AGRIBIB 2	048439		552	22	1690	67	5035	198	44	800
VF 380/95R38 154A8/154B TL YELDBIB	873023	47225	510	20	1703	67	5044	199	44	800
VF 650/65R34 170D/167E TL AXIOBIB 2	101906	79000	831	33	1710	67	5061	199		825
IF 650/75R30 166D TL AXIOBIB	828322	96826	838	33	1721	68	5071	200	45	825
620/75R30 168A8/168B TL MEGAXBIB	753673	63928	801	32	1710	67	5083	200	44	800
VF 710/60R34 173D/169E TL AXIOBIB 2	757609	99540	900	35	1727	68	5093	201		825
650/65R34 161D/157E TL ROADBIB	330378	35720	825	32	1707	67	5098	201		825
IF 650/65R34 161D TL AXIOBIB	711975	26241	831	33	1721	68	5099	201		825
VF 650/60R38 155D TL XEOBIB	454365	80851	831	33	1735	68	5108	201	45	825
650/65R34 161D/157E TL MACHXBIB	817386	93805	825	32	1726	68	5133	202		825
VF 650/60R38 170D/167E TL AXIOBIB 2	908973		831	33	1742	69	5145	203	45	825
340/85R46 150A8/150B TL AGRIBIB RC	846786	94547	462	18	1747	69	5227	206	45	825
520/70R38 150D TL OMNIBIB	833744	28089	670	26	1766	70	5229	206	45	825
600/65R38 153D TL MULTIBIB	228045	29767	760	30	1768	70	5229	206	45	825
18.4R38 151A8/148B TL AGRIBIB	100097	63603	611	24	1770	70	5267	207	45	825
800/60R32 IMP 185D TL CARGOXBIB HIGH FLOTATION	322432		1032	41	1800	71	5300	209		875
VF 320/90R46 165D TL SPRAYBIB	684579	18963	438	17	1736	68	5350	211		825
VF 710/60R38 160D TL XEOBIB	324138	81759	900	35	1814	71	5356	211	46	875
650/65R38 157D TL MULTIBIB	292904	12871	825	32	1819	72	5380	212	46	875
650/75R32 167A8/167B TL AGRIBIB 2	533727		875	34	1827	72	5395	212	45	875
620/75R34 170A8/170B TL MEGAXBIB	325025	83734	801	32	1814	71	5398	213		825
650/75R32 172A8/172B TL MEGAXBIB 2	642277	38157	875	34	1817	72	5400	213		875
650/75R32 172A8/172B TL MEGAXBIB	468227	46686	875	34	1825	72	5423	214	45	875
580/70R38 155D TL OMNIBIB	001240	31198	743	29	1836	72	5440	214	46	875
VF 650/60R42 157D TL XEOBIB	220583	10918	831	33	1840	72	5441	214		875
IF 650/65R38 169D TL AXIOBIB	508421	87017	831	33	1826	72	5446	214		875
800/65R32 178A8/178B TL MEGAXBIB	521809	49342	1008	40	1840	72	5459	215	46	875
480/80R42 156A8/156B TL AGRIBIB 2	539386	05745	626	25	1840	72	5470	215	46	875
800/65R32 178A8/178B TL MEGAXBIB 2	135425		1008	40	1839	72	5471	215		875
VF 480/80R42 176D TL SPRAYBIB	929553	13814	626	25	1838	72	5471	215	46	875
IF 710/60R38 172D TL AXIOBIB	220975	69189	900	35	1844	73	5486	216		875
520/85R38 160A8/160B TL AGRIBIB 2	882358	05183	670	26	1849	73	5493	216	46	875
IF 800/65R32 CFO 178A8/178B TL CEREXBIB	651074	39571	1006	40	1855	73	5493	216	46	875
IF 800/65R32 CFO+ 181A8 TL CEREXBIB 2	987406	25367	1006	40	1855	73	5501	217		875
20.8R38 159A8/156B TL AGRIBIB	813266	17548	684	27	1850	73	5506	217	46	875

ROLLING CIRCUMFERENCE CHART

TIRE SIZE AND RANGE	CAI	MSPN	Minimum Dual Spacing		Tire Diameter		Rolling Circumference		RCI	SRI
			mm	inches	mm	inches	mm	inches		
			1050/50R32 184A8/184B TL MEGAXBIB	829536	28613	1310	52	1856		
680/75R32 164A8/161B TL MACHXBIB	123582	80305	862	34	1865	73	5512	217	46	875
VF 1000/55R32 CFO 197D/193E TL FLOATXBIB	946690	22389	1258	50	1877	74	5520	217		925
420/80R46 151A8/151B TL AGRIBIB 2	885138		552	22	1854	73	5524	217	46	925
520/85R38 155A8/155B TL AGRIBIB	303668	43308	670	26	1855	73	5529	218	46	875
VF 380/90R46 173D TL SPRAYBIB	198604	27358	510	20	1842	73	5530	218	46	925
VF 320/90R50 166D TL SPRAYBIB	946508	99896	438	17	1844	73	5531	218		925
1050/50R32 178A8/172D TL MEGAXBIB 2	424273	12011	1310	52	1866	73	5537	218		875
480/80R42 156A8/156B TL AGRIBIB	404096	03395	626	25	1858	73	5538	218	46	875
320/90R50 150A8/150B TL AGRIBIB RC	130813	95098	434	17	1847	73	5539	218	46	925
IF 1000/55R32 CFO 191D/188E TL FLOATXBIB	564739		1258	50	1877	74	5540	218		925
620/70R38 170A8/170B TL MEGAXBIB 2	126128		801	32	1857	73	5548	218		875
420/80R46 151A8/148B TL AGRIBIB	122770	58733	552	22	1872	74	5555	219	46	925
620/70R38 170A8/170B TL MEGAXBIB	476088	99512	801	32	1864	73	5557	219	46	875
VF 710/60R42 176D/173E TL AXIOBIB 2	941770	78256	900	35	1885.3	74	5574	219		925
380/90R46 157A8/157B TL AGRIBIB RC	799905	38865	507	20	1864	73	5583	220	46	925
VF 900/60R32 CFO+ 191A8 TL CEREXBIB 2	430737	73624	1120	44	1903	75	5618	221		925
900/60R32 181A8/181B TL MEGAXBIB	824122	40581	1114	44	1894	75	5626	221	46	925
900/60R32 181A8/181B TL MEGAXBIB 2	166896		1114	44	1899	75	5635	222		925
710/75R34 178A8/178B TL MEGAXBIB	543107	13589	910	36	1900	75	5637	222	47	925
IF 900/60R32 CFO 185A8 TL CEREXBIB	752825	03456	1120	44	1906	75	5643	222		925
1050/50R32 178A8 TL MEGAXBIB	236234	94737	1310	52	1902	75	5649	222	46	875
710/75R34 178A8/178B TL MEGAXBIB 2	312036	47924	910	36	1909	75	5671	223	47	925
VF 710/60R42 161D TL XEOBIB	144294	94391	900	35	1920	76	5675	223	47	925
VF 650/65R42 174D/171E TL AXIOBIB 2	387916	43835	831	33	1920	76	5680	224	47	925
650/65R42 165D/161E TL ROADBIB	075643	37067	825	32	1932	76	5693	224		925
IF 680/85R32 CFO 179A8/179B TL CEREXBIB	932041	18128	869	34	1935	76	5711	225	47	925
650/65R42 158D TL MULTIBIB	167733		825	32	1931	76	5722	225	47	925
800/70R32 181A8/181B TL MEGAXBIB	695992	68880	1008	40	1936	76	5725	225		925
VF 480/80R46 164A8/164B TL YELDBIB	842300	10807	626	25	1933	76	5732	226	47	925
800/70R32 181A8/181B TL MEGAXBIB 2	366785		1008	40	1927	76	5737	226		925
IF 1000/55R32 CFO 188A8 TL CEREXBIB	131720	22858	1258	50	1931	76	5758	227		925
650/75R38 169A8/169B TL MACHXBIB	219467	86829	825	32	1948	77	5761	227	47	925
520/85R42 157A8/157B TL AGRIBIB	122791	63687	670	26	1945	77	5771	227	47	925
620/70R42 160D TL OMNIBIB	989457	31015	801	32	1953	77	5781	228	47	925
520/85R42 162A8/162B TL MEGAXBIB	645194	15488	670	26	1937	76	5783	228	47	925
IF 800/70R32 CFO 182A8/182B TL CEREXBIB	525718	18258	1004	40	1958	77	5788	228		925

ROLLING CIRCUMFERENCE CHART

TIRE SIZE AND RANGE	CAI	MSPN	Minimum Dual Spacing		Tire Diameter		Rolling Circumference		RCI	SRI
			mm	inches	mm	inches	mm	inches		
			VF 480/80R46 177D TL SPRAYBIB	159186	21151	626	25	1943		
IF 800/70R32 CFO+ 185A8 TL CEREXBIB 2	789156	71535	1004	40	1950	77	5800	228		925
710/70R38 171D TL MACHXBIB	708197	30751	910	36	1973	78	5804	229	47	925
480/80R46 158A8/158B TL AGRIBIB 2	622709	00639	626	25	1945	77	5804	229	47	925
VF 520/85R42 CFO 177A8 TL CEREXBIB	934265	78620	682	27	1953	77	5807	229	47	925
VF 520/85R42 CFO+ 177A8 TL CEREXBIB 2	270459	15337	682	27	1953	77	5807	229		925
520/85R42 162A8/162B TL AGRIBIB 2	405859	13435	670	26	1958	77	5810	229	47	925
380/90R50 151A8/151B TL AGRIBIB RC	036849	15852	507	20	1935	76	5813	229	47	975
IF 680/75R38 180A8 TL CEREXBIB	833220	02720	830	33	1965	77	5823	229		975
900/50R42 168D TL MACHXBIB	832458	03779	1114	44	1970	78	5826	229	47	975
VF 380/90R50 175D TL SPRAYBIB	722276	28608	510	20	1951	77	5836	230	47	975
IF 380/90R50 167A8/167B TL AGRIBIB RC	212359	88459	510	20	1953	77	5841	230	47	975
VF 320/90R54 168D TL SPRAYBIB	044008	45449	438	17	1950	77	5843	230	47	975
320/90R54 151A8/151B TL AGRIBIB RC	272304	96185	434	17	1950	77	5852	230	47	975
620/70R42 166A8/166B TL MEGAXBIB	100268	15145	801	32	1961	77	5857	231	47	925
480/80R46 158A8/158B TL AGRIBIB	637231	94069	626	25	1948	77	5874	231	47	925
VF 900/60R38 CFO+ 193A8 TL CEREXBIB 2	439024	31193	1144	45	2029	80	5993	236		975
VF 710/70R42 179D TL EVOBIB	363574	21253	910	36	2042	80	6003	236		975
IF 900/60R38 CFO 188A8 TL CEREXBIB	853436	03936	1144	45	2029	80	6017	237	48	975
IF 900/60R38 CFO 184A8 TL CEREXBIB	296920	14429	1144	45	2033	80	6017	237	48	975
710/70R42 173D/170E TL ROADBIB	885975	27650	910	36	2028	80	6025	237		975
IF 680/80R38 CFO+ 182A8 TL CEREXBIB 2	953912	20691	870	34	2020	80	6030	237		975
VF 480/80R50 166A8/166B TL YELDBIB	309830	02098	626	25	2039	80	6034	238	48	975
VF 580/85R42 CFO+ 183A8 TL CEREXBIB 2	844076	45547	754	30	2040	80	6040	238		975
VF 900/60R38 CFO 196D/192E TL FLOATXBIB	098689	02123	1144	45	2033	80	6041	238		975
620/70R46 162D TL MACHXBIB	131721		801	32	2042	80	6055	238		975
IF 800/70R38 CFO 184A8/184B TL CEREXBIB	646846	39234	1004	40	2048	81	6072	239	48	975
IF 650/85R38 179D TL AXIOBIB	084900	97250	821	32	2050	81	6078	239	48	975
IF 800/70R38 CFO 187A8 TL CEREXBIB	445898	24897	1004	40	2051	81	6079	239	48	975
IF 800/70R38 CFO+ 187A8 TL CEREXBIB 2	610997	25474	1004	40	2051	81	6079	239	48	975
520/85R46 158A8/155B TL AGRIBIB	122780	57479	670	26	2050	81	6088	240	48	975
VF 650/85R38 182D/179E TL AXIOBIB 2	655949		845	33	2063	81	6088	240		975
IF 800/70R38 179D TL AXIOBIB	528166	99142	1004	40	2067	81	6089	240	48	975
650/85R38 173A8/173B TL MACHXBIB	118628	89462	825	32	2063	81	6092	240	48	975
800/70R38 173D TL MACHXBIB	887730	29390	1008	40	2066	81	6093	240	48	975
VF 800/70R38 187D/184E TL AXIOBIB 2	136377		1004	40	2072	82	6096	240		975

ROLLING CIRCUMFERENCE CHART

TIRE SIZE AND RANGE	CAI	MSPN	Minimum Dual Spacing		Tire Diameter		Rolling Circumference		RCI	SRI
			mm	inches	mm	inches	mm	inches		
			650/85R38 173A8/173B TL MEGAXBIB	173491	19212	825	32	2048		
VF 480/80R50 179D TL SPRAYBIB	431251	50045	626	25	2045	81	6101	240	48	975
VF 710/70R42 182D/179E TL AXIOBIB 2	523668		910	36	2066	81	6104	240	48	975
520/85R46 164A8/164B TL AGRIBIB 2	120922	17697	670	26	2059	81	6110	241	48	975
IF 710/70R42 179D TL AXIOBIB	771752	99783	910	36	2062	81	6115	241	48	975
480/80R50 159A8/159B TL AGRIBIB 2	263049	41183	626	25	2050	81	6116	241	48	975
VF 420/95R50 177D TL SPRAYBIB	085405	82545	554	22	2052	81	6118	241	48	1025
620/70R46 162A8/162B TL MACHXBIB	122723	69879	801	32	2061	81	6122	241	48	975
380/90R54 152A8/152B TL AGRIBIB 2	075615	28485	507	20	2054	81	6129	241	48	1025
VF 380/90R54 176D TL SPRAYBIB	816598	47923	510	20	2049	81	6131	241	48	1025
480/80R50 159A8/159B TL AGRIBIB	471947	94576	626	25	2056	81	6135	242	48	975
710/70R42 173D TL MACHXBIB	790388	31962	910	36	2088	82	6195	244	48	975
VF 710/70R42 CFO+ 188A8 TL CEREXBIB 2	499992	60118	910	36	2097	83	6207	244		975
IF 710/70R42 CFO 182A8 TL CEREXBIB	003912	61530	910	36	2097	83	6230	245		975
VF 900/60R42 CFO+ 195A8 TL CEREXBIB 2	856296	03717	1108	44	2118	83	6281	247	0	1025
IF 900/60R42 186D TL AXIOBIB	111950	82481	1144	45	2123	84	6304	248	49	1025
VF 900/60R42 189D/185E TL AXIOBIB 2	428922	17679	1108	44	2158	85	6357	250	49	1025
IF 710/85R38 178D TL AXIOBIB	992951	99013	918	36	2159	85	6365	251	49	1025
710/75R42 175D/171E TL ROADBIB	378080	14014	910	36	2143	84	6368	251		1025
VF 710/75R42 184D/180E TL AXIOBIB 2	259635	01608	910	36	2153	85	6370	251	49	1025
IF 800/70R42 CFO+ 189A8 TL CEREXBIB 2	818789	91180	1004	40	2151	85	6387	251	49	1025
VF 650/85R42 183D/180E TL AXIOBIB 2	530764	06000	845	33	2164	85	6393	252	49	1025
IF 710/75R42 176D TL AXIOBIB	037489	25479	910	36	2161	85	6395	252	49	1025
710/75R42 175D/171E TL MACHXBIB	015540	13444	910	36	2158	85	6408	252		1025
VF 750/70R44 186D/183E TL AXIOBIB 2	681569		941	37	2180	86	6438	253		1025
VF 480/95R50 170A8/170B TL YELDBIB	252129	65206	626	25	2186	86	6464	254	49	1075
480/95R50 164A8/164B TL AGRIBIB	491183	54736	626	25	2175	86	6484	255		1075
IF 750/75R46 186D TL AXIOBIB	487001	07217	941	37	2287	90	6819	268	50	1125
IF 900/65R46 190D TL AXIOBIB	162365	36973	1108	44	2322	91	6888	271		1125

LOAD INDEX

LOAD INDEX	KG	LBS	LOAD INDEX	KG	LBS	LOAD INDEX	KG	LBS	LOAD INDEX	KG	LBS
100	800	1 760	151	3 450	7 600	202	15 000	33 100	253	65 000	143 500
101	825	1 820	152	3 550	7 850	203	15 500	34 200	254	67 000	147 500
102	850	1 870	153	3 650	8 050	204	16 000	35 300	255	69 000	152 000
103	875	1 930	154	3 750	8 250	205	16 500	36 400	256	71 000	156 500
104	900	1 980	155	3 875	8 550	206	17 000	37 500	257	73 000	161 000
105	925	2 040	156	4 000	8 800	207	17 500	38 600	258	75 000	165 500
106	950	2 090	157	4 125	9 100	208	18 000	39 700	259	77 500	171 000
107	975	2 150	158	4 250	9 350	209	18 500	40 800	260	80 000	176 500
108	1 000	2 200	159	4 375	9 650	210	19 000	41 900	261	82 500	182 000
109	1 030	2 270	160	4 500	9 900	211	19 500	43 000	262	85 000	187 500
110	1 060	2 340	161	4 625	10 200	212	20 000	44 100	263	87 500	193 000
111	1 090	2 400	162	4 750	10 500	213	20 600	45 400	264	90 000	198 500
112	1 120	2 470	163	4 875	10 700	214	21 200	46 700	265	92 500	204 000
113	1 150	2 540	164	5 000	11 000	215	21 800	48 100	266	95 000	209 500
114	1 180	2 600	165	5 150	11 400	216	22 400	49 400	267	97 500	215 000
115	1 215	2 680	166	5 300	11 700	217	23 000	50 700	268	100 000	220 500
116	1 250	2 760	167	5 450	12 000	218	23 600	52 000	269	103 000	227 000
117	1 285	2 830	168	5 600	12 300	219	24 300	53 600	270	106 000	233 500
118	1 320	2 910	169	5 800	12 800	220	25 000	55 100	271	109 000	240 500
119	1 360	3 000	170	6 000	13 200	221	25 750	56 800	272	112 000	247 000
120	1 400	3 080	171	6 150	13 600	222	26 500	58 400	273	115 000	253 500
121	1 450	3 200	172	6 300	13 900	223	27 250	60 000	274	118 000	260 000
122	1 500	3 300	173	6 500	14 300	224	28 000	61 500	275	121 500	267 000
123	1 550	3 420	174	6 700	14 800	225	29 000	64 000	276	125 000	275 500
124	1 600	3 520	175	6 900	15 200	226	30 000	66 000	277	128 500	283 500
125	1 650	3 640	176	7 100	15 700	227	30 750	68 000	278	132 000	291 000
126	1 700	3 740	177	7 300	16 100	228	31 500	69 500	279	136 000	300 000
127	1 750	3 860	178	7 500	16 500	229	32 500	71 500	280	140 000	308 500
128	1 800	3 960	179	7 750	17 100	230	33 500	74 000	281	145 000	319 500
129	1 850	4 080	180	8 000	17 600	231	34 500	76 000	282	150 000	330 500
130	1 900	4 180	181	8 250	18 200	232	35 500	78 500	283	155 000	341 500
131	1 950	4 300	182	8 500	18 700	233	36 500	80 500	284	160 000	352 500
132	2 000	4 400	183	8 750	19 300	234	37 500	82 500	285	165 000	364 000
133	2 060	4 540	184	9 000	19 800	235	38 750	85 500	286	170 000	375 000
134	2 120	4 680	185	9 250	20 400	236	40 000	88 000	287	175 000	386 000
135	2 180	4 800	186	9 500	20 900	237	41 250	91 000	288	180 000	397 000
136	2 240	4 940	187	9 750	21 500	238	42 500	93 500	289	185 000	408 000
137	2 300	5 080	188	10 000	22 000	239	43 750	96 500	290	190 000	419 000
138	2 360	5 200	189	10 300	22 700	240	45 000	99 000	291	195 000	430 000
139	2 430	5 360	190	10 600	23 400	241	46 250	102 000	292	200 000	441 000
140	2 500	5 520	191	10 900	24 000	242	47 500	104 500	293	206 000	454 000
141	2 575	5 680	192	11 200	24 700	243	48 750	107 500	294	212 000	467 500
142	2 650	5 840	193	11 500	25 400	244	50 000	110 000	295	218 000	480 500
143	2 725	6 000	194	11 800	26 000	245	51 500	113 500	296	224 000	494 000
144	2 800	6 150	195	12 150	26 800	246	53 000	117 000	297	230 000	507 000
145	2 900	6 400	196	12 500	27 600	247	54 500	120 000	298	236 000	520 500
146	3 000	6 600	197	12 850	28 300	248	56 000	123 500	299	243 000	535 500
147	3 075	6 800	198	13 200	29 100	249	58 000	128 000	300	250 000	551 000
148	3 150	6 950	199	13 600	30 000	250	60 000	132 500	301	257 500	567 500
149	3 250	7 150	200	14 000	30 900	251	61 500	135 500	302	265 000	584 000
150	3 350	7 400	201	14 500	32 000	252	63 000	139 000	303	272 500	600 500

NEW LOAD/PRESSURE

NEW LOAD/PRESSURE TABLES AT 10 AND 30 KM/H FOR MICHELIN ULTRAFLEX TECHNOLOGY (MUT) TRACTOR TIRES

MICHELIN has always been an active promoter of standards that enable its customers to benefit from the latest technological revolutions!

The remote inflation breakthrough for the agricultural market required changes to the Improved Flexion (IF) and Very high Flexion (VF) standards, something that was achieved in February 2019 (ETRTO).

The new load/pressure curves at 10 and 30 km/h for MUT tractor tires help to adapt tire pressures to the intended use and context. Combined with a remote inflation system that optimizes these variations in real-time, MICHELIN ULTRAFLEX tires can now offer their very best performance!

- At low pressure in the field, the soil is protected and productivity is optimal.
- At higher pressures on-road, speed is the objective while controlling fuel consumption and ensuring safety and driving comfort.

THE PROOF IN FIGURES

(Example of a calculation based on MACHXBIB (standard), AXIOBIB (IF) and AXIOBIB 2 (VF) – Size 710/70 R42)

PRESSURE DECREASE POSSIBLE WITH A LOAD OF 5500 KG

(bar)	10 km/h	30 km/h	65 km/h
Standard	1	1.3	1.6
IF	-20% 1	-31% 1.1	-38% 1.2
VF	0.8	0.9	1

LOAD INCREASE POSSIBLE WITH A PRESSURE OF 1.2 BAR

(kg)	10 km/h	30 km/h	65 km/h
Standard	6200	5200	4500
IF	+13% 6200	+23% 5700	+40% 5500
VF	7000	6400	6300

ZEN@TERRA®

BEYOND THE TIRE TO PROTECT YOUR SOILS



INCREASED SOIL PROTECTION

- **+4% YIELD***

* 4% increase in yield proven by the Harper Adams University study since 2014 for Ultraflex technology



INCREASED PRODUCTIVITY

- **+30% TRACTION****

** Internal study on MICHELIN EVOBIB vs MICHELIN AXIOBIB tires.



INCREASED PROFITABILITY

- **FUEL CONSUMPTION**
- **IMPROVED ON-ROAD SAFETY AND CONTROL**



SMART PRESSURE CONTROL UNIT



AGROPRESSURE APP. RECOMMENDED PRESSURE

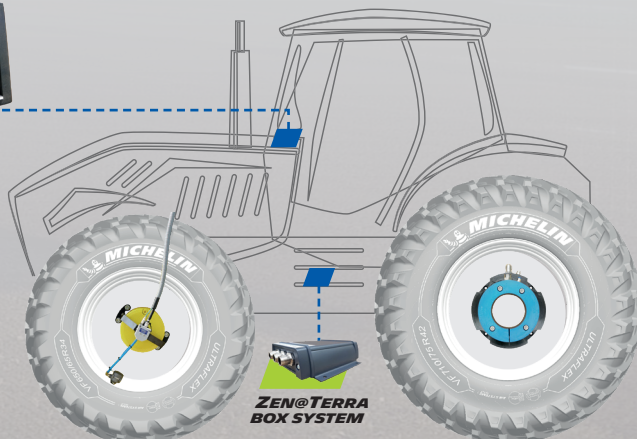

ZEN@TERRA BOX SYSTEM

A MICHELIN TECHNOLOGY TIRE

- Increase your profits even more by using a Michelin ULTRAFLEX tire



A PTG REMOTE INFLATION SYSTEM

- Adapts the tire pressure even while driving



AUTOMATIC PRESSURE CONTROL

- Only 2 clicks on the tractor's Isobus dashboard



MICHELIN SUPPORT

- Setup assistance (via the ZEN@TERRA Agropressure application)
- Help learning to use the system
- Dedicated support hotline

ZEN@TERRA

A MICHELIN solution,
in partnership with



MICHELIN ULTRAFLEX TECHNOLOGIES



GREATER SOIL PROTECTION

MICHELIN Ultraflex technologies produce a larger footprint, which protects the soil from compaction and rutting. Air and water penetrate more freely. Conditions are therefore improved for maximum crop response.

MORE SAVINGS ON FUEL

The larger footprint considerably increases traction, resulting in a clear reduction in tractor wheel slip, enabling to work faster and save on fuel!

GREATER ENDURANCE AND LONGER SERVICE LIFE

Reinforced sidewalls and special rubber compounds make agricultural tires with MICHELIN Ultraflex technologies extremely strong, even at lower pressure.

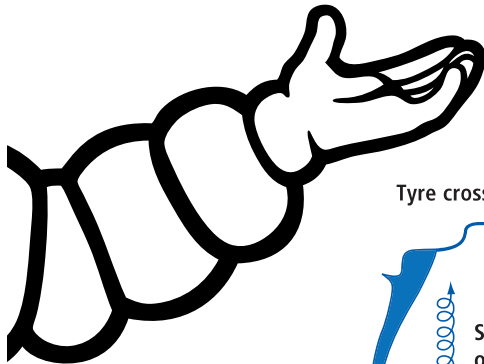

Tyre cross-section:

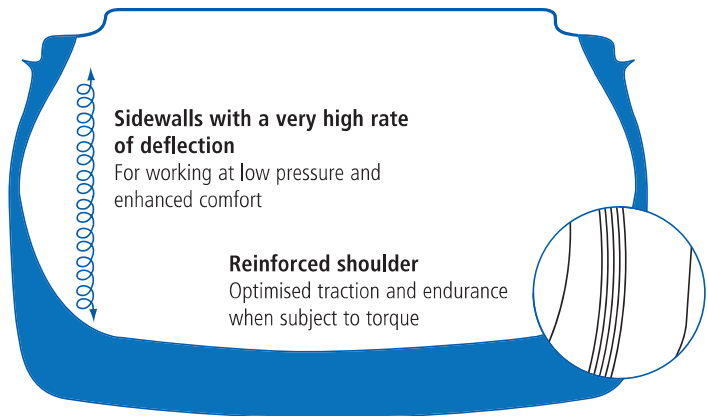

Flat crown

Enlarged footprint to protect soil and deliver maximum traction

LIST OF DISCONTINUED TIRES

This technical DATABOOK is made for information purpose only.

This is not a commercial document.

Please refer to your local Michelin sales representative for tires availability.

CAI	RANGE	DIMENSION
836509	AGRIBIB	380/85R30 135A8/135B TL
953332	AGRIBIB	420/90R30 147A8/147B TL
122760	AGRIBIB	320/85R34 133A8/130B TL
122781	AGRIBIB	380/85R34 137A8/137B TL
788910	AGRIBIB	420/85R34 147A8/147B TL
607820	AGRIBIB	420/85R38 144A8/144B TL
303668	AGRIBIB	520/85R38 155A8/155B TL
404096	AGRIBIB	480/80R42 156A8/156B TL
122791	AGRIBIB	520/85R42 157A8/157B TL
122770	AGRIBIB	420/80R46 151A8/148B TL
637231	AGRIBIB	480/80R46 158A8/158B TL
122780	AGRIBIB	520/85R46 158A8/155B TL
471947	AGRIBIB	480/80R50 159A8/159B TL
550621	CARGOXBIB HIGH FLOTATION	600/55R26.5 165D TL
892516	CARGOXBIB HIGH FLOTATION	710/50R26.5 170D TL
693431	CARGOXBIB HIGH FLOTATION	650/55R26.5 169D TL
101332	CARGOXBIB HIGH FLOTATION	750/60R30.5 181D TL
972024	CEREXBIB	VF 520/80R26 CFO 168A8 TL
656967	CEREXBIB	VF 620/70R26 CFO 173A8 TL
811382	CEREXBIB	VF 750/65R26 CFO 177A8 TL
886789	CEREXBIB	VF 620/70R30 CFO 172A8 TL
795916	CEREXBIB	VF 520/85R30 CFO 172A8 TL
651074	CEREXBIB	IF 800/65R32 CFO 178A8/178B TL
752825	CEREXBIB	IF 900/60R32 CFO 185A8 TL
525718	CEREXBIB	IF 800/70R32 CFO 182A8/182B TL
853436	CEREXBIB	IF 900/60R38 CFO 188A8 TL
296920	CEREXBIB	IF 900/60R38 CFO 184A8 TL
646846	CEREXBIB	IF 800/70R38 CFO 184A8/184B TL
445898	CEREXBIB	IF 800/70R38 CFO 187A8 TL
934265	CEREXBIB	VF 520/85R42 CFO 177A8 TL
003912	CEREXBIB	IF 710/70R42 CFO 182A8 TL
478428	MEGAXBIB	750/50R26 160A8/154D TL
521809	MEGAXBIB	800/65R32 178A8/178B TL
824122	MEGAXBIB	900/60R32 181A8/181B TL
122712	X M108	420/65R24 126A8/126B TL
123582	X M28	680/75R32 164A8/161B TL

TRACTORS

HIGH POWER



MICHELIN EVOBIB

THE 2 IN 1 ADAPTIVE
DESIGN TECHNOLOGY



FOR HIGH-POWERED TRACTOR > 200 HP
Works best with CTIS (Central Tire Inflation System)



«2 IN 1» TIRES TECHNOLOGY
adaptive design on the road or in the fields
VF Very High Flexion



PRODUCTIVITY

- durability
- fuel savings
- 30% more traction⁽¹⁾



SOIL PROTECTION

- 20% larger footprint⁽¹⁾
- Low pressure in the fields



STABILITY at high speed⁽²⁾
Continuous central rib

(1) Internal study – France Ladoux, MICHELIN EVOBIB VF 710/70R42 vs AXIOBIB IF 710/70R42 at 12 psi
(2) Within the limits stipulated in the laws in force in the country

SIZES

VF 600/70R30 165D TL

VF 710/70R42 179D TL

MICHELIN EVOBIB

Tire specifications and pressure table (bar & psi). Load per tire in kg*

Ø inches	Description	CAI	e mm	D mm	R' mm	RC mm	Recommended Rim	Acceptable Rim	Tube (Code)	75% internal volume (litres)	Tread depth (mm)		
30	VF 600/70R30 165D TL	266793	608	1574	668	4616	DW21B (A)	DW20B (A)	737	468	51		
Bar	0.4	0.5	0.6	0.7	0.8	0.9	1	1.1	1.2	1.3	1.4	1.5	1.6
Psi	6	7	9	10	12	13	15	16	17	19	20	22	23
10 km/h			3080	3330	3575	3850	4125	4400	4675	4925	5170	5420	5665
30 km/h			2855	3085	3315	3570	3825	4080	4335	4565	4795	5025	5255
65 km/h			2800	3025	3250	3500	3750	4000	4250	4475	4700	4925	5150
65 km/h Dual	2075	2270	2470	2665	2860	3080	3300	3520	3740	3940	4135	4335	4530

Ø inches	Description	CAI	e mm	D mm	R' mm	RC mm	Recommended Rim	Acceptable Rim	Tube (Code)	75% internal volume (litres)	Tread depth (mm)		
42	VF 710/70R42 179D TL	363574	725	2042	875	6003	DW25B (A)	DW23B (A) MW25B (A)	802	867	54		
Bar	0.4	0.5	0.6	0.7	0.8	0.9	1	1.1	1.2	1.3	1.4	1.5	1.6
Psi	6	7	9	10	12	13	15	16	17	19	20	22	23
10 km/h			4675	5090	5500	5860	6215	6575	6930	7330	7730	8125	8525
30 km/h			4335	4720	5100	5430	5765	6095	6425	6795	7165	7535	7905
65 km/h			4250	4625	5000	5325	5650	5975	6300	6665	7025	7390	7750
65 km/h Dual	3125	3445	3765	4080	4400	4685	4975	5260	5545	5865	6185	6500	6820

***IMPORTANT:**

The inflation pressure must always be appropriate for the load per tire, the speed of travel and the work to be done. Our recommendations above are provided subject to changes made after the date of publication of these tables (July 2020). Technical data is subject to change without prior notice.

- When using single tire configuration:
 - add 0.4 bar for use on slopes of more than 20%
 - add 0.4 bar for intense road use exceeding 50% of time on road
- EVOBIB is a specific tire with an evolutive tread pattern, depending on the inflation pressure:
 - If field pressure is lower or equal 1.5b, then road pressure must be 1.8b
 - If field pressure is upper 1.5b, then road pressure must be 2.0b

TRACTORS

HIGH POWER



MICHELIN ROADBIB

THE SOLUTION FOR HEAVY ROAD USE



FUEL SAVINGS

- A wide footprint combined with an optimized tread depth provides low rolling resistance and thus reduced fuel consumption.



LONG LIFE

- Extraordinary performance in terms of longevity: +20% more rubber to the ground vs. MachXBib
- Exclusive design: new tread pattern
- Directional tires



GREAT COMFORT

- Smooth central rib improves comfort on roads
- Reduced space between patterns (compared to traditional sculptures) limits cabin vibrations
- Quiet running tire - outdoors and indoors



HANDLING & SAFETY

- Improved ride quality thanks to a new sculpture similar to that of a truck tire
- Good tire adhesion on wet roads thanks to vertical evacuation paths

SIZES

540/65R30 150D/146E TL **NEW**

600/70R30 158D/155E TL

650/60R34 159D/155E TL **NEW**

650/65R34 161D/157E TL **NEW**

650/65R42 165D/161E TL **NEW**

710/70R42 173D/170E TL

710/75R42 175D/171E TL **NEW**

MICHELIN ROADBIB

Tire specifications and pressure table (bar & psi). Load per tire in kg*

Ø inches	Description	CAI	e mm	D mm	R' mm	RC mm	Recommended Rim	Acceptable Rim	Tube (Code)	75% internal volume (litres)	Tread depth (mm)
30	540/65R30 150D/146E TL NEW	274757	547	1464	679	4382	DW16L	W18L	754	332	32.5
Bar	0.4 0.6 0.8 1 1.2 1.4 1.6 1.8 2 2.2 2.4 2.6 2.8										
Psi	6 9 12 15 17 20 23 26 29 32 35 38 41										
10 km/h	1930 2185 2445 2700 3000 3300 3600 3900 4200 4405 4615 4820 5025										
30 km/h	1480 1755 2030 2310 2585 2860 3135 3315 3495 3675 3855										
40 km/h	1695 1955 2210 2470 2725 2985 3155 3330 3500 3670										
50 km/h	1630 1875 2120 2370 2615 2860 3025 3190 3355 3520										
65 km/h	1800 2030 2265 2495 2725 2880 3040 3195 3350										
70 km/h	1640 1850 2060 2270 2480 2610 2740 2870 3000										

Ø inches	Description	CAI	e mm	D mm	R' mm	RC mm	Recommended Rim	Acceptable Rim	Tube (Code)	75% internal volume (litres)	Tread depth (mm)
30	600/70R30 158D/155E TL	217911	610	1569	684	4630	DW20B (A)	DW18L DW21B (A)	737	468	40
Bar	0.4 0.6 0.8 1 1.2 1.4 1.6 1.8 2 2.2 2.4 2.6 2.8										
Psi	6 9 12 15 17 20 23 26 29 32 35 38 41										
10 km/h	2475 2830 3185 3540 3955 4375 4790 5210 5625 5815 6000 6190 6375										
30 km/h	1900 2285 2665 3050 3435 3815 4200 4375 4545 4720 4890										
40 km/h	2190 2550 2910 3275 3635 3995 4160 4325 4490 4655										
50 km/h	2100 2445 2795 3140 3490 3835 3995 4150 4310 4465										
65 km/h	2360 2685 3005 3325 3650 3800 3950 4100 4250										
70 km/h	2150 2445 2735 3030 3320 3460 3600 3735 3875										

Ø inches	Description	CAI	e mm	D mm	R' mm	RC mm	Recommended Rim	Acceptable Rim	Tube (Code)	75% internal volume (litres)	Tread depth (mm)
34	650/60R34 159D/155E TL NEW	556249	667	1651	762	4935	DW20B (A)	DW21B (A) DW23B (A)	823	500	38.5
Bar	0.4 0.6 0.8 1 1.2 1.4 1.6 1.8 2 2.2 2.4 2.6 2.8										
Psi	6 9 12 15 17 20 23 26 29 32 35 38 41										
10 km/h	2475 2800 3125 3450 3885 4320 4755 5190 5625 5860 6095 6330 6565										
30 km/h	1900 2285 2665 3050 3435 3815 4200 4410 4615 4825 5030										
40 km/h	2190 2550 2910 3275 3635 3995 4195 4395 4590 4790										
50 km/h	2100 2445 2795 3140 3490 3835 4025 4215 4405 4595										
65 km/h	2300 2640 2975 3310 3650 3830 4015 4195 4375										
70 km/h	2095 2400 2710 3015 3320 3460 3600 3735 3875										

* Refer to the notes at the end of the tables of this range

MICHELIN ROADBIB

Tire specifications and pressure table (bar & psi). Load per tire in kg*

Ø inches	Description	CAI	e mm	D mm	R' mm	RC mm	Recommended Rim	Acceptable Rim	Tube (Code)	75% internal volume (litres)	Tread depth (mm)
34	650/65R34 161D/157E TL NEW	330378	674	1707	785	5098	DW20B (A)	DW21B (A) DW23B (A)	823	555	39.5
Bar	0.4 0.6 0.8 1 1.2 1.4 1.6 1.8 2 2.2 2.4 2.6 2.8										
Psi	6 9 12 15 17 20 23 26 29 32 35 38 41										
10 km/h	2700 3090 3475 3865 4290 4720 5145 5575 6000 6235 6470 6705 6940										
30 km/h	2070 2470 2865 3265 3660 4055 4455 4670 4890 5105 5320										
40 km/h	2385 2755 3130 3500 3875 4245 4450 4655 4860 5065										
50 km/h	2290 2645 3000 3360 3715 4070 4265 4465 4660 4855										
65 km/h	2575 2900 3225 3550 3875 4065 4250 4440 4625										
70 km/h	2345 2640 2935 3230 3525 3675 3825 3975 4125										

Ø inches	Description	CAI	e mm	D mm	R' mm	RC mm	Recommended Rim	Acceptable Rim	Tube (Code)	75% internal volume (litres)	Tread depth (mm)
42	650/65R42 165D/161E TL NEW	075643	633	1932	843	5693	DW20B (A)	DW23B (A) DW21B(A)	802	643	43.2
Bar	0.4 0.6 0.8 1 1.2 1.4 1.6 1.8 2 2.2 2.4 2.6 2.8										
Psi	6 9 12 15 17 20 23 26 29 32 35 38 41										
10 km/h	3000 3400 3800 4200 4675 5145 5620 6090 6565 6855 7145 7435 7725										
30 km/h	2300 2730 3165 3595 4025 4460 4890 5150 5410 5665 5925										
40 km/h	2660 3060 3460 3855 4255 4655 4900 5150 5395 5640										
50 km/h	2550 2935 3315 3700 4080 4465 4700 4940 5175 5410										
65 km/h	2800 3165 3525 3890 4250 4475 4700 4925 5150										
70 km/h	2550 2880 3210 3540 3870 4060 4250 4435 4625										

Ø inches	Description	CAI	e mm	D mm	R' mm	RC mm	Recommended Rim	Acceptable Rim	Tube (Code)	75% internal volume (litres)	Tread depth (mm)
42	710/70R42 173D/170E TL	885975	710	2028	915	6025	DW23B (A)	DW25B (A)	802	867	37.5
Bar	0.4 0.6 0.8 1 1.2 1.4 1.6 1.8 2 2.2 2.4 2.6 2.8										
Psi	6 9 12 15 17 20 23 26 29 32 35 38 41										
10 km/h	3750 4275 4800 5325 6000 6675 7350 8025 8700 8965 9225 9490 9750										
30 km/h	2875 3470 4065 4660 5250 5845 6440 6700 6960 7215 7475										
40 km/h	3285 3855 4425 4990 5560 6130 6380 6625 6875 7120										
50 km/h	3150 3695 4240 4790 5335 5880 6115 6355 6590 6825										
65 km/h	3550 4065 4575 5090 5600 5825 6050 6275 6500										
70 km/h	3230 3695 4165 4630 5095 5320 5550 5775 6000										

* Refer to the notes at the end of the tables of this range

MICHELIN ROADBIB

Tire specifications and pressure table (bar & psi). Load per tire in kg*

Ø inches	Description	CAI	e mm	D mm	R' mm	RC mm	Recommended Rim		Acceptable Rim		Tube (Code)	75% internal volume (litres)	Tread depth (mm)
42	710/75R42 175D/171E TL NEW	378080	742	2143	964	6368	DW23B (A)	DW25B (A) DW21B(A)	802	950	43		
Bar	0.4	0.6	0.8	1	1.2	1.4	1.6	1.8	2	2.2	2.4	2.6	2.8
Psi	6	9	12	15	17	20	23	26	29	32	35	38	41
10 km/h	3975	4525	5075	5625	6300	6975	7650	8325	9000	9340	9675	10015	10350
30 km/h	3050	3690	4335	4975	5615	6260	6900	7160	7420	7675	7935		
40 km/h		3560	4160	4765	5365	5970	6570	6815	7065	7310	7555		
50 km/h		3415	3990	4570	5145	5725	6300	6535	6775	7010	7245		
65 km/h			3750	4315	4875	5440	6000	6225	6450	6675	6900		
70 km/h			3415	3925	4440	4950	5460	5635	5805	5980	6150		

***IMPORTANT:**

The inflation pressure must always be appropriate for the load per tire, the speed of travel and the work to be done. Our recommendations above are provided subject to changes made after the date of publication of these tables (July 2020). Technical data is subject to change without prior notice.

- For plowing and other field applications subject to high torque, use the 30 km/h line.
- When using single tire configuration:
 - add 0.4 bar for use on slopes of more than 20%
 - add 0.4 bar for intensive road use exceeding 50% of time on road
- 10 km/h LT (Low Torque) (max speed 10 km/h).

TRACTORS

HIGH POWER



MICHELIN AXIOBIB 2

HIGH TRACTION CAPACITY FOR HEAVY LOADS



FOR TRACTORS FROM **160 TO 550 HP**



VF Very High Flexion



SOIL PROTECTION thanks to low pressure, up to a 40% reduction in pressure versus a standard radial.



MORE TRACTION ⁽¹⁾



BETTER PRODUCTIVITY from **+7% to +11%** ⁽¹⁾
Potential increase in yields of **up to 4% year** ⁽²⁾

(1) Internal test 2016, depending on the size. Comparing MICHELIN AXIOBIB 2 VF 650/85 R42 vs MICHELIN MACHXBIB 650/85 R38
(2) Harper Adams University 2014/2016

SIZES

VF 540/65R30 158D/155E TL
VF 600/60R30 162D/159E TL
VF 600/70R30 168D/165E TL
VF 620/75R30 172D/169E TL
VF 650/60R34 168D/165E TL
VF 650/65R34 170D/167E TL
VF 710/60R34 173D/169E TL NEW

VF 650/60R38 170D/167E TL
VF 650/85R38 182D/179E TL
VF 800/70R38 187D/184E TL
VF 710/60R42 176D/173E TL
VF 650/65R42 174D/171E TL
VF 710/70R42 182D/179E TL
VF 710/75R42 184D/180E TL

VF 900/60R42 189D/185E TL NEW
VF 650/85R42 183D/180E TL
VF 750/70R44 186D/183E TL

MICHELIN AXIOBIB 2

Tire specifications and pressure table (bar & psi). Load per tire in kg*

Ø inches	Description	CAI	e mm	D mm	R' mm	RC mm	Recommended Rim	Acceptable Rim	Tube (Code)	75% internal volume (litres)	Tread depth (mm)		
30	VF 540/65R30 158D/155E TL	296638	536	1460	641	4316	W18L	W16L	754	332	48		
Bar	0.6 0.8 0.9 1 1.1 1.2 1.3 1.4 1.5 1.6 1.7 1.8 1.9 2												
Psi	9 12 13 15 16 17 19 20 22 23 25 26 28 29												
10 km/h	2400 2750 2940 3130 3320 3510 3695 3885 4075 4265 4370 4470 4575 4675												
30 km/h	2225 2550 2725 2900 3075 3255 3430 3605 3780 3955 4050 4145 4240 4335												
65 km/h	2180 2500 2670 2845 3015 3190 3360 3530 3705 3875 3970 4065 4155 4250												
65 km/h Dual	1920 2180 2310 2440 2570 2700 2830 2960 3090 3220 3350 3480 3610 3740												
70 km/h	2000 2330 2495 2655 2820 2985 3130 3270 3415 3555 3640 3730 3815 3900												

Ø inches	Description	CAI	e mm	D mm	R' mm	RC mm	Recommended Rim	Acceptable Rim	Tube (Code)	75% internal volume (litres)	Tread depth (mm)		
30	VF 600/60R30 162D/159E TL	371968	597	1468	643	4336	DW20B (A)	DW18L	757	381	49		
Bar	0.4 0.6 0.8 0.9 1 1.1 1.2 1.3 1.4 1.5 1.6 1.7 1.8 1.9 2												
Psi	6 9 12 13 15 16 17 19 20 22 23 25 26 28 29												
10 km/h	2530 2965 3180 3395 3605 3820 4035 4250 4460 4675 4815 4950 5090 5225												
30 km/h	2345 2750 2950 3145 3345 3545 3740 3940 4135 4335 4465 4590 4720 4845												
65 km/h	2300 2695 2890 3085 3280 3475 3665 3860 4055 4250 4375 4500 4625 4750												
65 km/h Dual	1715 2055 2390 2550 2715 2875 3035 3210 3390 3565 3740 3850 3960 4070 4180												
70 km/h	2095 2445 2620 2790 2965 3140 3325 3505 3690 3870 3985 4100 4210 4325												

Ø inches	Description	CAI	e mm	D mm	R' mm	RC mm	Recommended Rim	Acceptable Rim	Tube (Code)	75% internal volume (litres)	Tread depth (mm)		
30	VF 600/70R30 168D/165E TL	426719	624	1579	689	4659	DW21B (A)	DW20B (A)	737	468	58		
Bar	0.4 0.6 0.8 0.9 1 1.1 1.2 1.3 1.4 1.5 1.6 1.7 1.8 1.9 2												
Psi	6 9 12 13 15 16 17 19 20 22 23 25 26 28 29												
10 km/h	3080 3575 3835 4100 4360 4620 4880 5145 5405 5665 5790 5915 6035 6160												
30 km/h	2855 3315 3560 3800 4045 4285 4530 4770 5015 5255 5370 5485 5595 5710												
65 km/h	2800 3250 3490 3725 3965 4200 4440 4675 4915 5150 5265 5375 5490 5600												
65 km/h Dual	2075 2470 2860 3080 3300 3520 3740 3940 4135 4335 4530 4630 4730 4830 4930												
70 km/h	2550 2990 3210 3430 3650 3870 4075 4280 4480 4685 4790 4890 4995 5095												

* Refer to the notes at the end of the tables of this range

MICHELIN AXIOBIB 2

Tire specifications and pressure table (bar & psi). Load per tire in kg*

Ø inches	Description	CAI	e mm	D mm	R' mm	RC mm	Recommended Rim	Acceptable Rim	Tube (Code)	75% internal volume (litres)	Tread depth (mm)		
30	VF 620/75R30 172D/169E TL	702894	662	1670	722	4919	DW23B (A)	DW20B (A) DW21B (A)	737	556	58		
Bar	0.6 0.8 0.9 1 1.1 1.2 1.3 1.4 1.5 1.6 1.7 1.8 1.9 2												
Psi	9 12 13 15 16 17 19 20 22 23 25 26 28 29												
10 km/h	3465 4015 4310 4605 4900 5200 5495 5790 6085 6380 6520 6655 6795 6930												
30 km/h	3215 3725 4000 4275 4545 4820 5095 5370 5640 5915 6045 6170 6300 6425												
65 km/h	3150 3650 3920 4190 4455 4725 4995 5265 5530 5800 5925 6050 6175 6300												
65 km/h Dual	2770 3165 3365 3565 3760 3960 4160 4355 4555 4750 4950 5150 5345 5545												
70 km/h	2890 3380 3625 3870 4115 4360 4600 4845 5085 5325 5440 5555 5670 5785												

Ø inches	Description	CAI	e mm	D mm	R' mm	RC mm	Recommended Rim	Acceptable Rim	Tube (Code)	75% internal volume (litres)	Tread depth (mm)		
34	VF 650/60R34 168D/165E TL	202185	677	1653	732	4895	DW23B (A)	DW21B (A) DW24B (A)	823	500	58		
Bar	0.4 0.6 0.8 0.9 1 1.1 1.2 1.3 1.4 1.5 1.6 1.7 1.8 1.9 2												
Psi	6 9 12 13 15 16 17 19 20 22 23 25 26 28 29												
10 km/h	3080 3565 3830 4090 4355 4615 4880 5140 5405 5665 5790 5915 6035 6160												
30 km/h	2855 3305 3550 3795 4035 4280 4525 4770 5010 5255 5370 5485 5595 5710												
65 km/h	2800 3240 3480 3720 3955 4195 4435 4675 4910 5150 5265 5375 5490 5600												
65 km/h Dual	2025 2445 2860 3055 3245 3440 3630 3855 4080 4305 4530 4630 4730 4830 4930												
70 km/h	2580 2985 3190 3395 3595 3800 4035 4275 4510 4745 4845 4950 5050 5150												

Ø inches	Description	CAI	e mm	D mm	R' mm	RC mm	Recommended Rim	Acceptable Rim	Tube (Code)	75% internal volume (litres)	Tread depth (mm)		
34	VF 650/65R34 170D/167E TL	101906	679	1710	756	5061	DW23B (A)	DW21B (A)	823	600	58		
Bar	0.4 0.6 0.8 0.9 1 1.1 1.2 1.3 1.4 1.5 1.6 1.7 1.8 1.9 2												
Psi	6 9 12 13 15 16 17 19 20 22 23 25 26 28 29												
10 km/h	3385 3950 4205 4460 4715 4975 5230 5485 5740 5995 6145 6300 6450 6600												
30 km/h	3135 3660 3900 4135 4375 4610 4850 5085 5325 5560 5700 5840 5980 6120												
65 km/h	3075 3590 3825 4055 4290 4520 4755 4985 5220 5450 5590 5725 5865 6000												
65 km/h Dual	2265 2695 3125 3360 3600 3835 4070 4250 4435 4615 4795 4915 5040 5160 5280												
70 km/h	2830 3305 3545 3785 4020 4260 4450 4640 4830 5020 5145 5275 5400 5525												

* Refer to the notes at the end of the tables of this range

MICHELIN AXIOBIB 2

Tire specifications and pressure table (bar & psi). Load per tire in kg*

Ø inches	Description	CAI	e mm	D mm	R' mm	RC mm	Recommended Rim		Acceptable Rim		Tube (Code)	75% internal volume (litres)		Tread depth (mm)	
34	VF 710/60R34 173D/169E TL NEW	757609	731	1727	754	5093	DW25B (A)		DW23B (A) (NRO) MW25B (A)			613		58	
Bar	0.4	0.6	0.8	0.9	1	1.1	1.2	1.3	1.4	1.5	1.6	1.7	1.8	1.9	2
Psi	6	9	12	13	15	16	17	19	20	22	23	25	26	28	29
10 km/h		3465	4125	4405	4690	4970	5255	5535	5815	6100	6380	6575	6765	6960	7150
30 km/h		3215	3825	4085	4350	4610	4870	5130	5395	5655	5915	6095	6275	6450	6630
65 km/h		3150	3750	4005	4265	4520	4775	5030	5290	5545	5800	5975	6150	6325	6500
65 km/h Dual	2330	2815	3300	3520	3740	3960	4180	4410	4645	4875	5105	5260	5415	5565	5720
70 km/h		2865	3350	3595	3840	4080	4325	4565	4805	5040	5280	5410	5540	5670	5800

Ø inches	Description	CAI	e mm	D mm	R' mm	RC mm	Recommended Rim		Acceptable Rim		Tube (Code)	75% internal volume (litres)		Tread depth (mm)	
38	VF 650/60R38 170D/167E TL	908973	668	1742	772	5145	DW23B (A)		DW20B (A) MW23B (A)		825	540		58	
Bar	0.4	0.6	0.8	0.9	1	1.1	1.2	1.3	1.4	1.5	1.6	1.7	1.8	1.9	2
Psi	6	9	12	13	15	16	17	19	20	22	23	25	26	28	29
10 km/h		3190	3795	4050	4305	4560	4815	5065	5320	5575	5830	6025	6215	6410	6600
30 km/h		2960	3520	3755	3990	4225	4465	4700	4935	5170	5405	5585	5765	5940	6120
65 km/h		2900	3450	3680	3915	4145	4375	4605	4840	5070	5300	5475	5650	5825	6000
65 km/h Dual	2140	2590	3035	3240	3445	3645	3850	4055	4260	4460	4665	4820	4975	5125	5280
70 km/h		2640	3085	3310	3535	3755	3980	4190	4405	4615	4825	4985	5145	5300	5460

Ø inches	Description	CAI	e mm	D mm	R' mm	RC mm	Recommended Rim		Acceptable Rim		Tube (Code)	75% internal volume (litres)		Tread depth (mm)	
38	VF 650/85R38 182D/179E TL	655949	680	2063	900	6088	DW23B (A)		DW20B (A) DW21B		804	857		63	
Bar	0.4	0.6	0.8	0.9	1	1.1	1.2	1.3	1.4	1.5	1.6	1.7	1.8	1.9	2
Psi	6	9	12	13	15	16	17	19	20	22	23	25	26	28	29
10 km/h		4675	5365	5760	6155	6550	6945	7340	7735	8130	8525	8730	8940	9145	9350
30 km/h		4335	4975	5340	5710	6075	6440	6805	7175	7540	7905	8095	8290	8480	8670
65 km/h		4250	4875	5235	5595	5955	6315	6670	7030	7390	7750	7940	8125	8315	8500
65 km/h Dual	3125	3710	4290	4605	4920	5230	5545	5865	6185	6500	6820	6985	7150	7315	7480
70 km/h		3870	4490	4805	5115	5425	5735	6065	6395	6725	7055	7230	7405	7575	7750

* Refer to the notes at the end of the tables of this range

MICHELIN AXIOBIB 2

Tire specifications and pressure table (bar & psi). Load per tire in kg*

Ø inches	Description	CAI	e mm	D mm	R' mm	RC mm	Recommended Rim	Acceptable Rim	Tube (Code)	75% internal volume (litres)	Tread depth (mm)				
38	VF 800/70R38 187D/184E TL	136377	821	2072	891	6096	DW27B (A)	DW25B (A)	804	1073	63				
Bar	0.4	0.6	0.8	0.9	1	1.1	1.2	1.3	1.4	1.5	1.6	1.7	1.8	1.9	2
Psi	6	9	12	13	15	16	17	19	20	22	23	25	26	28	29
10 km/h	5365	6380	6820	7260	7700	8140	8580	9020	9460	9900	10105	10315	10520	10725	
30 km/h	4975	5915	6325	6730	7140	7550	7955	8365	8770	9180	9370	9565	9755	9945	
65 km/h	4875	5800	6200	6600	7000	7400	7800	8200	8600	9000	9190	9375	9565	9750	
65 km/h Dual	3630	4370	5105	5435	5765	6095	6425	6800	7175	7545	7920	8085	8250	8415	8580
70 km/h	4435	5170	5540	5910	6275	6645	7030	7420	7805	8190	8395	8595	8800	9000	

Ø inches	Description	CAI	e mm	D mm	R' mm	RC mm	Recommended Rim	Acceptable Rim	Tube (Code)	75% internal volume (litres)	Tread depth (mm)				
42	VF 710/60R42 176D/173E TL	941770	730	1885	830	5574	DW25B (A)	DW23B (A) MW25B (A)	802	710	58				
Bar	0.4	0.6	0.8	0.9	1	1.1	1.2	1.3	1.4	1.5	1.6	1.7	1.8	1.9	2
Psi	6	9	12	13	15	16	17	19	20	22	23	25	26	28	29
10 km/h	3795	4540	4865	5195	5520	5845	6170	6495	6825	7150	7315	7480	7645	7810	
30 km/h	3520	4210	4515	4815	5120	5420	5725	6025	6330	6630	6785	6935	7090	7240	
65 km/h	3450	4125	4420	4720	5015	5315	5610	5905	6205	6500	6650	6800	6950	7100	
65 km/h Dual	2550	3090	3630	3890	4150	4405	4665	4930	5195	5455	5720	5855	5985	6120	6250
70 km/h	3140	3700	3985	4265	4545	4825	5100	5370	5645	5915	6050	6190	6325	6460	

Ø inches	Description	CAI	e mm	D mm	R' mm	RC mm	Recommended Rim	Acceptable Rim	Tube (Code)	75% internal volume (litres)	Tread depth (mm)				
42	VF 650/65R42 174D/171E TL	387916	666	1920	847	5680	DW23B (A)	DW20B (A) DW21B(A)	802	643	58				
Bar	0.4	0.6	0.8	0.9	1	1.1	1.2	1.3	1.4	1.5	1.6	1.7	1.8	1.9	2
Psi	6	9	12	13	15	16	17	19	20	22	23	25	26	28	29
10 km/h	3685	4400	4675	4950	5225	5500	5775	6050	6325	6600	6795	6985	7180	7370	
30 km/h	3415	4080	4335	4590	4845	5100	5355	5610	5865	6120	6300	6480	6655	6835	
65 km/h	3350	4000	4250	4500	4750	5000	5250	5500	5750	6000	6175	6350	6525	6700	
65 km/h Dual	2465	2995	3520	3740	3960	4180	4400	4620	4840	5060	5280	5435	5590	5740	5895
70 km/h	3075	3580	3835	4085	4340	4590	4820	5050	5275	5505	5665	5830	5990	6150	

* Refer to the notes at the end of the tables of this range

MICHELIN AXIOBIB 2

Tire specifications and pressure table (bar & psi). Load per tire in kg*

Ø inches	Description	CAI	e mm	D mm	R' mm	RC mm	Recommended Rim		Acceptable Rim		Tube (Code)	75% internal volume (litres)		Tread depth (mm)	
42	VF 710/70R42 182D/179E TL	523668	731	2066	906	6104	DW25B (A)	DW23B (A) MW25B (A)	802	867	63				
Bar	0.4	0.6	0.8	0.9	1	1.1	1.2	1.3	1.4	1.5	1.6	1.7	1.8	1.9	2
Psi	6	9	12	13	15	16	17	19	20	22	23	25	26	28	29
10 km/h	4675	5500	5880	6255	6635	7015	7390	7770	8145	8525	8730	8940	9145	9350	
30 km/h	4335	5100	5450	5800	6150	6505	6855	7205	7555	7905	8095	8290	8480	8670	
65 km/h	4250	5000	5345	5690	6030	6375	6720	7065	7405	7750	7940	8125	8315	8500	
65 km/h Dual	3125	3765	4400	4685	4975	5260	5545	5865	6185	6500	6820	6985	7150	7315	7480
70 km/h	3870	4490	4805	5115	5425	5735	6065	6395	6725	7055	7230	7405	7575	7750	

Ø inches	Description	CAI	e mm	D mm	R' mm	RC mm	Recommended Rim		Acceptable Rim		Tube (Code)	75% internal volume (litres)		Tread depth (mm)	
42	VF 710/75R42 184D/180E TL	259635	737	2153	950	6370	DW25B (A)				802	945	65		
Bar	0.4	0.6	0.8	0.9	1	1.1	1.2	1.3	1.4	1.5	1.6	1.7	1.8	1.9	2
Psi	6	9	12	13	15	16	17	19	20	22	23	25	26	28	29
10 km/h	4950	5760	6175	6590	7005	7420	7830	8245	8660	9075	9280	9490	9695	9900	
30 km/h	4590	5340	5725	6110	6495	6880	7260	7645	8030	8415	8605	8800	8990	9180	
65 km/h	4500	5235	5610	5990	6365	6745	7120	7495	7875	8250	8440	8625	8815	9000	
65 km/h Dual	3300	3985	4665	4975	5280	5590	5895	6235	6580	6920	7260	7425	7590	7755	7920
70 km/h	4145	4820	5160	5495	5835	6170	6530	6885	7245	7600	7700	7800	7900	8000	

Ø inches	Description	CAI	e mm	D mm	R' mm	RC mm	Recommended Rim		Acceptable Rim		Tube (Code)	75% internal volume (litres)		Tread depth (mm)	
42	VF 900/60R42 189D/185E TL NEW	428922	881	2158	942	6357	DW30B (A)	DW28B (A)				1230	64		
Bar	0.4	0.6	0.8	0.9	1	1.1	1.2	1.3	1.4	1.5	1.6	1.7	1.8	1.9	2
Psi	6	9	12	13	15	16	17	19	20	22	23	25	26	28	29
10 km/h	5550	6475	6940	7400	7865	8325	8790	9250	9715	10175	10465	10755	11040	11330	
30 km/h	5145	6005	6435	6865	7290	7720	8150	8580	9005	9435	9705	9970	10240	10505	
65 km/h	5045	5885	6305	6725	7145	7565	7985	8410	8830	9250	9515	9775	10040	10300	
65 km/h Dual	3665	4440	5180	5550	5920	6290	6660	7030	7400	7770	8140	8370	8605	8835	9065
70 km/h	4590	5355	5740	6120	6505	6885	7270	7655	8035	8420	8630	8835	9045	9250	

* Refer to the notes at the end of the tables of this range

MICHELIN AXIOBIB 2

Tire specifications and pressure table (bar & psi). Load per tire in kg*

Ø inches	Description	CAI	e mm	D mm	R' mm	RC mm	Recommended Rim		Acceptable Rim		Tube (Code)	75% internal volume (litres)	Tread depth (mm)
42	VF 650/85R42 183D/180E TL	530764	670	2164	948	6393	DW23B (A)	DW21B(A)	802	914	61		
Bar	0.6 0.8 0.9	1 1.1 1.2	1.3 1.4 1.5	1.6 1.7 1.8	1.9 2								
Psi	9 12 13	15 16 17	19 20 22	23 25 26	28 29								
10 km/h	4815 5665 6055	6450 6840 7235	7625 8015 8410	8800 9005 9215	9420 9625								
30 km/h	4465 5255 5620	5980 6345 6710	7070 7435 7795	8160 8350 8545	8735 8925								
65 km/h	4375 5150 5505	5865 6220 6575	6930 7290 7645	8000 8190 8375	8565 8750								
65 km/h Dual	3850 4400 4675	4950 5225 5500	5775 6050 6325	6600 6875 7150	7425 7700								
70 km/h	4015 4665 4990	5315 5640 5965	6310 6655 7000	7345 7515 7690	7860 8030								

Ø inches	Description	CAI	e mm	D mm	R' mm	RC mm	Recommended Rim		Acceptable Rim		Tube (Code)	75% internal volume (litres)	Tread depth (mm)
44	VF 750/70R44 186D/183E TL	681569	763	2180	956	6438	DW25B (A)	MW25B (A) MW24B (A) DW24B (A)				1016	64
Bar	0.4 0.6 0.8	0.9 1 1.1	1.2 1.3 1.4	1.5 1.6 1.7	1.8 1.9 2								
Psi	6 9 12	13 15 16	17 19 20	22 23 25	26 28 29								
10 km/h	5225 6090 6530	6975 7415 7860	8300 8740 9185	9625 9830 10040	10245 10450								
30 km/h	4845 5645 6055	6465 6875 7285	7695 8105 8515	8925 9115 9310	9500 9690								
65 km/h	4750 5535 5935	6340 6740 7145	7545 7945 8350	8750 8940 9125	9315 9500								
65 km/h Dual	3410 4105 4795	5160 5525 5885	6250 6615 6975	7340 7700 7865	8030 8195 8360								
70 km/h	4375 5095 5460	5820 6180 6540	6920 7300 7680	8060 8235 8405	8580 8750								

***IMPORTANT:**

The inflation pressure must always be appropriate for the load per tire, the speed of travel and the work to be done. Our recommendations above are provided subject to changes made after the date of publication of these tables (July 2020). Technical data is subject to change without prior notice.

- For plowing and other field applications subject to high torque, use the 30 km/h column.
- When using single tire configuration:
 - add 0.4 bar for use on slopes of more than 20%
 - add 0.4 bar for intense road use exceeding 50% of time on road
- (NRO) - Narrow rim option - when using NRO add 0.2 bar.
- 10 km/h LT (Low Torque) (max speed 10 km/h).

TRACTORS

HIGH POWER



MICHELIN AXIOBIB

IMPROVED TRACTION
& SOIL PROTECTION
FOR VERY HIGH-POWERED
TRACTORS



FOR HIGH-POWERED TRACTORS **250 HP AND OVER**



IMPROVED FLEXION STANDARD (IF)

Tire designed to operate at 20% higher rated load than standard metric tires at the same inflation pressure.



BETTER YIELDS +4% /Year⁽¹⁾



FUEL SAVINGS

up to **15%** when working in the field⁽²⁾



+11% TRACTION

with AXIOBIB IF 710/70R42 vs standard 710/70R42



SOIL PROTECTION

thanks to low pressure up to 20% less versus standard radials

(1) Harper Adams University 2014/2016

(2) In average, observed versus standard equipment during field demonstrations.

SIZES

IF 600/70R30 159A8/156B TL
IF 600/70R30 159D TL
IF 620/75R30 164D TL
IF 650/75R30 166D TL
IF 480/70R34 150A8/147B TL
IF 650/60R34 165D TL
IF 710/60R34 164D TL

IF 650/65R34 161D TL
IF 650/65R38 169D TL
IF 710/60R38 172D TL
IF 650/85R38 179D TL
IF 650/85R38 179A8/176B TL
IF 800/70R38 179D TL
IF 800/70R38 179A8/176B TL

IF 710/85R38 178D TL
IF 710/70R42 179A8/176B TL
IF 710/70R42 179D TL
IF 900/60R42 186D TL
IF 710/75R42 176D TL
IF 750/75R46 186D TL
IF 900/65R46 190D TL

MICHELIN AXIOBIB

Tire specifications and pressure table (bar & psi). Load per tire in kg*

Ø inches	Description	CAI	e mm	D mm	R' mm	RC mm	Recommended Rim	Acceptable Rim	Tube (Code)	75% internal volume (litres)	Tread depth (mm)
30	IF 600/70R30 159A8/156B TL <i>South America</i>	338729	600	1585	695	4683	DW21B (A)	DW20B (A)	737	450	56
Bar	0.4 0.6 0.8	1	1.2	1.4	1.6						
Psi	6 9 12	15	17	20	23						
10 km/h		3220	3710	4200	4615	5030					
30 km/h		2910	3355	3795	4175	4550					
40 km/h		2800	3225	3650	4015	4375					
40 km/h Dual	1760 2115	2465	2840	3210	3530	3850					
50 km/h		2550	2885	3220	3610	4000					

Ø inches	Description	CAI	e mm	D mm	R' mm	RC mm	Recommended Rim	Acceptable Rim	Tube (Code)	75% internal volume (litres)	Tread depth (mm)
30	IF 600/70R30 159D TL	280086	613	1585	695	4683	DW21B (A)	DW20B (A)	737	450	56
Bar	0.4 0.6 0.8	1	1.2	1.4	1.6						
Psi	6 9 12	15	17	20	23						
10 km/h		3220	3710	4200	4615	5030					
30 km/h		2910	3355	3795	4175	4550					
65 km/h		2800	3225	3650	4015	4375					
65 km/h Dual	1760 2110	2460	2835	3210	3530	3850					

Ø inches	Description	CAI	e mm	D mm	R' mm	RC mm	Recommended Rim	Acceptable Rim	Tube (Code)	75% internal volume (litres)	Tread depth (mm)
30	IF 620/75R30 164D TL	668406	659	1670	728	4927	DW23B (A)	DW21B (A) MW23B(A)	737	570	58
Bar	0.4 0.6 0.8	1	1.2	1.4	1.6						
Psi	6 9 12	15	17	20	23						
10 km/h		3620	4110	4600	5175	5750					
30 km/h		3275	3720	4160	4680	5200					
65 km/h		3150	3575	4000	4500	5000					
65 km/h Dual	1970 2370	2770	3145	3520	3960	4400					

Ø inches	Description	CAI	e mm	D mm	R' mm	RC mm	Recommended Rim	Acceptable Rim	Tube (Code)	75% internal volume (litres)	Tread depth (mm)
30	IF 650/75R30 166D TL	828322	679	1721	745	5071	DW23B (A)	MW23B(A)		638	57
Bar	0.4 0.6 0.8	1	1.2	1.4	1.6						
Psi	6 9 12	15	17	20	23						
10 km/h		3965	4500	5030	5565	6095					
30 km/h		3590	4070	4550	5030	5510					
65 km/h		3450	3915	4375	4840	5300					
65 km/h Dual	2140 2590	3040	3445	3850	4255	4660					

* Refer to the notes at the end of the tables of this range

MICHELIN AXIOBIB

Tire specifications and pressure table (bar & psi). Load per tire in kg*

Ø inches	Description	CAI	e mm	D mm	R' mm	RC mm	Recommended Rim	Acceptable Rim	Tube (Code)	75% internal volume (litres)	Tread depth (mm)
34	IF 480/70R34 150A8/147B TL <i>South America</i>	324646	482	1590	705	4732	W15L (NRO)	DW14L W14L DW15L (NRO) DW16A W16A W16L DW15A (NRO) W15A (NRO)	704	304	52
Bar	0.4 0.6 0.8	1	1.2	1.4	1.6						
Psi	6 9 12	15	17	20	23						
10 km/h		2440	2790	3135	3495	3850					
30 km/h		2205	2520	2835	3160	3485					
40 km/h		2120	2425	2725	3040	3350					
40 km/h Dual	1320 1595	1865	2135	2400	2675	2950					
50 km/h		1930	2205	2480	2780	3075					

Ø inches	Description	CAI	e mm	D mm	R' mm	RC mm	Recommended Rim	Acceptable Rim	Tube (Code)	75% internal volume (litres)	Tread depth (mm)	
34	IF 650/60R34 165D TL	100511	633	1661	745	4933	DW23B (A)	DW21B (A) DW24B (A)	823	500	58	
Bar	0.4 0.6 0.8	1	1.2	1.4	1.6	1.7 1.8	1.9 2	2.1 2.2 2.3 2.4				
Psi	6 9 12	15	17	20	23	25 26	28 29	30 32 33 35				
10 km/h		3220	3675	4130	4580	5030	5145 5255	5370 5480	5590	5700	5810	5920
30 km/h		2910	3325	3735	4145	4550	4650 4755	4855 4955	5055	5155	5255	5355
65 km/h		2800	3195	3590	3985	4375	4475 4570	4670 4765	4860	4960	5055	5150
65 km/h Dual	1760 2115	2465	2815	3160	3505	3850	3935 4020	4105 4190	4275	4360	4445	4530

Ø inches	Description	CAI	e mm	D mm	R' mm	RC mm	Recommended Rim	Acceptable Rim	Tube (Code)	75% internal volume (litres)	Tread depth (mm)
34	IF 710/60R34 164D TL	712503	708	1696	756	5030	DW25B (A)			615	58
Bar	0.4 0.6 0.8	1	1.2	1.4	1.6						
Psi	6 9 12	15	17	20	23						
10 km/h		3620	4185	4745	5250	5750					
30 km/h		3275	3785	4290	4745	5200					
65 km/h		3150	3640	4125	4565	5000					
65 km/h Dual	1970 2370	2770	3200	3630	4015	4400					

* Refer to the notes at the end of the tables of this range

MICHELIN AXIOBIB

Tire specifications and pressure table (bar & psi). Load per tire in kg*

Ø inches	Description	CAI	e mm	D mm	R' mm	RC mm	Recommended Rim	Acceptable Rim	Tube (Code)	75% internal volume (litres)	Tread depth (mm)
34	IF 650/65R34 161D TL	711975	653	1721	764	5099	DW23B (A)		823	555	58
Bar	0.4	0.6	0.8	1	1.2	1.4	1.6				
Psi	6	9	12	15	17	20	23				
10 km/h			3535	4070	4600	4960	5320				
30 km/h			3200	3680	4160	4485	4810				
65 km/h			3075	3540	4000	4315	4625				
65 km/h Dual	1920	2315	2710	3115	3520	3795	4070				

Ø inches	Description	CAI	e mm	D mm	R' mm	RC mm	Recommended Rim	Acceptable Rim	Tube (Code)	75% internal volume (litres)	Tread depth (mm)				
38	IF 650/65R38 169D TL	508421	649	1826	833	5446	DW23B (A)	MW21B(A) DW21B (A)	825	599	58				
Bar	0.4	0.6	0.8	1	1.2	1.4	1.6	1.7	1.8	1.9	2	2.1	2.2	2.3	2.4
Psi	6	9	12	15	17	20	23	25	26	28	29	30	32	33	35
10 km/h			3735	4240	4745	5175	5605	5740	5875	6005	6140	6275	6405	6540	6670
30 km/h			3380	3835	4290	4680	5070	5190	5315	5435	5555	5675	5795	5910	6030
65 km/h			3250	3690	4125	4500	4875	4990	5110	5225	5340	5455	5570	5685	5800
65 km/h Dual	2025	2445	2860	3245	3630	3960	4290	4390	4495	4595	4695	4795	4900	5000	5100

Ø inches	Description	CAI	e mm	D mm	R' mm	RC mm	Recommended Rim	Acceptable Rim	Tube (Code)	75% internal volume (litres)	Tread depth (mm)				
38	IF 710/60R38 172D TL	220975	710	1844	834	5486	DW25B (A)		825	661	58				
Bar	0.4	0.6	0.8	1	1.2	1.4	1.6	1.7	1.8	1.9	2	2.1	2.2	2.3	2.4
Psi	6	9	12	15	17	20	23	25	26	28	29	30	32	33	35
10 km/h			3850	4415	4975	5535	6095	6240	6385	6525	6670	6815	6960	7100	7245
30 km/h			3485	3995	4500	5005	5510	5640	5770	5900	6030	6160	6290	6420	6550
65 km/h			3350	3840	4325	4815	5300	5425	5550	5675	5800	5925	6050	6175	6300
65 km/h Dual	2360	2680	3000	3410	3815	4220	4625	4740	4855	4970	5085	5200	5315	5430	5545

Ø inches	Description	CAI	e mm	D mm	R' mm	RC mm	Recommended Rim	Acceptable Rim	Tube (Code)	75% internal volume (litres)	Tread depth (mm)				
38	IF 650/85R38 179D TL	084900	692	2050	913	6078	DW23B (A)	MW23B (A)	804	900	63				
Bar	0.4	0.6	0.8	1	1.2	1.4	1.6	1.7	1.8	1.9	2	2.1	2.2	2.3	2.4
Psi	6	9	12	15	17	20	23	25	26	28	29	30	32	33	35
10 km/h			4890	5580	6265	6985	7705	7880	8050	8225	8395	8525	8655	8785	8915
30 km/h			4420	5045	5670	6320	6970	7125	7280	7435	7590	7710	7825	7945	8060
65 km/h			4250	4850	5450	6075	6700	6850	7000	7150	7300	7415	7525	7640	7750
65 km/h Dual	2640	3190	3740	4270	4800	5350	5900	6030	6160	6290	6420	6520	6620	6720	6820

* Refer to the notes at the end of the tables of this range

MICHELIN AXIOBIB

Tire specifications and pressure table (bar & psi). Load per tire in kg*

Ø inches	Description				CAI	e mm	D mm	R' mm	RC mm	Recommended Rim		Acceptable Rim		Tube (Code)	75% internal volume (litres)			Tread depth (mm)
38	IF 650/85R38 179A8/176B TL <i>South America</i>				075523	692	2050	913	6078	DW23B (A)		MW23B (A)		804	900			63
Bar	0.4	0.6	0.8	1	1.2	1.4	1.6	1.7	1.8	1.9	2	2.1	2.2	2.3	2.4			
Psi	6	9	12	15	17	20	23	25	26	28	29	30	32	33	35			
10 km/h					4890	5580	6265	6985	7705	7855	8010	8160	8310	8460	8615	8765	8915	
30 km/h					4420	5045	5670	6320	6970	7105	7245	7380	7515	7650	7790	7925		8060
40 km/h					4250	4850	5450	6075	6700	6830	6965	7095	7225	7355	7490	7620		7750
40 km/h Dual	2640	3190	3740	4270	4795	5345	5895	6010	6130	6245	6360	6475	6590	6705	6820			
50 km/h					3870	4415	4960	5530	6095	6215	6335	6455	6575	6705	6840	6970		7100

Ø inches	Description				CAI	e mm	D mm	R' mm	RC mm	Recommended Rim		Acceptable Rim		Tube (Code)	75% internal volume (litres)			Tread depth (mm)
38	IF 800/70R38 179D TL				528166	810	2067	894	6089	DW27B (A)				804	1088			63
Bar	0.4	0.6	0.8	1	1.2	1.4	1.6											
Psi	6	9	12	15	17	20	23											
10 km/h					5605	6425	7245	8080	8915									
30 km/h					5070	5810	6550	7305	8060									
65 km/h					4875	5590	6300	7025	7750									
65 km/h Dual	3040	3665	4290	4915	5540	6180	6820											

Ø inches	Description				CAI	e mm	D mm	R' mm	RC mm	Recommended Rim		Acceptable Rim		Tube (Code)	75% internal volume (litres)			Tread depth (mm)
38	IF 800/70R38 179A8/176B TL <i>South America</i>				748361	810	2067	894	6089	DW27B (A)				804	1088			63
Bar	0.4	0.6	0.8	1	1.2	1.4	1.6											
Psi	6	9	12	15	17	20	23											
10 km/h					5605	6425	7245	8080	8915									
30 km/h					5070	5810	6550	7305	8060									
40 km/h					4875	5590	6300	7025	7750									
40 km/h Dual	3035	3665	4290	4920	5545	6185	6820											
50 km/h					4435	5085	5735	6420	7100									

Ø inches	Description				CAI	e mm	D mm	R' mm	RC mm	Recommended Rim		Acceptable Rim		Tube (Code)	75% internal volume (litres)			Tread depth (mm)
38	IF 710/85R38 178D TL				992951	734	2159	937	6365	DW25B (A)		MW25B (A)		804	1088			65
Bar	0.4	0.6	0.8	1	1.2	1.4	1.6											
Psi	6	9	12	15	17	20	23											
10 km/h					5605	6340	7070	7850	8625									
30 km/h					5070	5735	6395	7100	7800									
65 km/h					4875	5515	6150	6825	7500									
65 km/h Dual	3040	3665	4290	4850	5410	6005	6600											

* Refer to the notes at the end of the tables of this range

MICHELIN AXIOBIB

Tire specifications and pressure table (bar & psi). Load per tire in kg*

Ø inches	Description			CAI	e mm	D mm	R' mm	RC mm	Recommended Rim		Acceptable Rim		Tube (Code)	75% internal volume (litres)		Tread depth (mm)
42	IF 710/70R42 179A8/176B TL <i>South America</i>			339858	742	2050	919	6089	DW25B (A)		MW25B (A) DW23B		802	867		63
Bar	0.4	0.6	0.8	1	1.2	1.4	1.6	1.7	1.8	1.9	2	2.1	2.2	2.3	2.4	
Psi	6	9	12	15	17	20	23	25	26	28	29	30	32	33	35	
10 km/h				4890	5580	6265	6985	7705	7855	8010	8160	8310	8460	8615	8765	8915
30 km/h				4420	5045	5670	6320	6970	7105	7245	7380	7515	7650	7790	7925	8060
40 km/h				4250	4850	5450	6075	6700	6830	6965	7095	7225	7355	7490	7620	7750
40 km/h Dual	2640	3190		3740	4270	4795	5345	5895	6010	6130	6245	6360	6475	6590	6705	6820
50 km/h				3870	4415	4960	5530	6095	6215	6335	6455	6575	6705	6840	6970	7100

Ø inches	Description			CAI	e mm	D mm	R' mm	RC mm	Recommended Rim		Acceptable Rim		Tube (Code)	75% internal volume (litres)		Tread depth (mm)
42	IF 710/70R42 179D TL			771752	742	2062	919	6115	DW25B (A)		MW25B (A) DW23B		802	870		63
Bar	0.4	0.6	0.8	1	1.2	1.4	1.6	1.7	1.8	1.9	2	2.1	2.2	2.3	2.4	
Psi	6	9	12	15	17	20	23	25	26	28	29	30	32	33	35	
10 km/h				4890	5580	6265	6985	7705	7880	8050	8225	8395	8525	8655	8785	8915
30 km/h				4420	5045	5670	6320	6970	7125	7280	7435	7590	7710	7825	7945	8060
65 km/h				4250	4850	5450	6075	6700	6850	7000	7150	7300	7415	7525	7640	7750
65 km/h Dual	2640	3190		3740	4270	4800	5350	5900	6030	6160	6290	6420	6520	6620	6720	6820

Ø inches	Description			CAI	e mm	D mm	R' mm	RC mm	Recommended Rim		Acceptable Rim		Tube (Code)	75% internal volume (litres)		Tread depth (mm)
42	IF 900/60R42 186D TL			111950	881	2123	952	6304	DW30B (A)					1230		65
Bar	0.4	0.6	0.8	1	1.2	1.4	1.6	1.7	1.8	1.9	2	2.1	2.2	2.3	2.4	
Psi	6	9	12	15	17	20	23	25	26	28	29	30	32	33	35	
10 km/h				5750	6615	7475	8340	9200	9415	9635	9850	10065	10280	10495	10710	10925
30 km/h				5200	5980	6760	7540	8320	8515	8710	8905	9100	9295	9490	9685	9880
65 km/h				5000	5750	6500	7250	8000	8190	8375	8565	8750	8940	9125	9315	9500
65 km/h Dual	3210	3805		4400	5060	5720	6380	7040	7205	7370	7535	7700	7865	8030	8195	8360

Ø inches	Description			CAI	e mm	D mm	R' mm	RC mm	Recommended Rim		Acceptable Rim		Tube (Code)	75% internal volume (litres)		Tread depth (mm)
42	IF 710/75R42 176D TL			037489	715	2161	954	6395	DW25B (A)				802	953		66
Bar	0.4	0.6	0.8	1	1.2	1.4	1.6									
Psi	6	9	12	15	17	20	23									
10 km/h				5190	5935	6680	7425	8165								
30 km/h				4695	5370	6040	6715	7385								
65 km/h				4515	5165	5810	6455	7100								
65 km/h Dual	2845	3415		3980	4550	5115	5685	6250								

* Refer to the notes at the end of the tables of this range

MICHELIN AXIOBIB

Tire specifications and pressure table (bar & psi). Load per tire in kg*

Ø inches	Description		CAI	e mm	D mm	R' mm	RC mm	Recommended Rim		Acceptable Rim		Tube (Code)	75% internal volume (litres)		Tread depth (mm)
46	IF 750/75R46 186D TL		487001	761	2287	1043	6819	DW25B (A)					1147	71	
Bar	0.4	0.6	0.8	1	1.2	1.4	1.6	1.7	1.8	1.9	2	2.1	2.2	2.3	2.4
Psi	6	9	12	15	17	20	23	25	26	28	29	30	32	33	35
10 km/h			5920	6700	7475	8340	9200	9415	9635	9850	10065	10280	10495	10710	10925
30 km/h			5355	6060	6760	7540	8320	8515	8710	8905	9100	9295	9490	9685	9880
65 km/h			5150	5825	6500	7250	8000	8190	8375	8565	8750	8940	9125	9315	9500
65 km/h Dual	3210	3870	4530	5125	5720	6380	7040	7205	7370	7535	7700	7865	8030	8195	8360

Ø inches	Description		CAI	e mm	D mm	R' mm	RC mm	Recommended Rim		Acceptable Rim		Tube (Code)	75% internal volume (litres)		Tread depth (mm)
46	IF 900/65R46 190D TL		162365	915	2322	1038	6888	MW30B (A)					1450	71	
Bar	0.4	0.6	0.8	1	1.2	1.4	1.6	1.7	1.8	1.9	2	2.1	2.2	2.3	2.4
Psi	6	9	12	15	17	20	23	25	26	28	29	30	32	33	35
10 km/h			6670	7650	8625	9345	10065	10330	10595	10860	11125	11390	11660	11925	12190
30 km/h			6030	6915	7800	8450	9100	9340	9580	9820	10060	10300	10545	10785	11025
65 km/h			5800	6650	7500	8125	8750	8980	9215	9445	9675	9905	10140	10370	10600
65 km/h Dual	3630	4370	5105	5855	6600	7150	7700	7905	8110	8310	8515	8720	8925	9125	9330

***IMPORTANT:**

The inflation pressure must always be appropriate for the load per tire, the speed of travel and the work to be done. Our recommendations above are provided subject to changes made after the date of publication of these tables (July 2020). Technical data is subject to change without prior notice.

- For plowing and other field applications subject to high torque, use the 30 km/h column.
- When using single tire configuration:
 - add 0.4 bar for use on slopes of more than 20%
 - add 0.4 bar for intense road use exceeding 50% of time on road
- 10 km/h LT (Low Torque) (max speed 10 km/h).

TRACTORS

HIGH POWER



MICHELIN MACHXBIB

EXCEPTIONAL VALUE
& VERSALITY FOR
HIGH-POWERED TRACTORS



FOR HIGH-POWERED TRACTORS **160 HP AND OVER**



VERSATILE, ideal for road transport & efficient in the field:

- speed of up to 65 km/h⁽¹⁾
- load capacity in the field
- damage resistance
- excellent tractive performance



4% FUEL SAVINGS, 1 litre/hr compared to the main market competitor⁽²⁾
(for a consumption on the road of 25 l/hr)



PROVEN **CASING ROBUSTNESS**

(1) When authorized by the laws in force in the country - depending on the size

(2) Analytic Test at MICHELIN Tracks Ladoux Centre, in June 2014 comparing Fuel Consumption of 710/70R42 Michelin MachXBib and 710/70R42 Trelleborg TM900

SIZES

600/65R28 154A8/154B TL

600/65R28 154D/150E TL **NEW**

600/70R28 157D/154E TL **NEW**

600/70R28 157A8/157B TL

710/55R30 153D TL

600/70R30 158D TL **NEW**

600/70R30 152D TL

680/75R32 164A8/161B TL

650/60R34 159D/155E TL

650/65R34 161D/157E TL

650/75R38 169A8/169B TL

710/70R38 171A8/171B TL

710/70R38 171D TL

650/85R38 173A8/173B TL

800/70R38 173D TL

900/50R42 168D TL

710/70R42 173D TL

710/75R42 175D/171E TL

620/70R46 162D TL **NEW**

620/70R46 162A8/162B TL

MICHELIN MACHXBIB

Tire specifications and pressure table (bar & psi). Load per tire in kg*

Ø inches	Description	CAI	e mm	D mm	R' mm	RC mm	Recommended Rim		Acceptable Rim		Tube (Code)	75% internal volume (litres)	Tread depth (mm)
28	600/65R28 154A8/154B TL	135288	615	1485	669	4415	DW20B (A)	DW18L W18L	717	425	51		
Bar	0.4 0.6 0.8	1 1.2 1.4	1.6 1.7 1.8	1.7 1.8 1.9	2 2.2 2.4	2.4 2.6 2.8							
Psi	6 9 12	15 17 20	23 25 26	28 29 32	35 38 41	45 50 55							
10 km/h		3150	3505	3855	4210	4390	4565	4745	4920	5275	5630		
25 km/h		2610	2925	3245	3560	3635	3710	3785	3860	4010	4160		
30 km/h	1610 1915 2215	2520	2825	3125	3430	3505	3575	3650	3720	3865	4010		
40 km/h		2490	2710	2930	3150	3225	3300	3375	3450	3600	3750		
40 km/h Dual	1320 1610 1900	2190	2385	2575	2770	2835	2905	2970	3035	3170	3300		
50 km/h			2710	2930	3150	3225	3300	3375	3450	3600	3750		

Ø inches	Description	CAI	e mm	D mm	R' mm	RC mm	Recommended Rim		Acceptable Rim		Tube (Code)	75% internal volume (litres)	Tread depth (mm)			
28	600/65R28 154D/150E TL NEW	429970	626	1494	671	4465	DW20B (A)	DW18L W18L DW21B(A)	717	405	54					
Bar	0.4 0.6 0.8	1 1.2 1.4	1.6 1.7 1.8	1.7 1.8 1.9	2 2.2 2.4	2.4 2.6 2.8										
Psi	6 9 12	15 17 20	23 25 26	28 29 32	35 38 41	45 50 55										
10 km/h		2250	2530	2810	3090	3445	3805	4160	4340	4520	4695	4875	5065	5250	5440	5625
30 km/h	1725 2040 2360	2675	2990	3310	3625	3710	3800	3885	3970	4145	4315					
40 km/h		1915	2220	2530	2835	3145	3450	3530	3615	3695	3780	3940	4105			
40 km/h Dual	1445 1710 1975	2240	2505	2770	3035	3110	3180	3255	3325	3470	3615					
50 km/h		1840	2135	2430	2720	3015	3310	3390	3470	3545	3625	3785	3940			
65 km/h		2060	2335	2605	2880	3150	3225	3300	3375	3450	3600	3750				

Ø inches	Description	CAI	e mm	D mm	R' mm	RC mm	Recommended Rim		Acceptable Rim		Tube (Code)	75% internal volume (litres)	Tread depth (mm)			
28	600/70R28 157D/154E TL NEW	211033	629	1571	703	4652	DW20B (A)	DW18L DW21B(A)	717	448	54					
Bar	0.4 0.6 0.8	1 1.2 1.4	1.6 1.7 1.8	1.7 1.8 1.9	2 2.2 2.4	2.4 2.6 2.8										
Psi	6 9 12	15 17 20	23 25 26	28 29 32	35 38 41	45 50 55										
10 km/h		2475	2800	3125	3450	3855	4260	4665	4870	5070	5275	5475	5655	5835	6010	6190
30 km/h	1900 2265 2630	2995	3355	3720	4085	4170	4250	4335	4415	4580	4745					
40 km/h		2135	2485	2835	3185	3535	3885	3965	4045	4120	4200	4360	4515			
40 km/h Dual	1590 1895 2200	2505	2810	3115	3420	3490	3560	3630	3700	3835	3975					
50 km/h		2050	2385	2720	3060	3395	3730	3805	3880	3955	4030	4180	4330			
65 km/h		2300	2615	2925	3240	3550	3620	3695	3765	3840	3980	4125				

* Refer to the notes at the end of the tables of this range

MICHELIN MACHXBIB

Tire specifications and pressure table (bar & psi). Load per tire in kg*

Ø inches	Description	CAI	e mm	D mm	R' mm	RC mm	Recommended Rim	Acceptable Rim	Tube (Code)	75% internal volume (litres)	Tread depth (mm)		
28	600/70R28 157A8/157B TL	395016	623	1586	701	4694	DW20B (A)	DW18L	717	495	53		
Bar	0.4	0.6	0.8	1	1.2	1.4	1.6	1.7	1.8	1.9	2	2.2	2.4
Psi	6	9	12	15	17	20	23	25	26	28	29	32	35
10 km/h				3470	3855	4245	4630	4825	5020	5215	5410	5800	6190
30 km/h	1770	2160	2560	2955	3355	3750	4150	4185	4215	4250	4280	4345	4410
40 km/h				2850	3200	3550	3900	3930	3960	3985	4015	4075	4130
40 km/h Dual	1435	1795	2150	2510	2815	3125	3430	3455	3480	3505	3535	3585	3635
50 km/h					3200	3550	3900	3930	3960	3985	4015	4075	4130

Ø inches	Description	CAI	e mm	D mm	R' mm	RC mm	Recommended Rim	Acceptable Rim	Tube (Code)	75% internal volume (litres)	Tread depth (mm)	
30	710/55R30 153D TL	992342	678	1518	668	4489	DW23B (A)			506	50	
Bar	0.4	0.6	0.8	1	1.2	1.4	1.6	1.7	1.8	1.9		
Psi	6	9	12	15	17	20	23	25	26	28		
10 km/h	2475	2960	3370	3775	4185	4590	5000	5160	5320	5480		
30 km/h	1900	2270	2655	3040	3430	3815	4200					
40 km/h		2165	2530	2900	3265	3635	4000					
40 km/h Dual	1590	1905	2225	2550	2870	3195	3515					
50 km/h		2075	2425	2775	3130	3480	3830					
65 km/h			2300	2650	2985	3315	3650					

Ø inches	Description	CAI	e mm	D mm	R' mm	RC mm	Recommended Rim	Acceptable Rim	Tube (Code)	75% internal volume (litres)	Tread depth (mm)				
30	600/70R30 158D TL NEW	566557	638	1604	717	4760	DW20B (A)	DW18L DW21B (A)	737	468	56				
Bar	0.4	0.6	0.8	1	1.2	1.4	1.6	1.7	1.8	1.9	2	2.2	2.4	2.6	2.8
Psi	6	9	12	15	17	20	23	25	26	28	29	32	35	38	41
10 km/h	2475	2830	3185	3540	3955	4375	4790	5000	5210	5415	5625	5815	6000	6190	6375
30 km/h	1900	2285	2665	3050	3435	3815	4200	4285	4375	4460	4545	4720	4890		
40 km/h		2190	2550	2910	3275	3635	3995	4080	4160	4245	4325	4490	4655		
40 km/h Dual	1590	1910	2230	2555	2875	3195	3515	3590	3660	3735	3805	3950	4095		
50 km/h		2100	2445	2795	3140	3490	3835	3915	3995	4070	4150	4310	4465		
65 km/h			2360	2685	3005	3325	3650	3725	3800	3875	3950	4100	4250		

* Refer to the notes at the end of the tables of this range

MICHELIN MACHXBIB

Tire specifications and pressure table (bar & psi). Load per tire in kg*

Ø inches	Description	CAI	e mm	D mm	R' mm	RC mm	Recommended Rim	Acceptable Rim	Tube (Code)	75% internal volume (litres)	Tread depth (mm)
30	600/70R30 152D TL	334318	613	1605	706	4745	DW20B (A)	DW18L	737	456	56
Bar	0.4	0.6	0.8	1	1.2	1.4	1.6	1.7	1.8	1.9	
Psi	6	9	12	15	17	20	23	25	26	28	
10 km/h	2500	3000	3250	3750	4175	4600	5025	5125	5230	5330	
30 km/h	1915	2300	2680	3060	3440	3820	4200				
40 km/h		2190	2550	2910	3275	3635	3995				
40 km/h Dual	1605	1930	2250	2565	2885	3200	3520				
50 km/h		2100	2445	2790	3140	3485	3830				
65 km/h			2335	2665	2960	3255	3550				

Ø inches	Description	CAI	e mm	D mm	R' mm	RC mm	Recommended Rim	Acceptable Rim	Tube (Code)	75% internal volume (litres)	Tread depth (mm)
32	680/75R32 164A8/161B TL <i>XM28</i>	123582	675	1865	819	5512	DW21B (A)	DW20B (A)	831	743	58
Bar	0.4	0.6	0.8	1	1.2	1.4	1.6	1.7	1.8	1.9	
Psi	6	9	12	15	17	20	23	25	26	28	
10 km/h	3230	4430	4900	5375	5845	6320	6790	7030	7265	7500	
30 km/h	2510	3480	3855	4230	4600	4975	5350				
40 km/h		3250	3600	3950	4300	4650	5000				
40 km/h Dual	1970	2860	3170	3475	3785	4090	4400				
50 km/h		3050	3365	3680	4000	4315	4630				

Ø inches	Description	CAI	e mm	D mm	R' mm	RC mm	Recommended Rim	Acceptable Rim	Tube (Code)	75% internal volume (litres)	Tread depth (mm)				
34	650/60R34 159D/155E TL	549996	659	1664	752	4950	DW21B (A)	DW20B (A) DW23B (A)	823	500	58				
Bar	0.4	0.6	0.8	1	1.2	1.4	1.6	1.7	1.8	1.9	2	2.2	2.4	2.6	2.8
Psi	6	9	12	15	17	20	23	25	26	28	29	32	35	38	41
10 km/h	2475	2800	3125	3450	3885	4320	4755	4975	5190	5410	5625	5860	6095	6330	6565
30 km/h	1900	2285	2665	3050	3435	3815	4200	4305	4410	4510	4615	4825	5030		
40 km/h		2190	2550	2910	3275	3635	3995	4095	4195	4295	4395	4590	4790		
40 km/h Dual	1590	1910	2230	2555	2875	3195	3515	3605	3690	3780	3865	4040	4215		
50 km/h		2100	2445	2795	3140	3490	3835	3930	4025	4120	4215	4405	4595		
65 km/h			2300	2640	2975	3310	3650	3740	3830	3920	4015	4195	4375		
70 km/h			2095	2400	2710	3015	3320	3390	3460	3530	3600	3735	3875		

* Refer to the notes at the end of the tables of this range

MICHELIN MACHXBIB

Tire specifications and pressure table (bar & psi). Load per tire in kg*

Ø inches	Description	CAI	e mm	D mm	R' mm	RC mm	Recommended Rim	Acceptable Rim	Tube (Code)	75% internal volume (litres)	Tread depth (mm)				
34	650/65R34 161D/157E TL	817386	666	1726	779	5133	DW21B (A)	DW20B (A) DW23B (A)	823	555	58				
Bar	0.4 0.6 0.8 1 1.2 1.4 1.6 1.7 1.8 1.9 2 2.2 2.4 2.6 2.8														
Psi	6 9 12 15 17 20 23 25 26 28 29 32 35 38 41														
10 km/h	2700	3090	3475	3865	4290	4720	5145	5360	5575	5785	6000	6235	6470	6705	6940
30 km/h	2070	2470	2865	3265	3660	4055	4455	4565	4670	4780	4890	5105	5320		
40 km/h		2385	2755	3130	3500	3875	4245	4350	4450	4555	4655	4860	5065		
40 km/h Dual	1735	2070	2400	2735	3070	3400	3735	3825	3915	4005	4095	4275	4455		
50 km/h		2290	2645	3000	3360	3715	4070	4170	4265	4365	4465	4660	4855		
65 km/h			2575	2900	3225	3550	3875	3970	4065	4155	4250	4440	4625		
70 km/h			2345	2640	2935	3230	3525	3600	3675	3750	3825	3975	4125		

Ø inches	Description	CAI	e mm	D mm	R' mm	RC mm	Recommended Rim	Acceptable Rim	Tube (Code)	75% internal volume (litres)	Tread depth (mm)				
38	650/75R38 169A8/169B TL	219467	664	1948	880	5761	DW23B (A)	MW23B (A)	804	731	61				
Bar	0.4 0.6 0.8 1 1.2 1.4 1.6 1.7 1.8 1.9 2 2.2 2.4 2.6 2.8														
Psi	6 9 12 15 17 20 23 25 26 28 29 32 35 38 41														
10 km/h	3360	4150	4940	5730	6050	6370	6690	6860	7025	7195	7360	7695	8030	8365	8700
30 km/h	2410	3075	3745	4410	4680	4950	5220	5345	5470	5590	5715	5965	6210		
40 km/h		2725	3435	4140	4385	4630	4875	4990	5105	5220	5340	5570	5800		
40 km/h Dual	1965	2525	3085	3645	3860	4075	4290	4390	4495	4595	4700	4900	5105		
50 km/h		2725	3435	4140	4385	4630	4875	4990	5105	5220	5340	5570	5800		

Ø inches	Description	CAI	e mm	D mm	R' mm	RC mm	Recommended Rim	Acceptable Rim	Tube (Code)	75% internal volume (litres)	Tread depth (mm)				
38	710/70R38 171A8/171B TL <i>South America</i>	089862	713	1950	877	5794	DW23B (A)	MW23B (A) DW25B (A) MW25B (A)	804	815	62				
Bar	0.4 0.6 0.8 1 1.2 1.4 1.6 1.7 1.8 1.9 2 2.2 2.4 2.6 2.8														
Psi	6 9 12 15 17 20 23 25 26 28 29 32 35 38 41														
10 km/h	2600	3185	3765	4350	5070	5790	6510	6870	7230	7590	7950	8270	8590	8910	9230
30 km/h	2600	3110	3625	4135	4645	5160	5670	5785	5900	6010	6125	6355	6580		
40 km/h		2900	3385	3865	4345	4820	5300	5405	5515	5620	5725	5940	6150		
40 km/h Dual	2140	2560	2980	3400	3820	4240	4660	4755	4850	4940	5035	5225	5410		
50 km/h		2900	3385	3865	4345	4820	5300	5405	5515	5620	5725	5940	6150		

* Refer to the notes at the end of the tables of this range

MICHELIN MACHXBIB

Tire specifications and pressure table (bar & psi). Load per tire in kg*

Ø inches	Description	CAI	e mm	D mm	R' mm	RC mm	Recommended Rim	Acceptable Rim	Tube (Code)	75% internal volume (litres)	Tread depth (mm)				
38	710/70R38 171D TL	708197	713	1973	871	5804	DW23B (A)	MW23B (A) DW25B (A) MW25B (A)	804	811	62				
Bar	0.4	0.6	0.8	1	1.2	1.4	1.6	1.7	1.8	1.9	2	2.2	2.4	2.6	2.8
Psi	6	9	12	15	17	20	23	25	26	28	29	32	35	38	41
10 km/h	3640	4250	4860	5470	6010	6550	7095	7365	7635	7905	8175	8440	8700	8965	9225
30 km/h	2790	3340	3890	4445	4995	5545	6095	6215	6340	6460	6585	6825	7070		
40 km/h		3190	3725	4255	4770	5290	5805	5920	6040	6155	6270	6505	6735		
40 km/h Dual	2340	2800	3260	3725	4185	4645	5105	5210	5310	5415	5515	5720	5925		
50 km/h		3060	3570	4080	4575	5070	5565	5675	5790	5900	6010	6235	6455		
65 km/h			3350	3840	4325	4815	5300	5405	5515	5620	5725	5940	6150		

Ø inches	Description	CAI	e mm	D mm	R' mm	RC mm	Recommended Rim	Acceptable Rim	Tube (Code)	75% internal volume (litres)	Tread depth (mm)				
38	650/85R38 173A8/173B TL	118628	686	2063	924	6092	DW23B (A)	DW20B (A) MW23B (A)	804	860	64				
Bar	0.4	0.6	0.8	1	1.2	1.4	1.6	1.7	1.8	1.9	2	2.2	2.4	2.6	2.8
Psi	6	9	12	15	17	20	23	25	26	28	29	32	35	38	41
10 km/h	3750	4640	5530	6420	6780	7140	7500	7690	7875	8065	8250	8625	9000	9375	9750
10 km/h Cyc Dual				6400	6760	7120	7480	7665	7855	8040	8230	8605	8975	9350	9725
30 km/h	2700	3445	4195	4940	5245	5545	5850	5990	6125	6265	6405	6680	6955		
40 km/h		3000	3820	4640	4910	5180	5450	5580	5715	5845	5975	6240	6500		
40 km/h Dual	2200	2830	3455	4085	4320	4560	4795	4910	5025	5140	5260	5490	5720		
50 km/h		3000	3820	4640	4910	5180	5450	5580	5715	5845	5975	6240	6500		

Ø inches	Description	CAI	e mm	D mm	R' mm	RC mm	Recommended Rim	Acceptable Rim	Tube (Code)	75% internal volume (litres)	Tread depth (mm)
38	800/70R38 173D TL	887730	809	2066	899	6093	DW25B (A)	MW25B (A) DW27B (A)		1071	61
Bar	0.4	0.6	0.8	1	1.2	1.4	1.6	1.7	1.8	1.9	2
Psi	6	9	12	15	17	20	23	25	26	28	29
10 km/h	4400	5115	5825	6540	7255	7965	8680	9035	9395	9750	
10 km/h Cyc Dual				5260	6155	7045	7940	8390	8835	9280	9725
30 km/h	3375	4060	4740	5425	6110	6790	7475				
40 km/h		3860	4510	5165	5815	6470	7120				
40 km/h Dual	2825	3400	3970	4545	5115	5690	6260				
50 km/h		3700	4325	4950	5575	6200	6825				
65 km/h			4115	4710	5305	5905	6500				

* Refer to the notes at the end of the tables of this range

MICHELIN MACHXBIB

Tire specifications and pressure table (bar & psi). Load per tire in kg*

Ø inches	Description	CAI	e mm	D mm	R' mm	RC mm	Recommended Rim	Acceptable Rim	Tube (Code)	75% internal volume (litres)	Tread depth (mm)
42	900/50R42 168D TL	832458	853	1970	870	5826	DW27B (A)	DW28B (A) DW30B (A)		923	55
Bar	0.4	0.6	0.8	1	1.2	1.4	1.6	1.7	1.8	1.9	
Psi	6	9	12	15	17	20	23	25	26	28	
10 km/h	3825	4575	5195	5810	6430	7045	7665	7910	8155	8400	
30 km/h	2930	3510	4095	4680	5270	5855	6440				
40 km/h		3340	3900	4455	5015	5570	6130				
40 km/h Dual	2455	2940	3430	3925	4415	4910	5400				
50 km/h		3200	3735	4270	4810	5345	5880				
65 km/h			3550	4090	4595	5095	5600				

Ø inches	Description	CAI	e mm	D mm	R' mm	RC mm	Recommended Rim	Acceptable Rim	Tube (Code)	75% internal volume (litres)	Tread depth (mm)				
42	710/70R42 173D TL	790388	721	2088	932	6195	DW23B (A)	MW23B (A) DW25B (A) MW25B (A)	802	872	64				
Bar	0.4	0.6	0.8	1	1.2	1.4	1.6	1.7	1.8	1.9	2	2.2	2.4	2.6	2.8
Psi	6	9	12	15	17	20	23	25	26	28	29	32	35	38	41
10 km/h	3750	4375	5000	5625	6210	6795	7380	7675	7965	8260	8550	8850	9150	9450	9750
10 km/h Cyc Dual				4390	5190	5985	6785	7185	7580	7980	8380	8715	9050	9390	9725
30 km/h	2875	3470	4065	4660	5250	5845	6440	6570	6700	6830	6960	7215	7475		
40 km/h		3285	3835	4380	4965	5545	6130	6255	6380	6500	6625	6875	7120		
40 km/h Dual	2410	2910	3405	3905	4405	4900	5400	5510	5615	5725	5835	6050	6265		
50 km/h		3150	3675	4200	4760	5320	5880	6000	6115	6235	6355	6590	6825		
65 km/h				4000	4535	5065	5600	5715	5825	5940	6050	6275	6500		

Ø inches	Description	CAI	e mm	D mm	R' mm	RC mm	Recommended Rim	Acceptable Rim	Tube (Code)	75% internal volume (litres)	Tread depth (mm)				
42	710/75R42 175D/171E TL	015540	693	2158	968	6408	DW23B (A)	DW25B (A)	802	867	61				
Bar	0.4	0.6	0.8	1	1.2	1.4	1.6	1.7	1.8	1.9	2	2.2	2.4	2.6	2.8
Psi	6	9	12	15	17	20	23	25	26	28	29	32	35	38	41
10 km/h	3975	4775	5575	6375	7050	7725	8400	8740	9075	9415	9750	10125	10500	10875	11250
30 km/h	3050	3690	4335	4975	5615	6260	6900	7030	7160	7290	7420	7675	7935		
40 km/h		3560	4160	4765	5365	5970	6570	6695	6815	6940	7065	7310	7555		
40 km/h Dual	2555	3095	3630	4170	4705	5245	5780	5890	6000	6105	6215	6435	6650		
50 km/h		3415	3990	4570	5145	5725	6300	6420	6535	6655	6775	7010	7245		
65 km/h			3750	4315	4875	5440	6000	6115	6225	6340	6450	6675	6900		
70 km/h			3415	3925	4440	4950	5460	5545	5635	5720	5805	5980	6150		

* Refer to the notes at the end of the tables of this range

MICHELIN MACHXBIB

Tire specifications and pressure table (bar & psi). Load per tire in kg*

Ø inches	Description	CAI	e mm	D mm	R' mm	RC mm	Recommended Rim	Acceptable Rim	Tube (Code)	75% internal volume (litres)	Tread depth (mm)
46	620/70R46 162D TL NEW	131721	636	2042		6055	DW20B (A)	DW18L TW20B	834	698	
Bar	0.4 0.6 0.8	1 1.2 1.4	1.6 1.7 1.8 1.9								
Psi	6 9 12	15 17 20 23 25 26 28									
10 km/h	3180	3705	4235	4760	5285	5815	6340	6600	6865	7125	
30 km/h	2440	2945	3450	3955	4460	4960	5465				
40 km/h		2820	3300	3775	4250	4725	5200				
40 km/h Dual	2045	2465	2890	3310	3730	4155	4575				
50 km/h		2705	3165	3620	4075	4535	4990				
65 km/h			3000	3440	3875	4315	4750				

Ø inches	Description	CAI	e mm	D mm	R' mm	RC mm	Recommended Rim	Acceptable Rim	Tube (Code)	75% internal volume (litres)	Tread depth (mm)
46	620/70R46 162A8/162B TL XM28	122723	621	2061	926	6122	DW20B (A)		834	698	57
Bar	0.4 0.6 0.8	1 1.2 1.4	1.6 1.7 1.8 1.9								
Psi	6 9 12	15 17 20 23 25 26 28									
10 km/h	3060	4200	4650	5100	5550	6005	6455	6680	6905	7130	
30 km/h	2390	3300	3655	4010	4370	4725	5080				
40 km/h		3090	3420	3755	4085	4420	4750				
40 km/h Dual	1865	2720	3010	3305	3595	3890	4180				
50 km/h		3090	3420	3755	4085	4420	4750				

***IMPORTANT:**

The inflation pressure must always be appropriate for the load per tire, the speed of travel and the work to be done. Our recommendations above are provided subject to changes made after the date of publication of these tables (July 2020). Technical data is subject to change without prior notice.

- For plowing and other field applications subject to high torque, use the 30 km/h line.
- When using single tire configuration:
 - add 0.4 bar for use on slopes of more than 20%
 - add 0.4 bar for intensive road use exceeding 50% of time on road
- 10 km/h LT (Low Torque) (max speed 10 km/h).

TRACTORS

LOW & MEDIUM POWER



MICHELIN XEOBIB

EVERY DAY
ON ALL SURFACES
AT LESS THAN 1 BAR



FOR TRACTORS UP TO 220 HP

(for high load / torque, use MICHELIN MACHXBIB / AXIOBIB / AXIOBIB 2)



VERY HIGH FLEXION STANDARD (VF)



YIELDS

- Potential increase in yields of **up to 4% year**⁽¹⁾
- Excellent **SERVICE LIFE**



FUEL SAVINGS

- Supports fuel saving in field operations



COMFORT

- Absorbs shocks & surface irregularities

(1) Harper Adams University 2014/2016

SIZES

VF 480/60R28 134D TL

VF 520/60R28 138D TL

VF 600/60R28 146D TL

VF 600/60R30 147D TL

VF 600/60R34 149D TL

VF 600/60R38 151D TL

VF 650/60R38 155D TL

VF 710/60R38 160D TL

VF 650/60R42 157D TL

VF 710/60R42 161D TL

MICHELIN XEOBIB

Tire specifications and pressure table (bar & psi). Load per tire in kg*

Ø inches	Description	CAI	e mm	D mm	R' mm	RC mm	Recommended Rim	Acceptable Rim	Tube (Code)	75% internal volume (litres)	Tread depth (mm)
28	VF 480/60R28 134D TL	312875	488	1298	567	3831	DW16L	W16L	821	218	45
Bar	0.4	0.5	0.6	0.7	0.8	0.9	1	1.8			
Psi	6	7	9	10	12	13	15	26			
10 km/h	1450	1605	1760	1900	2035	2185	2330				
10 km/h Load Fr								3000			
30 km/h	1345	1490	1630	1760	1885	2025	2160				
65 km/h	1320	1460	1600	1725	1850	1985	2120				
65 km/h Dual	1160	1285	1410	1520	1630	1750	1865				

Ø inches	Description	CAI	e mm	D mm	R' mm	RC mm	Recommended Rim	Acceptable Rim	Tube (Code)	75% internal volume (litres)	Tread depth (mm)
28	VF 520/60R28 138D TL	510495	534	1338	579	3942	DW18L	W18L	822	260	46
Bar	0.4	0.5	0.6	0.7	0.8	0.9	1	1.8			
Psi	6	7	9	10	12	13	15	26			
10 km/h	1650	1815	1980	2125	2265	2430	2595				
10 km/h Load Fr								3350			
30 km/h	1530	1685	1835	1970	2100	2255	2405				
65 km/h	1500	1650	1800	1930	2060	2210	2360				
65 km/h Dual	1320	1455	1585	1700	1815	1945	2075				

Ø inches	Description	CAI	e mm	D mm	R' mm	RC mm	Recommended Rim	Acceptable Rim	Tube (Code)	75% internal volume (litres)	Tread depth (mm)
28	VF 600/60R28 146D TL	665184	597	1429	610	4198	DW20B (A)		822	365	48
Bar	0.4	0.5	0.6	0.7	0.8	0.9	1	1.8			
Psi	6	7	9	10	12	13	15	26			
10 km/h	2035	2250	2465	2690	2915	3110	3300				
10 km/h Load Fr								4250			
30 km/h	1885	2085	2285	2495	2705	2885	3060				
65 km/h	1850	2045	2240	2445	2650	2825	3000				
65 km/h Dual	1630	1800	1970	2150	2330	2485	2640				

Ø inches	Description	CAI	e mm	D mm	R' mm	RC mm	Recommended Rim	Acceptable Rim	Tube (Code)	75% internal volume (litres)	Tread depth (mm)
30	VF 600/60R30 147D TL	065253	603	1493	633	4379	DW20B (A)		757	383	50
Bar	0.4	0.5	0.6	0.7	0.8	0.9	1	1.8			
Psi	6	7	9	10	12	13	15	26			
10 km/h	2145	2340	2530	2765	3000	3195	3385				
10 km/h Load Fr								4375			
30 km/h	1990	2170	2345	2565	2780	2960	3135				
65 km/h	1950	2125	2300	2515	2725	2900	3075				
65 km/h Dual	1715	1870	2025	2215	2400	2555	2705				

* Refer to the notes at the end of the tables of this range

MICHELIN XEOBIB

Tire specifications and pressure table (bar & psi). Load per tire in kg*

Ø inches	Description	CAI	e mm	D mm	R' mm	RC mm	Recommended Rim	Acceptable Rim	Tube (Code)	75% internal volume (litres)	Tread depth (mm)
34	VF 600/60R34 149D TL	664777	595	1595	690	4699	DW20B (A)		823	416	48
Bar	0.4	0.5	0.6	0.7	0.8	0.9	1	1.8			
Psi	6	7	9	10	12	13	15	26			
10 km/h	2265	2470	2675	2935	3190	3385	3575				
10 km/h Load Fr							4550				
30 km/h	2100	2290	2480	2720	2960	3140	3315				
65 km/h	2060	2245	2430	2665	2900	3075	3250				
65 km/h Dual	1815	1980	2140	2345	2550	2705	2860				

Ø inches	Description	CAI	e mm	D mm	R' mm	RC mm	Recommended Rim	Acceptable Rim	Tube (Code)	75% internal volume (litres)	Tread depth (mm)
38	VF 600/60R38 151D TL	349257	549	1698	749	5023	DW20B (A)	MW20B (A)	824	452	52
Bar	0.4	0.5	0.6	0.7	0.8	0.9	1				
Psi	6	7	9	10	12	13	15				
10 km/h	2400	2620	2835	3070	3300	3550	3795				
30 km/h	2225	2425	2625	2845	3060	3290	3520				
65 km/h	2180	2380	2575	2790	3000	3225	3450				
65 km/h Dual	1920	2095	2265	2455	2640	2840	3035				

Ø inches	Description	CAI	e mm	D mm	R' mm	RC mm	Recommended Rim	Acceptable Rim	Tube (Code)	75% internal volume (litres)	Tread depth (mm)
38	VF 650/60R38 155D TL	454365	677	1735	749	5108	DW23B (A)	MW23B (A)	825	539	52
Bar	0.4	0.5	0.6	0.7	0.8	0.9	1				
Psi	6	7	9	10	12	13	15				
10 km/h	2675	2935	3190	3495	3795	4030	4265				
30 km/h	2480	2720	2960	3240	3520	3740	3955				
65 km/h	2430	2665	2900	3175	3450	3665	3875				
65 km/h Dual	2140	2345	2550	2795	3035	3225	3410				

Ø inches	Description	CAI	e mm	D mm	R' mm	RC mm	Recommended Rim	Acceptable Rim	Tube (Code)	75% internal volume (litres)	Tread depth (mm)
38	VF 710/60R38 160D TL	324138	712	1814	794	5356	DW25B (A)	MW25B (A)	825	665	54
Bar	0.4	0.5	0.6	0.7	0.8	0.9	1				
Psi	6	7	9	10	12	13	15				
10 km/h	3080	3385	3685	3975	4265	4610	4950				
30 km/h	2855	3135	3415	3685	3955	4275	4590				
65 km/h	2800	3075	3350	3615	3875	4190	4500				
65 km/h Dual	2465	2710	2950	3180	3410	3685	3960				

* Refer to the notes at the end of the tables of this range

MICHELIN XEOBIB

Tire specifications and pressure table (bar & psi). Load per tire in kg*

Ø inches	Description	CAI	e mm	D mm	R' mm	RC mm	Recommended Rim	Acceptable Rim	Tube (Code)	75% internal volume (litres)	Tread depth (mm)
42	VF 650/60R42 157D TL	220583	660	1840	810	5441	DW23B (A)	DW20B (A)	802	645	58
Bar	0.4	0.5	0.6	0.7	0.8	0.9	1				
Psi	6	7	9	10	12	13	15				
10 km/h	2835	3110	3385	3645	3905	4225	4540				
30 km/h	2625	2880	3135	3380	3620	3915	4210				
65 km/h	2575	2825	3075	3315	3550	3840	4125				
65 km/h Dual	2265	2485	2705	2915	3125	3380	3630				

Ø inches	Description	CAI	e mm	D mm	R' mm	RC mm	Recommended Rim	Acceptable Rim	Tube (Code)	75% internal volume (litres)	Tread depth (mm)
42	VF 710/60R42 161D TL	144294	716	1920	843	5675	DW25B (A)	MW25B (A)	802	713	57
Bar	0.4	0.5	0.6	0.7	0.8	0.9	1				
Psi	6	7	9	10	12	13	15				
10 km/h	3190	3495	3795	4170	4540	4815	5090				
30 km/h	2960	3240	3520	3865	4210	4465	4720				
65 km/h	2900	3175	3450	3790	4125	4375	4625				
65 km/h Dual	2550	2795	3035	3335	3630	3850	4070				

***IMPORTANT:**

The inflation pressure must always be appropriate for the load per tire, the speed of travel and the work to be done. Our recommendations above are provided subject to changes made after the date of publication of these tables (July 2020). Technical data is subject to change without prior notice.

- When using single tire configuration:
 - add 0.4 bar for use on slopes of more than 20%
 - add 0.4 bar for intense road use exceeding 50% of time on road
- 10 km/h Fr Loader: application with front-end loader at max. speed of 10 km/h.

TRACTORS

LOW & MEDIUM POWER



MICHELIN MULTIBIB

EXCELLENT LONGEVITY
FOR INCREASED MILEAGE



FOR TRACTORS UP TO 220 HP

(for high load / torque, use MICHELIN MACHXBIB / AXIOBIB / AXIOBIB 2)



VERSATILITY

- Great performance in the field & on the road



PRODUCTIVITY

- High traction to save time & fuel
- Soil protection
- Capable of speeds of up to 65 km/h⁽¹⁾



SERVICE LIFE

- Deepest tread depth vs 4 main competitors⁽²⁾



COMFORT

- Excellent road handling
- Increased ride comfort

(1) When authorised by the laws in force in the country

(2) For 650/65 R42 size

SIZES

320/65R16 107D TL

320/65R18 109A8/106B TL

340/65R18 113A8/110B TL

420/65R20 125A8/125B TL

440/65R20 128D TL

420/65R24 126D TL

420/65R24 126A8/126B TL

440/65R24 128D TL

480/65R24 133D TL

540/65R24 140D TL

420/65R28 135D TL

440/65R28 131D TL

480/65R28 136D TL

540/65R28 142D TL

540/65R30 143D TL

540/65R34 145D TL

540/65R34 152D TL

600/65R34 151D TL

540/65R38 147D TL

600/65R38 153D TL

650/65R38 157D TL

650/65R42 158D TL

MICHELIN MULTIBIB

Tire specifications and pressure table (bar & psi). Load per tire in kg*

Ø inches	Description	CAI	e mm	D mm	R' mm	RC mm	Recommended Rim	Acceptable Rim	Tube (Code)	75% internal volume (litres)	Tread depth (mm)
16	320/65R16 107D TL	494658	300	827	368	2452	W10L	W9		65	29
Bar	0.4	0.5	0.6	0.8	1	1.2	1.4	1.6	1.8	1.9	
Psi	6	7	9	12	15	17	20	23	26	28	
10 km/h	530	580	630	760	885	1015	1140	1270	1395	1460	
30 km/h	520	570	620	720	820	920	1025	1125			
40 km/h		530	580	680	775	875	975	1070			
50 km/h		510	555	650	745	840	935	1025			
65 km/h		490	535	625	710	800	890	975			

Ø inches	Description	CAI	e mm	D mm	R' mm	RC mm	Recommended Rim	Acceptable Rim	Tube (Code)	75% internal volume (litres)	Tread depth (mm)
18	320/65R18 109A8/106B TL <i>XM108</i>	123898	309	875	389	2594	W9	W10	444	64	28
Bar	0.4	0.5	0.6	0.8	1	1.2	1.4	1.6	1.7	1.8	1.9
Psi	6	7	9	12	15	17	20	23	25	26	28
10 km/h	400	535	670	805	940	1075	1210	1345	1415	1480	1550
30 km/h	390	500	610	710	805	905	1000	1100			
40 km/h		460	570	665	755	850	940	1030			
50 km/h		430	520	605	690	780	865	950			

Ø inches	Description	CAI	e mm	D mm	R' mm	RC mm	Recommended Rim	Acceptable Rim	Tube (Code)	75% internal volume (litres)	Tread depth (mm)
18	340/65R18 113A8/110B TL <i>XM108</i>	123888	319	911	407	2719	W9	W10 W11	444	77	29
Bar	0.4	0.5	0.6	0.8	1	1.2	1.4	1.6	1.7	1.8	1.9
Psi	6	7	9	12	15	17	20	23	25	26	28
10 km/h	450	600	750	900	1050	1200	1355	1505	1580	1655	1730
30 km/h	440	560	680	790	900	1010	1120	1230			
40 km/h		520	630	735	840	945	1050	1150			
50 km/h		480	580	675	770	870	965	1060			

Ø inches	Description	CAI	e mm	D mm	R' mm	RC mm	Recommended Rim	Acceptable Rim	Tube (Code)	75% internal volume (litres)	Tread depth (mm)
20	420/65R20 125A8/125B TL <i>XM108</i>	122702	396	1064	461	3135	W11	W10 W12	664	140	36
Bar	0.4	0.5	0.6	0.8	1	1.2	1.4	1.6	1.7	1.8	
Psi	6	7	9	12	15	17	20	23	25	26	
10 km/h	970	1140	1310	1525	1735	1950	2160	2375	2480		
30 km/h	770	925	1080	1255	1425	1600	1770				
40 km/h		830	1010	1170	1330	1490	1650				
50 km/h		830	1010	1115	1225	1330	1435	1545	1595	1650	

* Refer to the notes at the end of the tables of this range

MICHELIN MULTIBIB

Tire specifications and pressure table (bar & psi). Load per tire in kg*

Ø inches	Description	CAI	e mm	D mm	R' mm	RC mm	Recommended Rim	Acceptable Rim	Tube (Code)	75% internal volume (litres)	Tread depth (mm)
20	440/65R20 128D TL	675464	445	1090	475	3260	W14L	W13 W15L	664	157	44
Bar	0.4	0.5	0.6	0.8	1	1.2	1.4	1.6	1.8	1.9	2
Psi	6	7	9	12	15	17	20	23	26	28	29
10 km/h	1200	1295	1390	1570	1750	1930	2125	2315	2510	2605	2700
30 km/h	920	1020	1120	1305	1485	1670	1870	2070			
40 km/h			1070	1245	1415	1590	1780	1970			
40 km/h Dual	770	855	940	1095	1245	1400	1570	1735			
50 km/h			1025	1165	1310	1450	1670	1890			
65 km/h			975	1135	1290	1450	1625	1800			

Ø inches	Description	CAI	e mm	D mm	R' mm	RC mm	Recommended Rim	Acceptable Rim	Tube (Code)	75% internal volume (litres)	Tread depth (mm)
24	420/65R24 126D TL	171560	392	1156	508	3416	W12	11 W11 DW12	700	159	38
Bar	0.4	0.5	0.6	0.8	1	1.2	1.4	1.6	1.8	1.9	2
Psi	6	7	9	12	15	17	20	23	26	28	29
10 km/h	1200	1315	1425	1575	1725	1875	2025	2175	2365	2455	2550
30 km/h	920	1010	1095	1290	1480	1670	1815	1955			
40 km/h			1040	1225	1410	1590	1725	1860			
50 km/h			1000	1175	1350	1525	1655	1785			
65 km/h			950	1120	1285	1450	1575	1700			

Ø inches	Description	CAI	e mm	D mm	R' mm	RC mm	Recommended Rim	Acceptable Rim	Tube (Code)	75% internal volume (litres)	Tread depth (mm)
24	420/65R24 126A8/126B TL <i>XM108</i>	122712	395	1160	507	3425	W11	W10 W12	700	150	37
Bar	0.4	0.5	0.6	0.8	1	1.2	1.4	1.6	1.7	1.8	
Psi	6	7	9	12	15	17	20	23	25	26	
10 km/h	990	1170	1350	1570	1785	2005	2225	2440	2550		
30 km/h	790	950	1110	1290	1465	1645	1820				
40 km/h		850	1040	1205	1370	1535	1700				
50 km/h		850	1040	1150	1260	1370	1480	1590	1645	1700	

* Refer to the notes at the end of the tables of this range

MICHELIN MULTIBIB

Tire specifications and pressure table (bar & psi). Load per tire in kg*

Ø inches	Description	CAI	e mm	D mm	R' mm	RC mm	Recommended Rim	Acceptable Rim	Tube (Code)	75% internal volume (litres)	Tread depth (mm)
24	440/65R24 128D TL	426389	439	1187	529	3519	DW14L	DW13 W13 W14L DW15L W15L	703	178	44
Bar	0.4	0.5	0.6	0.8	1	1.2	1.4	1.6	1.8	1.9	2
Psi	6	7	9	12	15	17	20	23	26	28	29
10 km/h	1285	1370	1450	1655	1855	2060	2225	2395	2560	2640	2725
30 km/h	980	1080	1180	1380	1580	1780	1925	2070			
40 km/h			1130	1320	1510	1700	1835	1970			
40 km/h Dual	820	910	995	1160	1330	1495	1615	1735			
50 km/h			1080	1265	1445	1630	1760	1890			
65 km/h			1030	1205	1375	1550	1675	1800			

Ø inches	Description	CAI	e mm	D mm	R' mm	RC mm	Recommended Rim	Acceptable Rim	Tube (Code)	75% internal volume (litres)	Tread depth (mm)
24	480/65R24 133D TL	531721	483	1240	546	3667	DW15L	DW14L W14L W15L	710	218	46
Bar	0.4	0.5	0.6	0.8	1	1.2	1.4	1.6	1.8	1.9	2
Psi	6	7	9	12	15	17	20	23	26	28	29
10 km/h	1450	1575	1700	1920	2140	2360	2560	2755	2955	3050	3150
30 km/h	1120	1240	1360	1575	1795	2010	2190	2370			
40 km/h			1290	1500	1710	1920	2090	2260			
40 km/h Dual	940	1040	1135	1320	1505	1690	1840	1990			
50 km/h			1240	1440	1640	1840	2000	2160			
65 km/h			1180	1370	1560	1750	1905	2060			

Ø inches	Description	CAI	e mm	D mm	R' mm	RC mm	Recommended Rim	Acceptable Rim	Tube (Code)	75% internal volume (litres)	Tread depth (mm)
24	540/65R24 140D TL	097057	532	1312	573	3873	DW16L	W16L DW18L W18L	710	287	48
Bar	0.4	0.5	0.6	0.8	1	1.2	1.4	1.6	1.8	1.9	2
Psi	6	7	9	12	15	17	20	23	26	28	29
10 km/h	1750	1875	2000	2265	2535	2800	3040	3275	3515	3630	3750
30 km/h	1360	1485	1610	1885	2165	2440	2660	2880			
40 km/h			1530	1795	2055	2320	2530	2740			
40 km/h Dual	1140	1245	1345	1575	1810	2040	2225	2410			
50 km/h			1470	1725	1975	2230	2430	2630			

* Refer to the notes at the end of the tables of this range

MICHELIN MULTIBIB

Tire specifications and pressure table (bar & psi). Load per tire in kg*

65 km/h 1400 1640 1880 2120 2310 2500

Ø inches	Description	CAI	e mm	D mm	R' mm	RC mm	Recommended Rim	Acceptable Rim	Tube (Code)	75% internal volume (litres)	Tread depth (mm)				
28	420/65R28 135D TL	778211	390	1238	558	3680	W11	W12	732	177	44				
Bar	0.4	0.5	0.6	0.8	1	1.2	1.4	1.6	1.8	1.9	2	2.2	2.4	2.7	2.8
Psi	6	7	9	12	15	17	20	23	26	28	29	32	35	39	41
10 km/h	1275	1410	1545	1710	1875	2040	2185	2325	2495	2580	2665	2830	3000	3205	3270
30 km/h	980	1085	1185	1355	1535	1715	1890	2070	2180	2235	2290	2395	2505		
40 km/h			1130	1290	1460	1630	1800	1970	2075	2125	2180	2280	2385		
40 km/h Dual	820	910	995	1160	1330	1495	1615	1735	1825	1870	1920	2010	2100	2230	2275
50 km/h			1030	1240	1405	1565	1725	1890	1990	2040	2090	2190	2290		
65 km/h			1030	1180	1335	1490	1645	1800	1895	1945	1990	2085	2180		

Ø inches	Description	CAI	e mm	D mm	R' mm	RC mm	Recommended Rim	Acceptable Rim	Tube (Code)	75% internal volume (litres)	Tread depth (mm)
28	440/65R28 131D TL	386212	437	1291	579	3833	DW14L	W13 W14L DW15L W15L	821	198	43
Bar	0.4	0.5	0.6	0.8	1	1.2	1.4	1.6	1.8	1.9	2
Psi	6	7	9	12	15	17	20	23	26	28	29
10 km/h	1360	1480	1600	1795	1985	2180	2360	2540	2720	2810	2900
30 km/h	1060	1155	1250	1465	1685	1900	2070	2240			
40 km/h			1190	1395	1605	1810	1975	2140			
40 km/h Dual	890	970	1045	1230	1410	1595	1740	1885			
50 km/h			1140	1335	1535	1730	1890	2050			
65 km/h			1090	1275	1465	1650	1800	1950			

Ø inches	Description	CAI	e mm	D mm	R' mm	RC mm	Recommended Rim	Acceptable Rim	Tube (Code)	75% internal volume (litres)	Tread depth (mm)
28	480/65R28 136D TL	897574	476	1339	596	3970	DW15L	DW14L W14L W15L	822	242	45
Bar	0.4	0.5	0.6	0.8	1	1.2	1.4	1.6	1.8	1.9	2
Psi	6	7	9	12	15	17	20	23	26	28	29
10 km/h	1550	1675	1800	2035	2265	2500	2715	2925	3140	3245	3350
30 km/h	1180	1310	1440	1690	1940	2190	2385	2580			
40 km/h			1370	1605	1845	2080	2265	2450			
40 km/h Dual	990	1100	1205	1415	1620	1830	1995	2155			
50 km/h			1310	1540	1770	2000	2175	2350			
65 km/h			1250	1465	1685	1900	2070	2240			

* Refer to the notes at the end of the tables of this range

MICHELIN MULTIBIB

Tire specifications and pressure table (bar & psi). Load per tire in kg*

Ø inches	Description	CAI	e mm	D mm	R' mm	RC mm	Recommended Rim	Acceptable Rim	Tube (Code)	75% internal volume (litres)	Tread depth (mm)
28	540/65R28 142D TL	792274	529	1427	630	4223	DW16L	W16L DW18L W18L	822	318	48
Bar	0.4	0.5	0.6	0.8	1	1.2	1.4	1.6	1.8	1.9	2
Psi	6	7	9	12	15	17	20	23	26	28	29
10 km/h	1900	2040	2180	2455	2725	3000	3250	3500	3750	3875	4000
30 km/h	1440	1585	1730	2015	2295	2580	2815	3050			
40 km/h			1640	1910	2180	2450	2675	2900			
40 km/h Dual	1205	1325	1445	1680	1920	2155	2355	2550			
50 km/h			1580	1835	2095	2350	2565	2780			
65 km/h			1500	1745	1995	2240	2445	2650			

Ø inches	Description	CAI	e mm	D mm	R' mm	RC mm	Recommended Rim	Acceptable Rim	Tube (Code)	75% internal volume (litres)	Tread depth (mm)
30	540/65R30 143D TL	223153	527	1472	648	4353	DW16L	W16L DW18L W18L	754	333	48
Bar	0.4	0.5	0.6	0.8	1	1.2	1.4	1.6	1.8	1.9	2
Psi	6	7	9	12	15	17	20	23	26	28	29
10 km/h	1950	2095	2240	2520	2795	3075	3340	3600	3865	3995	4125
30 km/h	1480	1630	1780	2070	2360	2650	2890	3130			
40 km/h			1700	1975	2245	2520	2750	2980			
40 km/h Dual	1240	1370	1495	1735	1980	2220	2420	2620			
50 km/h			1630	1895	2155	2420	2640	2860			
65 km/h			1550	1800	2050	2300	2515	2725			

Ø inches	Description	CAI	e mm	D mm	R' mm	RC mm	Recommended Rim	Acceptable Rim	Tube (Code)	75% internal volume (litres)	Tread depth (mm)
34	540/65R34 145D TL	712064	530	1574	693	4655	DW16L	W16L DW18L W18L	704	364	48
Bar	0.4	0.5	0.6	0.8	1	1.2	1.4	1.6	1.8	1.9	2
Psi	6	7	9	12	15	17	20	23	26	28	29
10 km/h	2060	2210	2360	2655	2955	3250	3530	3815	4095	4235	4375
30 km/h	1560	1730	1900	2225	2555	2880	3110	3340			
40 km/h			1810	2120	2430	2740	2960	3180			
40 km/h Dual	1310	1455	1595	1865	2140	2410	2605	2800			
50 km/h			1730	2030	2330	2630	2840	3050			
65 km/h			1650	1935	2215	2500	2700	2900			

* Refer to the notes at the end of the tables of this range

MICHELIN MULTIBIB

Tire specifications and pressure table (bar & psi). Load per tire in kg*

Ø inches	Description	CAI	e mm	D mm	R' mm	RC mm	Recommended Rim	Acceptable Rim	Tube (Code)	75% internal volume (litres)	Tread depth (mm)				
34	540/65R34 152D TL	214036	530	1590	709	4716	DW16L	W16L DW18L W18L	704	364	48				
Bar	0.4	0.5	0.6	0.8	1	1.2	1.4	1.6	1.8	1.9	2	2.2	2.4	2.7	2.8
Psi	6	7	9	12	15	17	20	23	26	28	29	32	35	39	41
10 km/h	2060	2210	2360	2655	2955	3250	3530	3815	4095	4235	4375	4625	4875	5215	5325
30 km/h	1560	1730	1900	2225	2555	2880	3110	3340	3525	3620	3710	3895	4080		
40 km/h			1810	2120	2430	2740	2960	3180	3360	3445	3535	3715	3890		
40 km/h Dual	1310	1455	1595	1865	2140	2410	2605	2800	2955	3035	3110	3265	3420		
50 km/h			1730	2030	2330	2630	2840	3050	3220	3305	3390	3560	3730		
65 km/h			1650	1935	2215	2500	2700	2900	3065	3145	3225	3390	3550		

Ø inches	Description	CAI	e mm	D mm	R' mm	RC mm	Recommended Rim	Acceptable Rim	Tube (Code)	75% internal volume (litres)	Tread depth (mm)
34	600/65R34 151D TL	557189	594	1654	732	4897	DW20B (A)	DW18L W18L	823	464	54
Bar	0.4	0.5	0.6	0.8	1	1.2	1.4	1.6	1.8	1.9	2
Psi	6	7	9	12	15	17	20	23	26	28	29
10 km/h	2430	2615	2800	3160	3515	3875	4195	4515	4830	4990	5150
30 km/h	1840	2040	2240	2605	2975	3340	3655	3970			
40 km/h			2140	2485	2835	3180	3480	3780			
40 km/h Dual	1540	1715	1885	2190	2495	2800	3065	3325			
50 km/h			2050	2385	2715	3050	3335	3620			
65 km/h			1950	2265	2585	2900	3175	3450			

Ø inches	Description	CAI	e mm	D mm	R' mm	RC mm	Recommended Rim	Acceptable Rim	Tube (Code)	75% internal volume (litres)	Tread depth (mm)
38	540/65R38 147D TL	114518	529	1675	745	4965	DW16L	W16L DW18L W18L	824	394	48
Bar	0.4	0.5	0.6	0.8	1	1.2	1.4	1.6	1.8	1.9	2
Psi	6	7	9	12	15	17	20	23	26	28	29
10 km/h	2180	2340	2500	2815	3135	3450	3745	4040	4330	4480	4625
30 km/h	1670	1840	2010	2325	2645	2960	3250	3540			
40 km/h			1920	2220	2520	2820	3095	3370			
40 km/h Dual	1400	1545	1690	1955	2215	2480	2725	2965			
50 km/h			1840	2125	2415	2700	2965	3230			
65 km/h			1750	2025	2300	2575	2825	3075			

* Refer to the notes at the end of the tables of this range

MICHELIN MULTIBIB

Tire specifications and pressure table (bar & psi). Load per tire in kg*

Ø inches	Description	CAI	e mm	D mm	R' mm	RC mm	Recommended Rim	Acceptable Rim	Tube (Code)	75% internal volume (litres)	Tread depth (mm)
38	600/65R38 153D TL	228045	595	1768	779	5229	DW20B (A)	DW18L W18L	825	500	53
Bar	0.4	0.5	0.6	0.8	1	1.2	1.4	1.6	1.8	1.9	2
Psi	6	7	9	12	15	17	20	23	26	28	29
10 km/h	2575	2775	2970	3355	3740	4125	4455	4790	5120	5285	5450
30 km/h	1960	2165	2370	2760	3150	3540	3870	4200			
40 km/h			2260	2630	3000	3370	3685	4000			
40 km/h Dual	1645	1820	1990	2315	2640	2965	3245	3520			
50 km/h			2160	2515	2875	3230	3530	3830			
65 km/h			2060	2400	2735	3075	3365	3650			

Ø inches	Description	CAI	e mm	D mm	R' mm	RC mm	Recommended Rim	Acceptable Rim	Tube (Code)	75% internal volume (litres)	Tread depth (mm)
38	650/65R38 157D TL	292904	646	1819	801	5380	DW20B (A)		825	602	56
Bar	0.4	0.5	0.6	0.8	1	1.2	1.4	1.6	1.8	1.9	2
Psi	6	7	9	12	15	17	20	23	26	28	29
10 km/h	2900	3125	3350	3775	4200	4625	5005	5390	5770	5960	6150
30 km/h	2190	2420	2650	3090	3530	3970	4355	4740			
40 km/h			2520	2940	3360	3780	4150	4520			
40 km/h Dual	1835	2030	2220	2590	2955	3325	3655	3980			
50 km/h			2420	2820	3220	3620	3975	4330			
65 km/h			2300	2685	3065	3450	3790	4125			

Ø inches	Description	CAI	e mm	D mm	R' mm	RC mm	Recommended Rim	Acceptable Rim	Tube (Code)	75% internal volume (litres)	Tread depth (mm)
42	650/65R42 158D TL	167733	638	1931	858	5722	DW20B (A)		802	647	57
Bar	0.4	0.5	0.6	0.8	1	1.2	1.4	1.6	1.8	1.9	2
Psi	6	7	9	12	15	17	20	23	26	28	29
10 km/h	3000	3225	3450	3885	4315	4750	5155	5565	5970	6170	6375
30 km/h	2300	2545	2790	3260	3730	4200	4545	4890			
40 km/h			2660	3105	3555	4000	4325	4650			
40 km/h Dual	1930	2135	2340	2735	3125	3520	3805	4090			
50 km/h			2550	2975	3405	3830	4145	4460			
65 km/h			2430	2835	3245	3650	3950	4250			

***IMPORTANT:**

The inflation pressure must always be appropriate for the load per tire, the speed of travel and the work to be done. Our recommendations above are provided subject to changes made after the date of publication of these tables (July 2020). Technical data is subject to change without prior notice.

- For plowing and other field applications subject to high torque, use the 30 km/h line.
- When using single tire configuration:
 - add 0.4 bar for use on slopes of more than 20%
 - add 0.4 bar for intensive road use exceeding 50% of time on road
- 10 km/h LT (Low Torque) (max speed 10 km/h).

TRACTORS

LOW & MEDIUM POWER



MICHELIN OMNIBIB

GREATER VERSATILITY
TO OPTIMIZE YOUR COSTS



FOR TRACTORS UP TO 220 HP

(for high load / torque, use MICHELIN MACHXBIB / AXIOBIB / AXIOBIB 2)



VERSATILITY

- Specially designed to withstand the stresses of work with front loaders
- Up to 14%⁽¹⁾ more **load capacity** versus equivalent standard radial sizes
- Excellent **stability & maneuverability** for work with livestock
- Super **traction** capacity



SERVICE LIFE

- Proven casing endurance
- Damage resistance

(1) Depending on tire sizes & compared with the equivalent size in MICHELIN AGRIBIB

SIZES

280/70R16 112D TL

280/70R20 116D TL

320/70R24 116D TL

360/70R24 122D TL

380/70R24 125D TL

420/70R24 130D TL

480/70R24 138D TL

380/70R28 127D TL

420/70R28 133D TL

480/70R28 140D TL

480/70R30 141D TL

480/70R34 143D TL

520/70R34 148D TL

480/70R38 145D TL

520/70R38 150D TL

580/70R38 155D TL

620/70R42 160D TL

MICHELIN OMNIBIB

Tire specifications and pressure table (bar & psi). Load per tire in kg*

Ø inches	Description	CAI	e mm	D mm	R' mm	RC mm	Recommended Rim		Acceptable Rim		Tube (Code)	75% internal volume (litres)	Tread depth (mm)		
16	280/70R16 112D TL	747196	276	805	360	2400	W9		W10L W8L W8		184	45	29		
Bar	0.4	0.5	0.6	0.8	1	1.2	1.4	1.6	1.8	1.9	2	2.2	2.4	2.7	2.8
Psi	6	7	9	12	15	17	20	23	26	28	29	32	35	39	41
10 km/h	580	625	665	755	840	930	1015	1100	1190	1230	1275	1375	1480	1630	1680
30 km/h	445	490	535	625	715	800	890	980	1060	1095	1135	1215	1290		
40 km/h			505	590	675	760	845	930	1005	1040	1080	1150	1225		
40 km/h Dual	375	410	445	520	595	670	745	820	885	920	950	1015	1080		
50 km/h			485	565	650	730	815	895	965	1000	1035	1105	1175		
65 km/h			460	540	615	695	770	850	920	950	985	1055	1120		

Ø inches	Description	CAI	e mm	D mm	R' mm	RC mm	Recommended Rim		Acceptable Rim		Tube (Code)	75% internal volume (litres)	Tread depth (mm)		
20	280/70R20 116D TL	263806	268	904	409	2690	W9		W8 W10		533	61	29		
Bar	0.4	0.5	0.6	0.8	1	1.2	1.4	1.6	1.8	1.9	2	2.2	2.4	2.7	2.8
Psi	6	7	9	12	15	17	20	23	26	28	29	32	35	39	41
10 km/h	640	690	740	835	935	1035	1130	1230	1325	1375	1425	1540	1650	1820	1875
30 km/h	490	540	590	690	795	895	995	1095	1180	1225	1270	1355	1440		
40 km/h			565	660	755	850	945	1040	1125	1165	1205	1290	1370		
50 km/h			540	630	725	815	910	1000	1080	1120	1160	1235	1315		
65 km/h			515	600	690	775	865	950	1025	1065	1100	1175	1250		

Ø inches	Description	CAI	e mm	D mm	R' mm	RC mm	Recommended Rim		Acceptable Rim		Tube (Code)	75% internal volume (litres)	Tread depth (mm)		
24	320/70R24 116D TL	415039	323	1101	497	3274	W10		W9 W11		692	94	40		
Bar	0.4	0.5	0.6	0.8	1	1.2	1.4	1.6	1.8	1.9	2				
Psi	6	7	9	12	15	17	20	23	26	28	29				
10 km/h	870	935	995	1125	1250	1375	1500	1630	1755	1815	1880				
30 km/h	670	735	800	925	1055	1185	1310	1440							
40 km/h			760	880	1005	1125	1250	1370							
40 km/h Dual	560	615	670	775	885	990	1100	1205							
50 km/h			720	840	955	1075	1190	1310							
65 km/h			690	800	915	1025	1140	1250							

* Refer to the notes at the end of the tables of this range

MICHELIN OMNIBIB

Tire specifications and pressure table (bar & psi). Load per tire in kg*

Ø inches	Description	CAI	e mm	D mm	R' mm	RC mm	Recommended Rim	Acceptable Rim	Tube (Code)	75% internal volume (litres)	Tread depth (mm)
24	360/70R24 122D TL	198698	373	1153	513	3418	W11	W10 W12L	692	137	43
Bar	0.4	0.5	0.6	0.8	1	1.2	1.4	1.6	1.8	1.9	2
Psi	6	7	9	12	15	17	20	23	26	28	29
10 km/h	1040	1115	1190	1345	1495	1645	1795	1950	2100	2175	2250
30 km/h	790	870	945	1105	1260	1415	1575	1730			
40 km/h			900	1050	1195	1345	1490	1640			
40 km/h Dual	665	730	795	925	1055	1185	1315	1445			
50 km/h			870	1010	1155	1295	1440	1580			
65 km/h			825	960	1095	1230	1365	1500			

Ø inches	Description	CAI	e mm	D mm	R' mm	RC mm	Recommended Rim	Acceptable Rim	Tube (Code)	75% internal volume (litres)	Tread depth (mm)
24	380/70R24 125D TL	085816	399	1188	528	3520	W12	W11 W13	700	161	45
Bar	0.4	0.5	0.6	0.8	1	1.2	1.4	1.6	1.8	1.9	2
Psi	6	7	9	12	15	17	20	23	26	28	29
10 km/h	1130	1215	1300	1470	1635	1805	1975	2145	2310	2395	2480
30 km/h	860	945	1035	1205	1380	1555	1725	1900			
40 km/h			990	1155	1320	1480	1645	1810			
40 km/h Dual	725	795	865	1010	1155	1300	1445	1590			
50 km/h			950	1105	1260	1420	1575	1730			
65 km/h			900	1050	1200	1350	1500	1650			

Ø inches	Description	CAI	e mm	D mm	R' mm	RC mm	Recommended Rim	Acceptable Rim	Tube (Code)	75% internal volume (litres)	Tread depth (mm)
24	420/70R24 130D TL	829095	436	1251	553	3702	W13	W12L DW14L W14L	703	203	46
Bar	0.4	0.5	0.6	0.8	1	1.2	1.4	1.6	1.8	1.9	2
Psi	6	7	9	12	15	17	20	23	26	28	29
10 km/h	1310	1405	1505	1695	1890	2080	2275	2465	2660	2755	2850
30 km/h	1010	1110	1205	1405	1600	1795	1995	2190			
40 km/h			1130	1320	1510	1700	1890	2080			
40 km/h Dual	845	920	995	1160	1330	1495	1665	1830			
50 km/h			1080	1265	1450	1630	1815	2000			
65 km/h			1030	1205	1380	1550	1725	1900			

* Refer to the notes at the end of the tables of this range

MICHELIN OMNIBIB

Tire specifications and pressure table (bar & psi). Load per tire in kg*

Ø inches	Description	CAI	e mm	D mm	R' mm	RC mm	Recommended Rim	Acceptable Rim	Tube (Code)	75% internal volume (litres)	Tread depth (mm)
24	480/70R24 138D TL	375821	494	1327	578	3916	DW15L	DW14L W14L W15L DW16L W16L	710	276	48
Bar	0.4	0.5	0.6	0.8	1	1.2	1.4	1.6	1.8	1.9	2
Psi	6	7	9	12	15	17	20	23	26	28	29
10 km/h	1590	1710	1835	2080	2320	2565	2810	3055	3295	3420	3540
30 km/h	1220	1345	1470	1715	1965	2215	2460	2710			
40 km/h			1410	1645	1880	2110	2345	2580			
40 km/h Dual	1020	1130	1240	1445	1655	1860	2070	2275			
50 km/h			1350	1575	1800	2030	2255	2480			
65 km/h			1285	1500	1715	1930	2145	2360			

Ø inches	Description	CAI	e mm	D mm	R' mm	RC mm	Recommended Rim	Acceptable Rim	Tube (Code)	75% internal volume (litres)	Tread depth (mm)
28	380/70R28 127D TL	118587	390	1294	580	3842	W12	W11 W13	732	179	45
Bar	0.4	0.5	0.6	0.8	1	1.2	1.4	1.6	1.8	1.9	2
Psi	6	7	9	12	15	17	20	23	26	28	29
10 km/h	1200	1290	1380	1560	1735	1915	2095	2275	2450	2540	2630
30 km/h	920	1010	1100	1285	1465	1645	1830	2010			
40 km/h			1040	1215	1390	1570	1745	1920			
40 km/h Dual	770	845	915	1070	1225	1375	1530	1685			
50 km/h			1000	1170	1335	1505	1670	1840			
65 km/h			950	1110	1270	1430	1590	1750			

Ø inches	Description	CAI	e mm	D mm	R' mm	RC mm	Recommended Rim	Acceptable Rim	Tube (Code)	75% internal volume (litres)	Tread depth (mm)
28	420/70R28 133D TL	532215	436	1354	602	4012	W13	W12 DW14L W14L	821	231	46
Bar	0.4	0.5	0.6	0.8	1	1.2	1.4	1.6	1.8	1.9	2
Psi	6	7	9	12	15	17	20	23	26	28	29
10 km/h	1390	1495	1605	1815	2030	2240	2455	2665	2880	2985	3090
30 km/h	1060	1170	1280	1495	1715	1935	2150	2370			
40 km/h			1230	1435	1640	1850	2055	2260			
40 km/h Dual	890	985	1080	1260	1440	1625	1805	1985			
50 km/h			1180	1375	1570	1770	1965	2160			
65 km/h			1120	1310	1495	1685	1870	2060			

* Refer to the notes at the end of the tables of this range

MICHELIN OMNIBIB

Tire specifications and pressure table (bar & psi). Load per tire in kg*

Ø inches	Description	CAI	e mm	D mm	R' mm	RC mm	Recommended Rim	Acceptable Rim	Tube (Code)	75% internal volume (litres)	Tread depth (mm)
28	480/70R28 140D TL	570026	500	1427	632	4217	DW15L	DW14L W14L W15L DW16L W16L	822	302	48
Bar	0.4	0.5	0.6	0.8	1	1.2	1.4	1.6	1.8	1.9	2
Psi	6	7	9	12	15	17	20	23	26	28	29
10 km/h	1730	1855	1985	2235	2490	2740	2995	3245	3500	3625	3750
30 km/h	1320	1450	1580	1840	2100	2360	2620	2880			
40 km/h			1490	1740	1990	2240	2490	2740			
40 km/h Dual	1110	1210	1310	1530	1750	1970	2190	2410			
50 km/h			1430	1670	1910	2150	2390	2630			
65 km/h			1360	1590	1815	2045	2270	2500			

Ø inches	Description	CAI	e mm	D mm	R' mm	RC mm	Recommended Rim	Acceptable Rim	Tube (Code)	75% internal volume (litres)	Tread depth (mm)
30	480/70R30 141D TL	599351	498	1482	656	4388	DW15L	DW14L W14L W15L DW16L W16L	754	317	48
Bar	0.4	0.5	0.6	0.8	1	1.2	1.4	1.6	1.8	1.9	2
Psi	6	7	9	12	15	17	20	23	26	28	29
10 km/h	1770	1900	2030	2295	2555	2815	3075	3340	3600	3730	3860
30 km/h	1360	1495	1625	1895	2160	2425	2695	2960			
40 km/h			1530	1790	2045	2305	2560	2820			
40 km/h Dual	1135	1245	1350	1575	1800	2030	2255	2480			
50 km/h			1470	1715	1960	2210	2455	2700			
65 km/h			1400	1635	1870	2105	2340	2575			

Ø inches	Description	CAI	e mm	D mm	R' mm	RC mm	Recommended Rim	Acceptable Rim	Tube (Code)	75% internal volume (litres)	Tread depth (mm)
34	480/70R34 143D TL	280033	497	1593	713	4728	DW15L	DW14L W14L W15L DW16L W16L	704	345	50
Bar	0.4	0.5	0.6	0.8	1	1.2	1.4	1.6	1.8	1.9	2
Psi	6	7	9	12	15	17	20	23	26	28	29
10 km/h	1880	2020	2155	2435	2710	2985	3260	3540	3815	3950	4090
30 km/h	1440	1580	1720	2005	2285	2565	2850	3130			
40 km/h			1640	1910	2175	2445	2710	2980			
40 km/h Dual	1205	1325	1445	1680	1915	2155	2390	2625			
50 km/h			1580	1835	2090	2350	2605	2860			
65 km/h			1500	1745	1990	2235	2480	2725			

* Refer to the notes at the end of the tables of this range

MICHELIN OMNIBIB

Tire specifications and pressure table (bar & psi). Load per tire in kg*

Ø inches	Description	CAI	e mm	D mm	R' mm	RC mm	Recommended Rim		Acceptable Rim	Tube (Code)	75% internal volume (litres)	Tread depth (mm)
34	520/70R34 148D TL	939411	535	1651	730	4887	DW16L		DW15L W15L W16L DW18L W18L	823	422	53
Bar	0.4	0.5	0.6	0.8	1	1.2	1.4	1.6	1.8	1.9	2	
Psi	6	7	9	12	15	17	20	23	26	28	29	
10 km/h	2100	2265	2430	2760	3085	3415	3745	4075	4400	4565	4730	
30 km/h	1610	1780	1945	2280	2615	2950	3285	3620				
40 km/h			1860	2180	2495	2815	3130	3450				
40 km/h Dual	1350	1495	1640	1920	2200	2475	2755	3035				
50 km/h			1790	2095	2400	2700	3005	3310				
65 km/h			1700	1990	2280	2570	2860	3150				

Ø inches	Description	CAI	e mm	D mm	R' mm	RC mm	Recommended Rim		Acceptable Rim	Tube (Code)	75% internal volume (litres)	Tread depth (mm)
38	480/70R38 145D TL	936570	498	1694	759	5030	DW15L		DW14L W14L W15L DW16L W16L	786	377	52
Bar	0.4	0.5	0.6	0.8	1	1.2	1.4	1.6	1.8	1.9	2	
Psi	6	7	9	12	15	17	20	23	26	28	29	
10 km/h	1980	2130	2275	2575	2870	3165	3460	3760	4055	4200	4350	
30 km/h	1520	1670	1825	2125	2430	2735	3035	3340				
40 km/h			1750	2035	2320	2610	2895	3180				
40 km/h Dual	1270	1405	1540	1790	2040	2295	2545	2795				
50 km/h			1680	1955	2230	2500	2775	3050				
65 km/h			1600	1860	2120	2380	2640	2900				

Ø inches	Description	CAI	e mm	D mm	R' mm	RC mm	Recommended Rim		Acceptable Rim	Tube (Code)	75% internal volume (litres)	Tread depth (mm)
38	520/70R38 150D TL	833744	539	1766	782	5229	DW16L		DW15L W15L W16L DW18L W18L	824	464	53
Bar	0.4	0.5	0.6	0.8	1	1.2	1.4	1.6	1.8	1.9	2	
Psi	6	7	9	12	15	17	20	23	26	28	29	
10 km/h	2250	2425	2600	2945	3295	3640	3990	4335	4685	4855	5030	
30 km/h	1730	1905	2085	2435	2790	3145	3495	3850				
40 km/h			1970	2310	2650	2990	3330	3670				
40 km/h Dual	1445	1590	1735	2035	2335	2630	2930	3230				
50 km/h			1890	2215	2540	2870	3195	3520				
65 km/h			1800	2110	2420	2730	3040	3350				

* Refer to the notes at the end of the tables of this range

MICHELIN OMNIBIB

Tire specifications and pressure table (bar & psi). Load per tire in kg*

Ø inches	Description	CAI	e mm	D mm	R' mm	RC mm	Recommended Rim	Acceptable Rim	Tube (Code)	75% internal volume (litres)	Tread depth (mm)
38	580/70R38 155D TL	001240	601	1836	815	5440	DW18L	W18L	825	590	56
Bar	0.4	0.5	0.6	0.8	1	1.2	1.4	1.6	1.8	1.9	2
Psi	6	7	9	12	15	17	20	23	26	28	29
10 km/h	2630	2830	3030	3425	3825	4220	4620	5015	5415	5610	5810
30 km/h	2010	2215	2420	2825	3235	3645	4050	4460			
40 km/h			2320	2705	3090	3470	3855	4240			
40 km/h Dual	1685	1865	2045	2385	2720	3060	3395	3735			
50 km/h			2230	2600	2965	3335	3700	4070			
65 km/h			2120	2470	2820	3175	3525	3875			

Ø inches	Description	CAI	e mm	D mm	R' mm	RC mm	Recommended Rim	Acceptable Rim	Tube (Code)	75% internal volume (litres)	Tread depth (mm)
42	620/70R42 160D TL	989457	639	1953	863	5781	DW20B (A)	DW18L	802	658	58
Bar	0.4	0.5	0.6	0.8	1	1.2	1.4	1.6	1.8	1.9	2
Psi	6	7	9	12	15	17	20	23	26	28	29
10 km/h	3090	3320	3550	4005	4465	4920	5380	5835	6295	6520	6750
30 km/h	2370	2605	2840	3305	3775	4245	4710	5180			
40 km/h			2660	3115	3570	4020	4475	4930			
40 km/h Dual	1985	2165	2340	2740	3140	3535	3935	4335			
50 km/h			2550	2985	3420	3860	4295	4730			
65 km/h			2430	2845	3260	3670	4085	4500			

***IMPORTANT:**

The inflation pressure must always be appropriate for the load per tire, the speed of travel and the work to be done. Our recommendations above are provided subject to changes made after the date of publication of these tables (July 2020). Technical data is subject to change without prior notice.

- For plowing and other field applications subject to high torque, use the 30 km/h line.
- When using single tire configuration:
 - add 0.4 bar for use on slopes of more than 20%
 - add 0.4 bar for intensive road use exceeding 50% of time on road
- 10 km/h LT (Low Torque) (max speed 10 km/h).

TRACTORS

HIGH POWER



MICHELIN YIELDBIB

THE LOW-PRESSURE TIRE
FOR HIGH-POWERED
ROW-CROP APPLICATIONS



FOR TRACTORS FROM **160 TO 550 HP**



VF VERY HIGH FLEXION



SOIL PROTECTION

+27% wider footprint to protect soil from compaction and improve yields ⁽¹⁾



MORE TRACTION

with **45° designed lugs** ⁽²⁾



PRODUCTIVITY

carry **up to 40% more load** at the same pressure versus non-VF radial tire in the same size

(1) Michelin test 2016, VF 480/80 R50 Yieldbib vs 480/80 R50 AGRIBIB.

(2) Compared to standard competitor's tires with 23° lugs

SIZES

VF 380/85R34 149A8/149B TL

VF 420/85R34 154A8/154B TL

VF 380/80R38 149A8/149B TL

VF 380/95R38 154A8/154B TL

VF 480/80R46 164A8/164B TL

VF 480/80R50 166A8/166B TL

VF 480/95R50 170A8/170B TL

MICHELIN YIELDBIB

Tire specifications and pressure table (bar & psi). Load per tire in kg*

Ø inches	Description	CAI	e mm	D mm	R' mm	RC mm	Recommended Rim			Acceptable Rim		Tube (Code)	75% internal volume (litres)	Tread depth (mm)
34	VF 380/85R34 149A8/149B TL	305457	372	1510	668	4471	W13			W12		704	230	44
Bar	0.4	0.5	0.6	0.7	0.8	0.9	1	1.1	1.2	1.3	1.4	1.5	1.6	
Psi	6	7	9	10	12	13	15	16	17	19	20	22	23	
10 km/h	1595	1760	1925	2090	2255	2420	2585	2750	2915	3080	3245	3410	3575	
30 km/h	1480	1635	1785	1940	2090	2245	2400	2550	2705	2860	3010	3165	3315	
30 km/h Dual	1300	1435	1570	1705	1840	1975	2110	2245	2380	2515	2650	2780	2915	
30 km/h Triple	1215	1340	1465	1590	1715	1840	1970	2095	2220	2345	2470	2595	2720	
50 km/h	1450	1600	1750	1900	2050	2200	2350	2500	2650	2800	2950	3100	3250	
50 km/h Dual	1280	1410	1545	1675	1805	1940	2070	2205	2335	2465	2600	2730	2860	
50 km/h Triple	1190	1315	1435	1560	1680	1805	1930	2050	2175	2300	2420	2545	2665	

Ø inches	Description	CAI	e mm	D mm	R' mm	RC mm	Recommended Rim			Acceptable Rim		Tube (Code)	75% internal volume (litres)	Tread depth (mm)
34	VF 420/85R34 154A8/154B TL	012445	432	1582	699	4682	DW15L			W14L W15A (L) DW14A (L)		704	287	48
Bar	0.4	0.5	0.6	0.7	0.8	0.9	1	1.1	1.2	1.3	1.4	1.5	1.6	
Psi	6	7	9	10	12	13	15	16	17	19	20	22	23	
10 km/h	1870	2060	2250	2440	2630	2820	3010	3195	3385	3570	3755	3940	4125	
30 km/h	1735	1910	2090	2265	2440	2615	2790	2960	3135	3310	3480	3655	3825	
30 km/h Dual	1525	1680	1835	1990	2145	2300	2455	2605	2760	2910	3065	3215	3365	
30 km/h Triple	1425	1570	1715	1855	2000	2145	2285	2430	2570	2710	2855	2995	3135	
50 km/h	1700	1875	2045	2220	2390	2560	2735	2905	3075	3245	3415	3580	3750	
50 km/h Dual	1500	1650	1805	1955	2105	2255	2405	2555	2705	2855	3005	3150	3300	
50 km/h Triple	1395	1535	1680	1820	1960	2100	2240	2380	2520	2660	2800	2935	3075	

Ø inches	Description	CAI	e mm	D mm	R' mm	RC mm	Recommended Rim			Acceptable Rim		Tube (Code)	75% internal volume (litres)	Tread depth (mm)
38	VF 380/80R38 149A8/149B TL	870363	366	1592	711	4851	DW12A			W12 W13		796 795	230	45
Bar	0.4	0.5	0.6	0.7	0.8	0.9	1	1.1	1.2	1.3	1.4	1.5	1.6	
Psi	6	7	9	10	12	13	15	16	17	19	20	22	23	
10 km/h	1595	1760	1930	2095	2260	2425	2590	2755	2920	3085	3250	3410	3575	
30 km/h	1480	1635	1790	1940	2095	2250	2405	2555	2710	2860	3015	3165	3315	
30 km/h Dual	1300	1435	1575	1710	1845	1980	2115	2250	2385	2520	2650	2785	2915	
30 km/h Triple	1215	1340	1470	1595	1720	1845	1970	2095	2220	2345	2470	2595	2720	
50 km/h	1450	1600	1755	1905	2055	2205	2355	2505	2655	2805	2955	3100	3250	
50 km/h Dual	1280	1415	1550	1680	1815	1945	2080	2210	2340	2470	2600	2730	2860	
50 km/h Triple	1190	1315	1440	1560	1685	1810	1935	2055	2180	2300	2425	2545	2665	

* Refer to the notes at the end of the tables of this range

MICHELIN YIELDBIB

Tire specifications and pressure table (bar & psi). Load per tire in kg*

Ø inches	Description	CAI	e mm	D mm	R' mm	RC mm	Recommended Rim	Acceptable Rim	Tube (Code)	75% internal volume (litres)	Tread depth (mm)		
38	VF 380/95R38 154A8/154B TL	873023	377	1703	755	5044	DW12A	W12	795 796	286	47		
Bar	0.4	0.5	0.6	0.7	0.8	0.9	1	1.1	1.2	1.3	1.4	1.5	1.6
Psi	6	7	9	10	12	13	15	16	17	19	20	22	23
10 km/h	1870	2060	2250	2435	2625	2810	3000	3185	3370	3560	3750	3935	4125
30 km/h	1735	1910	2085	2260	2435	2610	2780	2955	3125	3300	3475	3650	3825
30 km/h Dual	1525	1680	1835	1990	2145	2295	2450	2600	2750	2905	3060	3210	3365
30 km/h Triple	1425	1570	1710	1855	1995	2140	2280	2425	2565	2710	2850	2995	3135
50 km/h	1700	1870	2045	2215	2385	2555	2725	2895	3065	3235	3410	3580	3750
50 km/h Dual	1500	1650	1800	1950	2100	2250	2400	2550	2700	2850	3000	3150	3300
50 km/h Triple	1400	1540	1680	1815	1955	2095	2235	2375	2515	2655	2795	2935	3075

Ø inches	Description	CAI	e mm	D mm	R' mm	RC mm	Recommended Rim	Acceptable Rim	Tube (Code)	75% internal volume (litres)	Tread depth (mm)		
46	VF 480/80R46 164A8/164B TL	842300	480	1933	861	5732	DW16A	DW16L W16A DW15L DW16B	834	449	52		
Bar	0.4	0.5	0.6	0.7	0.8	0.9	1	1.1	1.2	1.3	1.4	1.5	1.6
Psi	6	7	9	10	12	13	15	16	17	19	20	22	23
10 km/h	2530	2780	3025	3275	3520	3770	4015	4265	4510	4760	5005	5255	5500
30 km/h	2345	2575	2805	3035	3265	3495	3725	3950	4180	4410	4640	4870	5100
30 km/h Dual	2065	2270	2470	2675	2875	3075	3280	3480	3680	3885	4085	4290	4490
30 km/h Triple	1925	2115	2300	2490	2675	2865	3055	3240	3430	3620	3805	3995	4180
50 km/h	2300	2525	2750	2975	3200	3425	3650	3875	4100	4325	4550	4775	5000
50 km/h Dual	2025	2225	2420	2620	2815	3015	3215	3410	3610	3810	4005	4205	4400
50 km/h Triple	1885	2070	2255	2440	2625	2810	2995	3175	3360	3545	3730	3915	4100

Ø inches	Description	CAI	e mm	D mm	R' mm	RC mm	Recommended Rim	Acceptable Rim	Tube (Code)	75% internal volume (litres)	Tread depth (mm)		
50	VF 480/80R50 166A8/166B TL	309830	468	2039	901	6034	DW16A(L)	DW15L DW15B (A) W15B (A) DW16B W16B		479	49		
Bar	0.4	0.5	0.6	0.7	0.8	0.9	1	1.1	1.2	1.3	1.4	1.5	1.6
Psi	6	7	9	10	12	13	15	16	17	19	20	22	23
10 km/h	2595	2855	3115	3375	3635	3895	4155	4415	4675	4935	5195	5455	5715
30 km/h	2405	2645	2890	3130	3370	3610	3855	4095	4335	4605	4870	5140	5405
30 km/h Dual	2115	2330	2540	2755	2965	3180	3390	3605	3815	4050	4285	4520	4755
30 km/h Triple	1970	2170	2370	2565	2765	2965	3160	3360	3555	3775	3995	4210	4430
50 km/h	2360	2595	2835	3070	3305	3540	3780	4015	4250	4515	4775	5040	5300
50 km/h Dual	2075	2285	2495	2700	2910	3120	3325	3535	3740	3970	4200	4430	4660
50 km/h Triple	1930	2125	2320	2515	2710	2905	3100	3295	3490	3705	3920	4135	4350

* Refer to the notes at the end of the tables of this range

MICHELIN YIELDBIB

Tire specifications and pressure table (bar & psi). Load per tire in kg*

Ø inches	Description	CAI	e mm	D mm	R' mm	RC mm	Recommended Rim		Acceptable Rim		Tube (Code)	75% internal volume (litres)	Tread depth (mm)
50	VF 480/95R50 170A8/170B TL	252129	477	2186	962	6464	DW16L		DW15L (NRO) W15L (NRO) W16L			593	51
Bar	0.4	0.5	0.6	0.7	0.8	0.9	1	1.1	1.2	1.3	1.4	1.5	1.6
Psi	6	7	9	10	12	13	15	16	17	19	20	22	23
10 km/h	3000	3315	3625	3940	4250	4565	4875	5190	5500	5775	6050	6325	6600
30 km/h	2780	3070	3360	3650	3940	4230	4520	4810	5100	5355	5610	5865	6120
30 km/h Dual	2445	2700	2955	3210	3465	3720	3980	4235	4490	4715	4940	5160	5385
30 km/h Triple	2280	2520	2755	2995	3230	3470	3705	3945	4180	4390	4600	4810	5020
50 km/h	2725	3010	3295	3580	3865	4150	4435	4715	5000	5250	5500	5750	6000
50 km/h Dual	2400	2650	2900	3150	3400	3650	3900	4150	4400	4620	4840	5060	5280
50 km/h Triple	2235	2470	2705	2935	3170	3405	3635	3870	4100	4305	4510	4715	4920

***IMPORTANT:**

The inflation pressure must always be appropriate for the load per tire, the speed of travel and the work to be done. Our recommendations above are provided subject to changes made after the date of publication of these tables (July 2020). Technical data is subject to change without prior notice.

- When using single tire configuration:
 - add 0.4 bar for use on slopes of more than 20%
 - add 0.4 bar for intense road use exceeding 50% of time on road

TRACTORS

HIGH POWER



MICHELIN AGRIBIB 2

HIGH LEVELS OF PERFORMANCE THROUGHOUT ITS LIFE



FOR TRACTORS UP TO 220 HP

and up to 500 HP with dual and triple fitments (42", 46", 50")



OPTIMAL TRACTION

with 45° lug angle



SERVICE LIFE thanks to deep tread lugs

up to 8% deeper tread than leading competitors R1W Radial type tire offer⁽¹⁾



ROBUSTNESS

up to 18% higher load index⁽²⁾

(1) MICHELIN AGRIBIB 2 480/80R50 vs leading competitors published depths

(2) Depending on size & for size 520/85 R46 164A8/164B

SIZES

480/80R26 149A8/149B TL

280/85R28 123A8/120D TL

420/85R28 144A8/144B TL

380/85R30 140A8/140B TL

420/85R30 145A8/145B TL

420/90R30 147A8/147B TL

650/75R32 167A8/167B TL

320/85R34 133A8/133B TL

380/85R34 142A8/142B TL

420/85R34 147A8/147B TL

380/80R38 142A8/139D TL

420/85R38 149A8/149B TL

520/85R38 160A8/160B TL

480/80R42 156A8/156B TL

520/85R42 162A8/162B TL

420/80R46 151A8/151B TL

480/80R46 158A8/158B TL

520/85R46 164A8/164B TL

480/80R50 159A8/159B TL

380/90R54 152A8/152B TL

MICHELIN AGRIBIB 2

Tire specifications and pressure table (bar & psi). Load per tire in kg*

Ø inches	Description	CAI	e mm	D mm	R' mm	RC mm	Recommended Rim	Acceptable Rim	Tube (Code)	75% internal volume (litres)	Tread depth (mm)		
26	480/80R26 149A8/149B TL <i>South America</i>	466081	500	1416	633	4202	DW16B(A)	DW15B(A)		297	51.5		
Bar	0.4 0.6 0.8 1 1.2 1.4 1.6 1.8 2 2.2 2.4 2.6 2.8												
Psi	6 9 12 15 17 20 23 26 29 32 35 38 41												
10 km/h	1875	2245	2620	2990	3360	3555	3750	3975	4200	4370	4540	4705	4875
30 km/h	1340	1605	1875	2135	2395	2655	2915	3055	3200	3340	3480		
40 km/h		1500	1750	1995	2240	2485	2725	2855	2990	3120	3250		
40 km/h Dual		1320	1540	1755	1970	2185	2400	2515	2630	2745	2860		
50 km/h		1500	1750	1995	2240	2485	2725	2855	2990	3120	3250		

Ø inches	Description	CAI	e mm	D mm	R' mm	RC mm	Recommended Rim	Acceptable Rim	Tube (Code)	75% internal volume (litres)	Tread depth (mm)		
28	280/85R28 123A8/120B TL	392931	299	1192	545	3563	W10	W9	725	98	40		
Bar	0.4 0.6 0.8 1 1.2 1.4 1.6 1.8 2 2.2 2.4 2.6 2.8												
Psi	6 9 12 15 17 20 23 26 29 32 35 38 41												
10 km/h	900	1075	1245	1420	1590	1680	1770	1905	2040	2110	2185	2255	2325
30 km/h	640	760	885	1010	1135	1275	1410	1475	1535	1600	1660		
40 km/h		710	825	945	1060	1190	1320	1380	1435	1495	1550		
40 km/h Dual		625	725	830	935	1050	1160	1210	1265	1315	1365		
50 km/h		645	750	860	965	1085	1200	1255	1305	1360	1410		
65 km/h		645	750	860	965	1085	1200	1255	1305	1360	1410		

Ø inches	Description	CAI	e mm	D mm	R' mm	RC mm	Recommended Rim	Acceptable Rim	Tube (Code)	75% internal volume (litres)	Tread depth (mm)		
28	420/85R28 144A8/144B TL <i>South America</i>	135905	449	1419	645	4226	DW15L	DW14L W14L W15L	822	248	49		
Bar	0.4 0.6 0.8 1 1.2 1.4 1.6 1.8 2 2.2 2.4 2.6 2.8												
Psi	6 9 12 15 17 20 23 26 29 32 35 38 41												
10 km/h	1680	2010	2340	2670	3000	3180	3360	3555	3750	3865	3975	4090	4200
30 km/h	1200	1410	1660	1900	2140	2370	2600	2700	2800	2895	2995		
40 km/h		1320	1550	1775	2000	2215	2430	2525	2615	2710	2800		
40 km/h Dual		1160	1365	1565	1760	1950	2140	2220	2305	2385	2465		
50 km/h		1320	1550	1775	2000	2215	2430	2525	2615	2710	2800		

* Refer to the notes at the end of the tables of this range

MICHELIN AGRIBIB 2

Tire specifications and pressure table (bar & psi). Load per tire in kg*

Ø inches	Description	CAI	e mm	D mm	R' mm	RC mm	Recommended Rim	Acceptable Rim	Tube (Code)	75% internal volume (litres)	Tread depth (mm)		
30	380/85R30 140A8/140B TL <i>14.9 R30</i>	151572	394	1416	644	4219	W12	W13	734	229	46.5		
Bar	0.4 0.6 0.8	1	1.2	1.4	1.6	1.8	2	2.2	2.4	2.6	2.8		
Psi	6 9 12	15	17	20	23	26	29	32	35	38	41		
10 km/h	1465	1755	2045	2335	2625	2775	2925	3145	3360	3460	3555	3655	3750
30 km/h	1045	1265	1455	1665	1875	2105	2335	2420	2505	2590	2675		
40 km/h	1180	1360	1555	1750	1965	2180	2260	2340	2420	2500			
40 km/h Dual	1040	1195	1370	1540	1730	1920	1990	2060	2130	2200			
50 km/h	1180	1360	1555	1750	1965	2180	2260	2340	2420	2500			

Ø inches	Description	CAI	e mm	D mm	R' mm	RC mm	Recommended Rim	Acceptable Rim	Tube (Code)	75% internal volume (litres)	Tread depth (mm)		
30	420/85R30 145A8/145B TL <i>South America</i>	002919	455	1472	661	4373	DW15L	DW14L W14L W15L	754	279	48.5		
Bar	0.4 0.6 0.8	1	1.2	1.4	1.6	1.8	2	2.2	2.4	2.6	2.8		
Psi	6 9 12	15	17	20	23	26	29	32	35	38	41		
10 km/h	1725	2065	2410	2750	3090	3270	3450	3660	3865	3985	4110	4230	4350
30 km/h	1230	1455	1710	1960	2205	2440	2675	2785	2890	3000	3105		
40 km/h	1360	1600	1830	2060	2280	2500	2600	2700	2800	2900			
40 km/h Dual	1195	1410	1615	1815	2010	2200	2290	2375	2465	2550			
50 km/h	1360	1600	1830	2060	2280	2500	2600	2700	2800	2900			

Ø inches	Description	CAI	e mm	D mm	R' mm	RC mm	Recommended Rim	Acceptable Rim	Tube (Code)	75% internal volume (litres)	Tread depth (mm)		
30	420/90R30 147A8/147B TL <i>16.9 R30</i>	508522	418	1518	684	4513	DW13	W13 DW14L W14L	754	284	50		
Bar	0.4 0.6 0.8	1	1.2	1.4	1.6	1.8	2	2.2	2.4	2.6	2.8		
Psi	6 9 12	15	17	20	23	26	29	32	35	38	41		
10 km/h	1825	2120	2420	2715	3015	3310	3605	3905	4200	4305	4410	4510	4615
30 km/h	1300	1550	1810	2075	2335	2585	2835	2970	3105	3200	3290		
40 km/h	1450	1700	1940	2180	2415	2650	2775	2900	2990	3075			
40 km/h Dual	1070	1275	1495	1710	1920	2125	2330	2425	2520	2610	2705		
50 km/h	1450	1700	1940	2180	2415	2650	2775	2900	2990	3075			

* Refer to the notes at the end of the tables of this range

MICHELIN AGRIBIB 2

Tire specifications and pressure table (bar & psi). Load per tire in kg*

Ø inches	Description	CAI	e mm	D mm	R' mm	RC mm	Recommended Rim	Acceptable Rim	Tube (Code)	75% internal volume (litres)	Tread depth (mm)
32	650/75R32 167A8/167B TL <i>South America</i>	533727	667	1827	811	5395	DW20B (A)	DW21B (A)	831	647	49
Bar	0.4 0.6 0.8	1 1.2 1.4	1.6 1.8 2	2.2 2.4	2.6 2.8						
Psi	6 9 12	15 17 20	23 26 29	32 35	38 41						
10 km/h	3180 3840 4500	5155 5815 6095	6375 6750 7125	7390 7650	7915 8175						
30 km/h	2270 2755 3210	3680 4145 4550	4950 5170 5390	5610 5830							
40 km/h	2575 3000 3440	3875 4250 4625	4830 5040 5245	5450							
40 km/h Dual	2265 2640 3025	3410 3740 4070	4250 4435 4615	4795							
50 km/h	2575 3000 3440	3875 4250 4625	4830 5040 5245	5450							

Ø inches	Description	CAI	e mm	D mm	R' mm	RC mm	Recommended Rim	Acceptable Rim	Tube (Code)	75% internal volume (litres)	Tread depth (mm)
34	320/85R34 133A8/133B TL <i>12.4 R34</i>	908266	312	1421	653	4243	W10			155	44
Bar	0.4 0.6 0.8	1 1.2 1.4	1.6 1.8 2	2.2 2.4	2.6 2.8						
Psi	6 9 12	15 17 20	23 26 29	32 35	38 41						
10 km/h	1200 1445 1690	1930 2175 2290	2400 2550 2700	2800 2895	3090						
30 km/h	855 1045 1200	1375 1550 1715	1875 1960 2040	2125 2205							
40 km/h	975 1120 1285	1450 1600 1750	1830 1905 1985	2060							
40 km/h Dual	705 860 985	1130 1275 1410	1540 1610 1680	1745 1815							
50 km/h	975 1120 1285	1450 1600 1750	1830 1905 1985	2060							

Ø inches	Description	CAI	e mm	D mm	R' mm	RC mm	Recommended Rim	Acceptable Rim	Tube (Code)	75% internal volume (litres)	Tread depth (mm)
34	380/85R34 142A8/142B TL <i>14.9 R34</i>	009860	377.5	1516	691	4519	W12	W13	704	286	46.5
Bar	0.4 0.6 0.8	1 1.2 1.4	1.6 1.8 2	2.2 2.4	2.6 2.8						
Psi	6 9 12	15 17 20	23 26 29	32 35	38 41						
10 km/h	1545 1855 2160	2470 2775 2935	3090 3315 3540	3650 3760	3865 3975						
30 km/h	1100 1340 1550	1765 1980 2220	2460 2555 2650	2740 2835							
40 km/h	1250 1450 1650	1850 2075 2300	2390 2475 2565	2650							
40 km/h Dual	1100 1275 1455	1630 1830 2025	2100 2180 2255	2330							
50 km/h	1250 1450 1650	1850 2075 2300	2390 2475 2565	2650							

* Refer to the notes at the end of the tables of this range

MICHELIN AGRIBIB 2

Tire specifications and pressure table (bar & psi). Load per tire in kg*

Ø inches	Description	CAI	e mm	D mm	R' mm	RC mm	Recommended Rim	Acceptable Rim	Tube (Code)	75% internal volume (litres)	Tread depth (mm)		
34	420/85R34 147A8/147B TL <i>16.9 R34</i>	183733	449	1589	720	4730	DW15L	W13 DW14L W14L W15L	704	287	48.5		
Bar	0.4 0.6 0.8 1 1.2 1.4 1.6 1.8 2 2.2 2.4 2.6 2.8												
Psi	6 9 12 15 17 20 23 26 29 32 35 38 41												
10 km/h	1300	1795	2285	2780	3270	3460	3645	3870	4090	4220	4355	4485	4615
30 km/h	1300	1550	1820	2080	2335	2585	2835	2950	3065	3175	3290		
40 km/h		1450	1700	1940	2180	2415	2650	2755	2865	2970	3075		
40 km/h Dual	1070	1275	1495	1710	1920	2125	2330	2425	2520	2610	2705		
50 km/h		1450	1700	1940	2180	2415	2650	2755	2865	2970	3075		

Ø inches	Description	CAI	e mm	D mm	R' mm	RC mm	Recommended Rim	Acceptable Rim	Tube (Code)	75% internal volume (litres)	Tread depth (mm)		
38	380/80R38 142A8/139D TL <i>14.9 R38</i>	187095	380	1595	729	4755	DW12A	W11 DW12 W12 W13 DW13 DW11	795 796	230	46		
Bar	0.4 0.6 0.8 1 1.2 1.4 1.6 1.8 2 2.2 2.4 2.6 2.8												
Psi	6 9 12 15 17 20 23 26 29 32 35 38 41												
10 km/h	1545	1870	2200	2525	2850	2970	3090	3315	3540	3650	3760	3865	3975
30 km/h	1100	1340	1550	1795	2035	2250	2460	2555	2650	2740	2835		
40 km/h		1250	1450	1675	1900	2100	2300	2390	2475	2565	2650		
40 km/h Dual		1100	1275	1475	1670	1850	2025	2100	2180	2255	2330		
50 km/h		1250	1450	1675	1900	2100	2300	2390	2475	2565	2650		
65 km/h		1140	1320	1525	1730	1915	2095	2175	2255	2330	2410		

Ø inches	Description	CAI	e mm	D mm	R' mm	RC mm	Recommended Rim	Acceptable Rim	Tube (Code)	75% internal volume (litres)	Tread depth (mm)		
38	420/85R38 149A8/149B TL <i>16.9 R38</i>	048439	450	1690	769	5035	DW15L	DW14L W14L W15L	786	293	49		
Bar	0.4 0.6 0.8 1 1.2 1.4 1.6 1.8 2 2.2 2.4 2.6 2.8												
Psi	6 9 12 15 17 20 23 26 29 32 35 38 41												
10 km/h	1930	2250	2575	2895	3215	3535	3860	4180	4500	4595	4690	4780	4875
30 km/h	1375	1660	1925	2195	2460	2730	2995	3145	3290	3385	3480		
40 km/h		1550	1800	2050	2300	2550	2800	2940	3075	3165	3250		
40 km/h Dual	1130	1365	1585	1805	2025	2245	2465	2565	2665	2760	2860		
50 km/h		1550	1800	2050	2300	2550	2800	2940	3075	3165	3250		

* Refer to the notes at the end of the tables of this range

MICHELIN AGRIBIB 2

Tire specifications and pressure table (bar & psi). Load per tire in kg*

Ø inches	Description	CAI	e mm	D mm	R' mm	RC mm	Recommended Rim	Acceptable Rim	Tube (Code)	75% internal volume (litres)	Tread depth (mm)														
38	520/85R38 160A8/160B TL 20.8 R38	882358	533	1849	831	5493	DW16L	DD16 W16A DD18 DW18L W18A	825	508	55														
												Bar	0.4	0.6	0.8	1	1.2	1.4	1.6	1.8	2	2.2	2.4	2.6	2.8
												Psi	6	9	12	15	17	20	23	26	29	32	35	38	41
												10 km/h	2625	3070	3515	3960	4410	4855	5300	5745	6190	6330	6470	6610	6750
												30 km/h	1875	2270	2635	3005	3370	3760	4145	4350	4550	4685	4815		
												40 km/h		2120	2500	2825	3150	3515	3875	4065	4250	4375	4500		
												40 km/h Dual	1540	1865	2200	2485	2770	3090	3410	3550	3685	3825	3960		
												50 km/h		2120	2500	2825	3150	3515	3875	4065	4250	4375	4500		

Ø inches	Description	CAI	e mm	D mm	R' mm	RC mm	Recommended Rim	Acceptable Rim	Tube (Code)	75% internal volume (litres)	Tread depth (mm)														
42	480/80R42 156A8/156B TL 18.4 R42	539386	489	1840	837	5470	DW16A	DD16 W16A	801	412	52														
												Bar	0.4	0.6	0.8	1	1.2	1.4	1.6	1.8	2	2.2	2.4	2.6	2.8
												Psi	6	9	12	15	17	20	23	26	29	32	35	38	41
												10 km/h	2325	2720	3115	3505	3900	4295	4690	5080	5475	5605	5740	5870	6000
												30 km/h	1660	1980	2320	2655	2995	3345	3690	3855	4015	4150	4280		
												40 km/h		1850	2180	2490	2800	3125	3450	3600	3750	3875	4000		
												40 km/h Dual	1365	1630	1920	2195	2465	2750	3035	3155	3280	3400	3520		
												50 km/h		1850	2180	2490	2800	3125	3450	3600	3750	3875	4000		

Ø inches	Description	CAI	e mm	D mm	R' mm	RC mm	Recommended Rim	Acceptable Rim	Tube (Code)	75% internal volume (litres)	Tread depth (mm)														
42	520/85R42 162A8/162B TL 20.8 R42	405859	542	1958	886	5810	DW18A	DW16A DW16L W16A TW16L DD18 W18A W16L	802	545	55														
												Bar	0.4	0.6	0.8	1	1.2	1.4	1.6	1.8	2	2.2	2.4	2.6	2.8
												Psi	6	9	12	15	17	20	23	26	29	32	35	38	41
												10 km/h	2775	3250	3725	4195	4670	5145	5620	6090	6565	6705	6845	6985	7125
												30 km/h	1980	2395	2790	3190	3585	4000	4415	4615	4815	4950	5085		
												40 km/h		2240	2575	2965	3350	3740	4125	4315	4500	4625	4750		
												40 km/h Dual	1630	1970	2265	2610	2950	3290	3630	3770	3905	4045	4180		

* Refer to the notes at the end of the tables of this range

MICHELIN AGRIBIB 2

Tire specifications and pressure table (bar & psi). Load per tire in kg*

50 km/h	2240	2575	2965	3350	3740	4125	4315	4500	4625	4750
---------	------	------	------	------	------	------	------	------	------	------

Ø inches	Description	CAI	e mm	D mm	R' mm	RC mm	Recommended Rim	Acceptable Rim	Tube (Code)	75% internal volume (litres)	Tread depth (mm)		
46	420/80R46 151A8/151B TL	885138	410	1854	844	5524	DW13	DW12	835	334	50		
Bar	0.4	0.6	0.8	1	1.2	1.4	1.6	1.8	2	2.2	2.4	2.6	2.8
Psi	6	9	12	15	17	20	23	26	29	32	35	38	41
10 km/h	1980	2395	2815	3230	3645	3810	3975	4240	4500	4670	4840	5005	5175
30 km/h	1410	1710	1980	2290	2600	2855	3105	3250	3400	3545	3690		
40 km/h		1600	1850	2140	2430	2665	2900	3040	3175	3315	3450		
40 km/h Dual	1160	1410	1630	1885	2140	2345	2550	2670	2795	2915	3035		
50 km/h		1600	1850	2140	2430	2665	2900	3040	3175	3315	3450		

Ø inches	Description	CAI	e mm	D mm	R' mm	RC mm	Recommended Rim	Acceptable Rim	Tube (Code)	75% internal volume (litres)	Tread depth (mm)		
46	480/80R46 158A8/158B TL <i>18.4 R46</i>	622709	486	1945	891	5804	DW16A	DD16 DW16L W16A	834	449	52		
Bar	0.4	0.6	0.8	1	1.2	1.4	1.6	1.8	2	2.2	2.4	2.6	2.8
Psi	6	9	12	15	17	20	23	26	29	32	35	38	41
10 km/h	2475	2945	3415	3880	4350	4615	4875	5175	5475	5700	5925	6150	6375
30 km/h	1765	2085	2460	2785	3105	3455	3800	3990	4175	4365	4550		
40 km/h		1950	2300	2600	2900	3225	3550	3725	3900	4075	4250		
40 km/h Dual		1715	2025	2290	2550	2840	3125	3280	3435	3585	3740		
50 km/h		1950	2300	2600	2900	3225	3550	3725	3900	4075	4250		

Ø inches	Description	CAI	e mm	D mm	R' mm	RC mm	Recommended Rim	Acceptable Rim	Tube (Code)	75% internal volume (litres)	Tread depth (mm)		
46	520/85R46 164A8/164B TL <i>20.8 R46</i>	120922	518	2059	931	6110	DW16A	DW16L W16A TW16L DW18L W18L W16L W18A DW18A	834	560	55		
Bar	0.4	0.6	0.8	1	1.2	1.4	1.6	1.8	2	2.2	2.4	2.6	2.8
Psi	6	9	12	15	17	20	23	26	29	32	35	38	41
10 km/h	2925	3425	3930	4430	4935	5435	5935	6440	6940	7035	7130	7220	7315
30 km/h	2085	2460	2870	3280	3690	4120	4550	4750	4950	5150	5350		
40 km/h		2300	2725	3090	3450	3850	4250	4440	4625	4815	5000		
40 km/h Dual	1715	2025	2400	2720	3035	3390	3740	3905	4070	4235	4400		
50 km/h		2300	2725	3090	3450	3850	4250	4440	4625	4815	5000		

* Refer to the notes at the end of the tables of this range

MICHELIN AGRIBIB 2

Tire specifications and pressure table (bar & psi). Load per tire in kg*

Ø inches	Description			CAI	e mm	D mm	R' mm	RC mm	Recommended Rim		Acceptable Rim		Tube (Code)	75% internal volume (litres)	Tread depth (mm)
50	480/80R50 159A8/159B TL			263049	465	2050	938	6116	DW15A	DW16A				483	52
Bar	0.4	0.6	0.8	1	1.2	1.4	1.6	1.8	2	2.2	2.4	2.6	2.8		
Psi	6	9	12	15	17	20	23	26	29	32	35	38	41		
10 km/h	2550	3065	3585	4100	4615	4895	5175	5495	5815	6005	6190	6380	6565		
30 km/h	1820	2205	2525	2910	3290	3655	4015	4180	4350	4515	4680				
40 km/h		2060	2360	2720	3075	3415	3750	3905	4065	4220	4375				
40 km/h Dual		1815	2075	2390	2705	3005	3300	3440	3575	3715	3850				
50 km/h		2060	2360	2720	3075	3415	3750	3905	4065	4220	4375				

Ø inches	Description			CAI	e mm	D mm	R' mm	RC mm	Recommended Rim		Acceptable Rim		Tube (Code)	75% internal volume (litres)	Tread depth (mm)
54	380/90R54 152A8/152B TL			075615	386	2054	949	6129	W12A	DW13B				334	50
Bar	0.4	0.6	0.8	1	1.2	1.4	1.6	1.8	2	2.2	2.4	2.6	2.8		
Psi	6	9	12	15	17	20	23	26	29	32	35	38	41		
10 km/h	2040	2470	2895	3325	3750	3920	4090	4410	4725	4875	5025	5175	5325		
30 km/h	1455	1765	2085	2380	2675	2945	3210	3360	3505	3655	3800				
40 km/h		1650	1950	2225	2500	2750	3000	3140	3275	3415	3550				
40 km/h Dual		1450	1715	1960	2200	2420	2640	2760	2885	3005	3125				
50 km/h		1650	1950	2225	2500	2750	3000	3140	3275	3415	3550				

***IMPORTANT:**

The inflation pressure must always be appropriate for the load per tire, the speed of travel and the work to be done. Our recommendations above are provided subject to changes made after the date of publication of these tables (July 2020). Technical data is subject to change without prior notice.

- For plowing and other field applications subject to high torque, use the 30 km/h line.
- When using single tire configuration:
 - add 0.4 bar for use on slopes of more than 20%
 - add 0.4 bar for intensive road use exceeding 50% of time on road
- 10 km/h LT (Low Torque) (max speed 10 km/h).

TRACTORS

LOW & MEDIUM POWER



MICHELIN AGRIBIB

HIGH PERFORMANCE
WITH OPTIMAL TRACTION



FOR TRACTORS UP TO 220 HP

and up to 500 HP with dual and triple fitments (42", 46", 50")



OPTIMAL TRACTION

- Maintains traction throughout its life, even when worn



EXCELLENT SERVICE LIFE thanks to deep tread lugs



ROBUSTNESS

- Proven radial casing endurance
- Damage-resistant rubber

SIZES

9.5R24 112A8/109B TL	16.9R28 141A8/138B TL	12.4R36 124A8/121B TL	520/85R42 157A8/157B TL
11.2R24 119A8/116B TL	380/85R30 135A8/135B TL	12.4R38 131A8/128B TL	420/80R46 151A8/148B TL
12.4R24 119A8/116B TL	16.9R30 137A8/134B TL	13.6R38 128A8/125B TL	480/80R46 158A8/158B TL
13.6R24 124A8/121B TL	420/90R30 147A8/147B TL	420/85R38 144A8/144B TL	520/85R46 158A8/155B TL
14.9R24 130A8/127B TL	18.4R30 142A8/139B TL	380/95R38 147A8/147B TL	480/80R50 159A8/159B TL
16.9R24 134A8/131B TL	320/85R34 133A8/130B TL	18.4R38 151A8/148B TL	480/95R50 164A8/164B TL
12.4R28 126A8/123B TL	380/85R34 137A8/137B TL	20.8R38 159A8/156B TL	
13.6R28 123A8/120B TL	420/85R34 147A8/147B TL	520/85R38 155A8/155B TL	
14.9R28 134A8/131B TL	18.4R34 149A8/146B TL	480/80R42 156A8/156B TL	

MICHELIN AGRIBIB

Tire specifications and pressure table (bar & psi). Load per tire in kg*

Ø inches	Description	CAI	e mm	D mm	R' mm	RC mm	Recommended Rim	Acceptable Rim	Tube (Code)	75% internal volume (litres)	Tread depth (mm)		
24	9.5R24 112A8/109B TL	200987	253	1045	481	3117	W8	W7	686	65	32		
Bar	0.4	0.5	0.6	0.8	1	1.2	1.4	1.6	1.8	2	2.1	2.3	2.4
Psi	6	7	9	12	15	17	20	23	26	29	30	33	35
10 km/h	675	745	815	960	1100	1240	1280	1315	1395	1475	1515	1595	1635
30 km/h	535	605	675	745	815	885	965	1045	1105	1170	1200		
40 km/h			630	695	760	825	900	975	1035	1090	1120		
40 km/h Dual	385	470	555	615	675	740	800	860	910	960	985		
50 km/h			575	640	710	775	830	885	940	995	1020		

Ø inches	Description	CAI	e mm	D mm	R' mm	RC mm	Recommended Rim	Acceptable Rim	Tube (Code)	75% internal volume (litres)	Tread depth (mm)		
24	11.2R24 119A8/116B TL	317247	288	1095	503	3269	W10	W9	692	92	37		
Bar	0.4	0.5	0.6	0.8	1	1.2	1.4	1.6	1.8	2	2.1	2.3	2.4
Psi	6	7	9	12	15	17	20	23	26	29	30	33	35
10 km/h	840	925	1005	1170	1335	1500	1570	1635	1720	1810	1850	1935	1980
30 km/h	660	745	830	910	990	1070	1170	1265	1340	1415	1455		
40 km/h			775	850	925	1000	1090	1180	1250	1325	1360		
40 km/h Dual	480	580	680	750	825	895	970	1040	1100	1165	1195		
50 km/h			705	780	860	935	1005	1075	1140	1205	1240		

Ø inches	Description	CAI	e mm	D mm	R' mm	RC mm	Recommended Rim	Acceptable Rim	Tube (Code)	75% internal volume (litres)	Tread depth (mm)	
24	12.4R24 119A8/116B TL	123788	324	1149	520	3420	W11	W10	692	116	41	
Bar	0.5	0.6	0.8	1	1.2	1.4	1.6	1.8				
Psi	7	9	12	15	17	20	23	26				
10 km/h	1040	1200	1330	1460	1590	1715	1845	1975				
30 km/h	810	950	1050	1155	1255	1360	1460					
40 km/h		880	975	1070	1170	1265	1360					
50 km/h		830	915	1000	1080	1165	1250					

* Refer to the notes at the end of the tables of this range

MICHELIN AGRIBIB

Tire specifications and pressure table (bar & psi). Load per tire in kg*

Ø inches	Description	CAI	e mm	D mm	R' mm	RC mm	Recommended Rim	Acceptable Rim	Tube (Code)	75% internal volume (litres)	Tread depth (mm)			
24	13.6R24 124A8/121B TL	262831	370	1200	551	3583	W12	W11	700	144	43			
Bar	0.4	0.5	0.6	0.8	1	1.2	1.4	1.6	1.8	2	2.1	2.3	2.4	2.6
Psi	6	7	9	12	15	17	20	23	26	29	30	33	35	38
10 km/h	975	1075	1175	1375	1570	1770	1850	1930	2030	2130	2175	2275	2325	
30 km/h	760	865	965	1065	1165	1265	1385	1500	1585	1670	1710			
40 km/h				900	995	1085	1180	1290	1400	1480	1560	1600		
40 km/h Dual	555	675	790	880	965	1055	1140	1230	1300	1375	1410			
40 km/h FRT								1550	1680	1775	1825	1920	1960	2040
50 km/h				820	915	1010	1105	1190	1275	1345	1420	1455		

Ø inches	Description	CAI	e mm	D mm	R' mm	RC mm	Recommended Rim	Acceptable Rim	Tube (Code)	75% internal volume (litres)	Tread depth (mm)			
24	14.9R24 130A8/127B TL	601563	397	1265	575	3769	W13	W11 W12	703	188	48			
Bar	0.4	0.5	0.6	0.8	1	1.2	1.4	1.6	1.8	2	2.1	2.3	2.4	
Psi	6	7	9	12	15	17	20	23	26	29	30	33	35	
10 km/h	1165	1280	1400	1635	1865	2100	2175	2250	2380	2515	2580	2710	2775	
30 km/h	910	1040	1165	1275	1390	1500	1635	1765	1875	1980	2035			
40 km/h				1090	1195	1295	1400	1525	1650	1750	1850	1900		
40 km/h Dual	660	810	960	1060	1155	1255	1350	1450	1540	1625	1670			
50 km/h				990	1100	1210	1320	1410	1500	1590	1685	1730		

Ø inches	Description	CAI	e mm	D mm	R' mm	RC mm	Recommended Rim	Acceptable Rim	Tube (Code)	75% internal volume (litres)	Tread depth (mm)	
24	16.9R24 134A8/131B TL	123854	460	1330	586	3935	DW15L	DW14L W14L W15L	710	244	55	
Bar	0.4	0.5	0.6	0.8	1	1.2	1.4	1.6	1.8			
Psi	6	7	9	12	15	17	20	23	26			
10 km/h		1620	1880	2080	2280	2480	2680	2880	3080			
30 km/h		1270	1470	1630	1790	1950	2110	2270				
40 km/h			1380	1530	1675	1825	1970	2120				
40 km/h Dual	790	1005	1215	1345	1475	1605	1735	1865				
50 km/h			1290	1420	1555	1685	1820	1950				

* Refer to the notes at the end of the tables of this range

MICHELIN AGRIBIB

Tire specifications and pressure table (bar & psi). Load per tire in kg*

Ø inches	Description	CAI	e mm	D mm	R' mm	RC mm	Recommended Rim		Acceptable Rim		Tube (Code)	75% internal volume (litres)	Tread depth (mm)
28	12.4R28 126A8/123B TL	738964	322	1265	586	3778	W11	W10	726	134	40		
Bar	0.4	0.5	0.6	0.8	1	1.2	1.4	1.6	1.8	2	2.1	2.3	2.4
Psi	6	7	9	12	15	17	20	23	26	29	30	33	35
10 km/h	1035	1140	1245	1455	1665	1875	1960	2040	2150	2260	2310	2420	2475
30 km/h	805	925	1045	1145	1240	1340	1475	1605	1690	1775	1820		
40 km/h		975	1065	1160	1250	1375	1500	1580	1660	1700			
40 km/h Dual	590	725	860	950	1045	1135	1230	1320	1390	1460	1495		
50 km/h		885	980	1075	1170	1270	1365	1435	1510	1545			

Ø inches	Description	CAI	e mm	D mm	R' mm	RC mm	Recommended Rim		Acceptable Rim		Tube (Code)	75% internal volume (litres)	Tread depth (mm)
28	13.6R28 123A8/120B TL	123782	372	1308	592	3893	W12	W11	732	173	46		
Bar	0.4	0.5	0.6	0.8	1	1.2	1.4	1.6	1.8				
Psi	6	7	9	12	15	17	20	23	26				
10 km/h		1190	1370	1520	1665	1815	1960	2110	2255				
30 km/h		930	1080	1195	1310	1430	1545	1660					
40 km/h			1010	1120	1225	1335	1440	1550					
40 km/h Dual	590	740	890	985	1080	1175	1270	1365					
50 km/h		920	1015	1110	1210	1305	1400						

Ø inches	Description	CAI	e mm	D mm	R' mm	RC mm	Recommended Rim		Acceptable Rim		Tube (Code)	75% internal volume (litres)	Tread depth (mm)		
28	14.9R28 134A8/131B TL	112235	393	1365	624	4072	W13	W12	821	210	47				
Bar	0.4	0.5	0.6	0.8	1	1.2	1.4	1.6	1.8	2	2.1	2.3	2.4	2.6	2.8
Psi	6	7	9	12	15	17	20	23	26	29	30	33	35	38	41
10 km/h	1240	1365	1495	1745	2000	2250	2365	2475	2625	2775	2825	2925	2980	3080	3180
30 km/h	885	980	1070	1230	1420	1605	1765	1925	2010	2100	2140	2225	2270		
40 km/h			1000	1150	1325	1500	1650	1800	1880	1960	2000	2080	2120		
50 km/h			910	1045	1205	1365	1505	1640	1715	1785	1820	1895	1930		

Ø inches	Description	CAI	e mm	D mm	R' mm	RC mm	Recommended Rim		Acceptable Rim		Tube (Code)	75% internal volume (litres)	Tread depth (mm)		
28	16.9R28 141A8/138B TL	984997	454	1435	655	4278	DW15L	DW14L W14L W15L	822	272	51				
Bar	0.4	0.5	0.6	0.8	1	1.2	1.4	1.6	1.8	2	2.1	2.3	2.4	2.6	2.8
Psi	6	7	9	12	15	17	20	23	26	29	30	33	35	38	41
10 km/h	1500	1650	1800	2100	2400	2700	2850	3000	3180	3360	3425	3550	3615	3740	3865
30 km/h	1070	1185	1300	1500	1715	1925	2130	2335	2440	2545	2600	2705	2755		
40 km/h			1215	1400	1600	1800	1990	2180	2280	2380	2425	2525	2575		
50 km/h			1105	1275	1460	1640	1815	1985	2075	2165	2210	2300	2345		

* Refer to the notes at the end of the tables of this range

MICHELIN AGRIBIB

Tire specifications and pressure table (bar & psi). Load per tire in kg*

Ø inches	Description	CAI	e mm	D mm	R' mm	RC mm	Recommended Rim	Acceptable Rim	Tube (Code)	75% internal volume (litres)	Tread depth (mm)
30	380/85R30 135A8/135B TL	836509	386	1416	628	4194	W12	W13	734	209	46
Bar	0.4	0.5	0.6	0.8	1	1.2	1.4	1.6	1.8		
Psi	6	7	9	12	15	17	20	23	26		
10 km/h	1450	1565	1680	1905	2135	2360	2580	2800	3100		
30 km/h	1060	1155	1250	1450	1675	1900	2100	2300			
40 km/h			1180	1360	1555	1750	1965	2180			
40 km/h Dual	860	950	1040	1195	1370	1540	1730	1920			
50 km/h			1180	1360	1550	1750	1965	2180			

Ø inches	Description	CAI	e mm	D mm	R' mm	RC mm	Recommended Rim	Acceptable Rim	Tube (Code)	75% internal volume (litres)	Tread depth (mm)
30	16.9R30 137A8/134B TL	123870	447	1480	664	4395	DW15L	DW14L W14L W15L	754	285	49
Bar	0.4	0.5	0.6	0.8	1	1.2	1.4	1.6	1.8		
Psi	6	7	9	12	15	17	20	23	26		
10 km/h		1760	2040	2255	2475	2690	2910	3125	3340		
30 km/h		1380	1600	1770	1945	2115	2290	2460			
40 km/h			1500	1660	1820	1980	2140	2300			
40 km/h Dual	880	1100	1320	1460	1600	1745	1885	2025			
50 km/h			1400	1545	1690	1830	1975	2120			

Ø inches	Description	CAI	e mm	D mm	R' mm	RC mm	Recommended Rim	Acceptable Rim	Tube (Code)	75% internal volume (litres)	Tread depth (mm)				
30	420/90R30 147A8/147B TL	953332	443	1533	690	4556	DW13	W13 DW14L W14L	754	284	44				
Bar	0.4	0.5	0.6	0.8	1	1.2	1.4	1.6	1.8	2	2.1	2.3	2.4	2.6	2.8
Psi	6	7	9	12	15	17	20	23	26	29	30	33	35	38	41
10 km/h	1800	1955	2110	2415	2725	3035	3340	3650	3950	4250	4315	4440	4500	4565	4625
30 km/h	1285	1420	1550	1800	2050	2300	2550	2800	2940	3075	3145	3280	3350		
40 km/h			1450	1700	1940	2175	2415	2650	2775	2900	2945	3030	3075		
40 km/h Dual	1070	1175	1275	1495	1705	1915	2120	2330	2440	2550	2590	2665	2705		
50 km/h			1450	1700	1940	2175	2415	2650	2775	2900	2945	3030	3075		

* Refer to the notes at the end of the tables of this range

MICHELIN AGRIBIB

Tire specifications and pressure table (bar & psi). Load per tire in kg*

Ø inches	Description	CAI	e mm	D mm	R' mm	RC mm	Recommended Rim	Acceptable Rim	Tube (Code)	75% internal volume (litres)	Tread depth (mm)
30	18.4R30 142A8/139B TL	123844	504	1550	695	4602	DW16L	DW15L W15L W16L	757	353	54
Bar	0.4	0.5	0.6	0.8	1	1.2	1.4	1.6	1.8		
Psi	6	7	9	12	15	17	20	23	26		
10 km/h		2030	2350	2600	2850	3100	3355	3605	3855		
30 km/h		1590	1840	2040	2240	2440	2640	2840			
40 km/h			1720	1905	2090	2280	2465	2650			
40 km/h Dual	1040	1280	1515	1680	1840	2005	2165	2330			
50 km/h		1600	1765	1930	2100	2265	2430				

Ø inches	Description	CAI	e mm	D mm	R' mm	RC mm	Recommended Rim	Acceptable Rim	Tube (Code)	75% internal volume (litres)	Tread depth (mm)				
34	320/85R34 133A8/130B TL	122760	320	1420	651	4239	W10			155	39				
Bar	0.4	0.5	0.6	0.8	1	1.2	1.4	1.6	1.8	2	2.1	2.3	2.4	2.6	2.8
Psi	6	7	9	12	15	17	20	23	26	29	30	33	35	38	41
10 km/h	1215	1315	1410	1610	1805	2000	2215	2430	2615	2800	2835	2905	2940	3005	3075
30 km/h	850	940	1030	1215	1385	1550	1725	1900	1980	2060	2090	2150	2180		
40 km/h			975	1120	1285	1450	1600	1750	1850	1950	1980	2035	2060		
40 km/h Dual	705	785	860	985	1130	1275	1410	1540	1630	1715	1740	1790	1815		
50 km/h			900	1030	1180	1320	1460	1600	1700	1800	1825	1875	1900		

Ø inches	Description	CAI	e mm	D mm	R' mm	RC mm	Recommended Rim	Acceptable Rim	Tube (Code)	75% internal volume (litres)	Tread depth (mm)
34	380/85R34 137A8/137B TL	122781	394	1503	673	4461	W12	W13	704	230	44
Bar	0.4	0.5	0.6	0.8	1	1.2	1.4	1.6	1.8		
Psi	6	7	9	12	15	17	20	23	26		
10 km/h	1550	1670	1790	2025	2265	2500	2750	3000	3300		
30 km/h	1120	1220	1320	1550	1775	2000	2215	2430			
40 km/h			1250	1450	1650	1850	2075	2300			
40 km/h Dual	905	1005	1100	1275	1455	1630	1830	2025			
50 km/h			1250	1450	1650	1850	2075	2300			

* Refer to the notes at the end of the tables of this range

MICHELIN AGRIBIB

Tire specifications and pressure table (bar & psi). Load per tire in kg*

Ø inches	Description	CAI	e mm	D mm	R' mm	RC mm	Recommended Rim	Acceptable Rim	Tube (Code)	75% internal volume (litres)	Tread depth (mm)				
34	420/85R34 147A8/147B TL	788910	455	1595	725	4751	DW15L	W13 DW14L W14L W15L	704	287	51				
Bar	0.4	0.5	0.6	0.8	1	1.2	1.4	1.6	1.8	2	2.1	2.3	2.4	2.6	2.8
Psi	6	7	9	12	15	17	20	23	26	29	30	33	35	38	41
10 km/h	1800	1940	2075	2350	2625	2900	3175	3450	3800	4045	4115	4260	4330	4475	4615
30 km/h	1300	1430	1560	1815	2075	2330	2585	2835	2950	3065	3120	3235	3290		
40 km/h			1450	1695	1935	2180	2415	2650	2755	2865	2915	3020	3075		
40 km/h Dual			1280	1495	1705	1920	2125	2330	2425	2520	2570	2665	2710		
50 km/h			1450	1695	1935	2180	2415	2650	2755	2865	2915	3020	3075		

Ø inches	Description	CAI	e mm	D mm	R' mm	RC mm	Recommended Rim	Acceptable Rim	Tube (Code)	75% internal volume (litres)	Tread depth (mm)				
34	18.4R34 149A8/146B TL	679786	491	1662	747	4940	DW16L	DW15L W15L W16L	823	395	54				
Bar	0.4	0.5	0.6	0.8	1	1.2	1.4	1.6	1.8	2	2.1	2.3	2.4		
Psi	6	7	9	12	15	17	20	23	26	29	30	33	35		
10 km/h	1980	2175	2370	2760	3150	3540	3705	3865	4080	4295	4405	4620	4725		
30 km/h	1550	1765	1980	2160	2345	2525	2760	2995	3190	3385	3480				
40 km/h			1850	2020	2190	2360	2580	2800	2980	3160	3250				
40 km/h Dual	1130	1380	1630	1795	1965	2130	2300	2465	2625	2780	2860				
50 km/h			1685	1860	2035	2210	2380	2550	2715	2880	2960				

Ø inches	Description	CAI	e mm	D mm	R' mm	RC mm	Recommended Rim	Acceptable Rim	Tube (Code)	75% internal volume (litres)	Tread depth (mm)
36	12.4R36 124A8/121B TL	123952	318	1460	673	4363	W11	W10	779	165	33
Bar	0.5	0.6	0.8	1	1.2	1.4	1.6	1.8			
Psi	7	9	12	15	17	20	23	26			
10 km/h	1220	1420	1570	1720	1870	2025	2175	2325			
30 km/h	960	1110	1230	1350	1470	1590	1710				
40 km/h		1040	1150	1265	1375	1490	1600				
50 km/h		960	1060	1155	1255	1350	1450				

* Refer to the notes at the end of the tables of this range

MICHELIN AGRIBIB

Tire specifications and pressure table (bar & psi). Load per tire in kg*

Ø inches	Description	CAI	e mm	D mm	R' mm	RC mm	Recommended Rim	Acceptable Rim	Tube (Code)	75% internal volume (litres)	Tread depth (mm)		
38	12.4R38 131A8/128B TL	258138	325	1500	697	4484	W11	DW10 W10	779	165	35		
Bar	0.4	0.5	0.6	0.8	1	1.2	1.4	1.6	1.8	2	2.1	2.3	2.4
Psi	6	7	9	12	15	17	20	23	26	29	30	33	35
10 km/h	1200	1315	1425	1650	1875	2100	2215	2325	2440	2550	2605	2720	2775
30 km/h	935	1070	1200	1300	1400	1500	1660	1820	1925	2030	2085		
40 km/h		1120	1215	1305	1400	1500	1550	1700	1800	1900	1950		
40 km/h Dual	680	835	985	1085	1190	1290	1395	1495	1585	1670	1715		
50 km/h			1020	1120	1220	1320	1435	1545	1635	1730	1775		

Ø inches	Description	CAI	e mm	D mm	R' mm	RC mm	Recommended Rim	Acceptable Rim	Tube (Code)	75% internal volume (litres)	Tread depth (mm)		
38	13.6R38 128A8/125B TL	123992	358	1565	722	4705	DW12	W11 W12	795	218	45		
Bar	0.4	0.5	0.6	0.8	1	1.2	1.4	1.6	1.8				
Psi	6	7	9	12	15	17	20	23	26				
10 km/h		1380	1590	1760	1930	2100	2275	2445	2615				
30 km/h		1080	1250	1385	1520	1660	1795	1930					
40 km/h			1030	1140	1250	1365	1475	1585					
40 km/h Dual	685	860	1030	1140	1250	1365	1475	1585					
50 km/h			1090	1200	1315	1425	1540	1650					

Ø inches	Description	CAI	e mm	D mm	R' mm	RC mm	Recommended Rim	Acceptable Rim	Tube (Code)	75% internal volume (litres)	Tread depth (mm)		
38	420/85R38 144A8/144B TL	607820	455	1676	750	4975	DW15L	DW14L W14L W15L	786	311	51		
Bar	0.4	0.5	0.6	0.8	1	1.2	1.4	1.6	1.8				
Psi	6	7	9	12	15	17	20	23	26				
10 km/h	1900	2045	2190	2485	2775	3065	3360	3650	4015				
30 km/h	1375	1510	1645	1915	2190	2460	2730	3000					
40 km/h			1550	1800	2050	2300	2550	2800					
40 km/h Dual	1130	1240	1355	1575	1800	2020	2245	2465					
50 km/h			1550	1800	2050	2300	2550	2800					
max 40 km/h FRT				2160	2460	2760	3060	3360					

* Refer to the notes at the end of the tables of this range

MICHELIN AGRIBIB

Tire specifications and pressure table (bar & psi). Load per tire in kg*

Ø inches	Description	CAI	e mm	D mm	R' mm	RC mm	Recommended Rim		Acceptable Rim		Tube (Code)	75% internal volume (litres)	Tread depth (mm)		
38	380/95R38 147A8/147B TL	836033	392	1689	769	5034	W12		W13		795	286	47		
Bar	0.4	0.5	0.6	0.8	1	1.2	1.4	1.6	1.8	2	2.1	2.3	2.4	2.6	2.8
Psi	6	7	9	12	15	17	20	23	26	29	30	33	35	38	41
10 km/h	1825	1980	2130	2440	2745	3055	3360	3670	3975	4100	4165	4295	4355	4485	4610
30 km/h	1300	1430	1555	1810	2070	2325	2580	2835	2950	3065	3120	3235	3290		
40 km/h			1450	1690	1930	2170	2410	2650	2755	2865	2915	3020	3075		
40 km/h Dual	1070	1150	1235	1395	1560	1725	1890	2050	2215	2380	2460	2625	2705		
50 km/h			1450	1690	1930	2170	2410	2650	2755	2865	2915	3020	3075		

Ø inches	Description	CAI	e mm	D mm	R' mm	RC mm	Recommended Rim		Acceptable Rim		Tube (Code)	75% internal volume (litres)	Tread depth (mm)		
38	18.4R38 151A8/148B TL	100097	494	1770	800	5267	DW16L		DW15L W15L W16L		824	431	54		
Bar	0.4	0.5	0.6	0.8	1	1.2	1.4	1.6	1.8	2	2.1	2.3	2.4		
Psi	6	7	9	12	15	17	20	23	26	29	30	33	35		
10 km/h	2100	2305	2515	2925	3340	3750	3920	4090	4325	4560	4675	4910	5025		
30 km/h	1660	1875	2085	2280	2480	2675	2945	3210	3400	3595	3690				
40 km/h			1950	2135	2315	2500	2750	3000	3180	3360	3450				
40 km/h Dual	1195	1455	1715	1900	2085	2270	2455	2640	2800	2955	3035				
50 km/h			1775	1965	2155	2345	2540	2730	2895	3060	3140				

Ø inches	Description	CAI	e mm	D mm	R' mm	RC mm	Recommended Rim		Acceptable Rim		Tube (Code)	75% internal volume (litres)	Tread depth (mm)		
38	20.8R38 159A8/156B TL	813266	541	1850	837	5506	DW18L		DW16L W16L W18L		825	524	57		
Bar	0.4	0.5	0.6	0.8	1	1.2	1.4	1.6	1.8	2	2.1	2.3	2.4	2.6	2.8
Psi	6	7	9	12	15	17	20	23	26	29	30	33	35	38	41
10 km/h	2550	2810	3065	3585	4100	4615	4895	5175	5495	5815	5910	6095	6190	6380	6565
30 km/h	1820	2015	2205	2525	2910	3290	3655	4015	4180	4350	4430	4595	4680		
40 km/h			2060	2360	2720	3075	3415	3750	3905	4065	4140	4295	4375		
40 km/h Dual			1810	2075	2390	2705	3005	3300	3440	3575	3645	3780	3850		
50 km/h			1875	2150	2475	2800	3110	3415	3555	3700	3770	3910	3980		

* Refer to the notes at the end of the tables of this range

MICHELIN AGRIBIB

Tire specifications and pressure table (bar & psi). Load per tire in kg*

Ø inches	Description	CAI	e mm	D mm	R' mm	RC mm	Recommended Rim	Acceptable Rim	Tube (Code)	75% internal volume (litres)	Tread depth (mm)
38	520/85R38 155A8/155B TL	303668	530	1855	821	5529	DW16L	DD16 DW16A W16A DD18 W18A	825	509	51
Bar	0.4	0.5	0.6	0.8	1	1.2	1.4	1.6	1.8		
Psi	6	7	9	12	15	17	20	23	26		
10 km/h	2650	2850	3050	3450	3850	4250	4625	5000	5535		
30 km/h	1900	2100	2300	2650	3050	3450	3790	4125			
40 km/h			2120	2500	2825	3150	3515	3875			
40 km/h Dual	1540	1705	1865	2200	2485	2770	3090	3410			
50 km/h			2120	2500	2800	3160	3515	3875			
max 40 km/h FRT				3000	3415	3825	4240	4650			

Ø inches	Description	CAI	e mm	D mm	R' mm	RC mm	Recommended Rim	Acceptable Rim	Tube (Code)	75% internal volume (litres)	Tread depth (mm)				
42	480/80R42 156A8/156B TL	404096	494	1858	847	5538	DW16A	DD16 W16A	801	420	55				
Bar	0.4	0.5	0.6	0.8	1	1.2	1.4	1.6	1.8	2	2.1	2.3	2.4	2.6	2.8
Psi	6	7	9	12	15	17	20	23	26	29	30	33	35	38	41
10 km/h	2325	2505	2690	3050	3415	3775	4140	4500	4750	5000	5125	5375	5500	5750	6000
30 km/h	1660	1830	2000	2335	2675	3015	3350	3690	3840	3985	4060	4205	4280		
40 km/h			1850	2170	2490	2810	3130	3450	3590	3725	3795	3930	4000		
40 km/h Dual	1320	1465	1605	1890	2180	2465	2750	3035	3155	3280	3340	3460	3520		
50 km/h			1850	2170	2490	2810	3130	3450	3590	3725	3795	3930	4000		
max 40 km/h FRT				2600	2955	3315	3670	4030	4385	4455	4595	4660	4800		

Ø inches	Description	CAI	e mm	D mm	R' mm	RC mm	Recommended Rim	Acceptable Rim	Tube (Code)	75% internal volume (litres)	Tread depth (mm)
42	520/85R42 157A8/157B TL	122791	539	1945	869	5771	DW18A	DD18 W18A	802	545	59
Bar	0.4	0.5	0.6	0.8	1	1.2	1.4	1.6	1.8		
Psi	6	7	9	12	15	17	20	23	26		
10 km/h	2800	3015	3225	3650	4075	4500	4900	5300	5865		
30 km/h	2000	2180	2360	2800	3175	3550	3965	4375			
40 km/h			2240	2575	2965	3350	3740	4125			
40 km/h Dual	1630	1800	1970	2265	2610	2950	3290	3630			
50 km/h			2240	2575	3000	3350	3740	4125			
max 40 km/h FRT				3090	3555	4020	4485	4950			

* Refer to the notes at the end of the tables of this range

MICHELIN AGRIBIB

Tire specifications and pressure table (bar & psi). Load per tire in kg*

Ø inches	Description	CAI	e mm	D mm	R' mm	RC mm	Recommended Rim	Acceptable Rim	Tube (Code)	75% internal volume (litres)	Tread depth (mm)				
46	420/80R46 151A8/148B TL	122770	410	1872	861	5555	DW13	DW12	835	334	51				
Bar	0.4	0.5	0.6	0.8	1	1.2	1.4	1.6	1.8	2	2.1	2.3	2.4	2.6	2.8
Psi	6	7	9	12	15	17	20	23	26	29	30	33	35	38	41
10 km/h	2000	2170	2340	2675	3015	3350	3675	4000	4315	4625	4720	4905	5000	5075	5150
30 km/h	1450	1575	1700	2000	2290	2575	2865	3150	3300	3450	3500	3600	3650		
40 km/h			1600	1850	2140	2430	2665	2900	3075	3250	3300	3400	3450		
40 km/h Dual	1160	1285	1410	1630	1885	2140	2345	2550	2705	2860	2905	2990	3035		
50 km/h			1450	1700	1950	2240	2445	2650	2800	3000	3040	3115	3150		

Ø inches	Description	CAI	e mm	D mm	R' mm	RC mm	Recommended Rim	Acceptable Rim	Tube (Code)	75% internal volume (litres)	Tread depth (mm)				
46	480/80R46 158A8/158B TL	637231	499	1948	889	5874	DW16A	DD16 DW16L W16A	834	449	54				
Bar	0.4	0.5	0.6	0.8	1	1.2	1.4	1.6	1.8	2	2.1	2.3	2.4	2.6	2.8
Psi	6	7	9	12	15	17	20	23	26	29	30	33	35	38	41
10 km/h	2475	2675	2875	3275	3675	4075	4475	4875	5125	5375	5500	5755	5880	6130	6380
30 km/h	1770	1940	2110	2445	2785	3125	3460	3800	3990	4175	4270	4455	4550		
40 km/h			1950	2270	2590	2910	3230	3550	3725	3900	3990	4165	4250		
40 km/h Dual	1450	1585	1715	1940	2165	2390	2615	2840	3065	3290	3405	3630	3740		
50 km/h			1950	2270	2590	2910	3230	3550	3725	3900	3990	4165	4250		
max 40 km/h FRT					2725	3095	3465	3830	4200	4570	4660	4835	4925	5100	

Ø inches	Description	CAI	e mm	D mm	R' mm	RC mm	Recommended Rim	Acceptable Rim	Tube (Code)	75% internal volume (litres)	Tread depth (mm)				
46	520/85R46 158A8/155B TL	122780	515	2050	920	6088	DW16A	DW16L W16A DW18L W18L W16L W18A DW18A	834	581	58				
Bar	0.4	0.5	0.6	0.8	1	1.2	1.4	1.6	1.8						
Psi	6	7	9	12	15	17	20	23	26						
10 km/h	2900	3115	3325	3750	4175	4600	5025	5450	6070						
30 km/h	2090	2295	2500	2910	3320	3730	4140	4550							
40 km/h			2300	2690	3080	3470	3860	4250							
40 km/h Dual	1715	1885	2055	2390	2730	3065	3400	3740							
50 km/h			2120	2470	2820	3175	3525	3875							
max 40 km/h FRT					3230	3700	4165	4635	5100						

* Refer to the notes at the end of the tables of this range

MICHELIN AGRIBIB

Tire specifications and pressure table (bar & psi). Load per tire in kg*

Ø inches	Description	CAI	e mm	D mm	R' mm	RC mm	Recommended Rim	Acceptable Rim	Tube (Code)	75% internal volume (litres)	Tread depth (mm)				
50	480/80R50 159A8/159B TL	471947	474	2056	942	6135	DW15A	DW16A		479	56				
Bar	0.4 0.5 0.6 0.8 1 1.2 1.4 1.6 1.8	2 2.1 2.3 2.4 2.6 2.8													
Psi	6 7 9 12 15 17 20 23 26	29 30 33 35 38 41													
10 km/h	2575	2785	2995	3415	3830	4250	4700	5150	5575	6000	6075	6225	6300	6400	6500
30 km/h	1800	1990	2180	2575	2915	3250	3625	4000	4190	4375	4440	4565	4625		
40 km/h			2060	2360	2720	3075	3415	3750	3940	4125	4190	4315	4375		
40 km/h Dual	1495	1655	1815	2075	2390	2705	3005	3300	3465	3630	3685	3795	3850		
50 km/h			2060	2360	2725	3075	3415	3750	3875	4125	4190	4315	4375		
max 40 km/h FRT				2830	3230	3635	4035	4440	4840	4910	5045	5115	5250		

Ø inches	Description	CAI	e mm	D mm	R' mm	RC mm	Recommended Rim	Acceptable Rim	Tube (Code)	75% internal volume (litres)	Tread depth (mm)				
50	480/95R50 164A8/164B TL	491183	515	2175	992	6484	DW16B (A)	DW15B (A)		593	53				
Bar	0.4 0.5 0.6 0.8 1 1.2 1.4 1.6 1.8	2 2.1 2.3 2.4 2.6 2.8													
Psi	6 7 9 12 15 17 20 23 26	29 30 33 35 38 41													
10 km/h	2925	3100	3270	3780	4285	4795	5300	5810	6185	6560	6750	7125	7310	7405	7500
30 km/h	2085	2305	2525	2955	3385	3820	4250	4680	4850	5015	5100	5265	5350		
40 km/h			2360	2765	3165	3570	3970	4375	4530	4690	4765	4920	5000		
40 km/h Dual	1720	1900	2080	2435	2790	3140	3495	3850	3990	4125	4195	4330	4400		
50 km/h			2360	2765	3165	3570	3970	4375	4530	4690	4765	4920	5000		
max 40 km/h FRT				3320	3760	4205	4645	5090	5530	5610	5765	5845	6000		

***IMPORTANT:**

The inflation pressure must always be appropriate for the load per tire, the speed of travel and the work to be done. Our recommendations above are provided subject to changes made after the date of publication of these tables (July 2020). Technical data is subject to change without prior notice.

- For plowing and other field applications subject to high torque, use the 30 km/h column.
- When using single tire configuration:
 - add 0.4 bar for use on slopes of more than 20%
 - add 0.4 bar for intense road use exceeding 50% of time on road
- 10 km/h LT (Low Torque) (max speed 10 km/h).
- FRT: Free Rolling Tire

HARVESTERS & FLOATERS



MICHELIN CEREXBIB 2

**HIGH PRODUCTIVITY
& OUTSTANDING SOIL
PROTECTION**



FOR **HARVESTING MACHINES**



CFO+ rated tire

- Carry more load at 10 km/h cyclic in the field
- -45% pressure vs non CFO+ radial tire in the same size ⁽¹⁾



BETTER YIELDS

- Potential increase in yields of up to 4% year ⁽²⁾



SOIL PROTECTION

- Low pressure in the fields



TRACTION & FLOTATION



STEEL REINFORCED TREAD

- Great stability
- Excellent puncture resistance and better load distribution.

(1) For 12 000 kg, compared to a 900/60R32 Michelin Megaxbib standard radial (2) Harper Adams University 2014/2016

SIZES

VF 520/80R26 CFO+ 168A8 TL
VF 620/70R26 CFO+ 173A8 TL
VF 750/65R26 CFO+ 180A8 TL
VF 620/70R30 CFO+ 175A8 TL
VF 520/85R30 CFO+ 172A8 TL
VF 710/65R30 CFO+ 179A8 TL

IF 800/65R32 CFO+ 181A8 TL
VF 900/60R32 CFO+ 191A8 TL
IF 800/70R32 CFO+ 185A8 TL
VF 500/85R34 CFO+ 172A8 TL
IF 680/80R38 CFO+ 182A8 TL
VF 900/60R38 CFO+ 193A8 TL

IF 800/70R38 CFO+ 187A8 TL
VF 520/85R42 CFO+ 177A8 TL
VF 580/85R42 CFO+ 183A8 TL
VF 710/70R42 CFO+ 188A8 TL
VF 900/60R42 CFO+ 195A8 TL
IF 800/70R42 CFO+ 189A8 TL

MICHELIN CEREXBIB 2

Tire specifications and pressure table (bar & psi). Load per tire in kg*

Ø inches	Description	CAI	e mm	D mm	R' mm	RC mm	Recommended Rim	Acceptable Rim	Tube (Code)	75% internal volume (litres)	Tread depth (mm)				
26	VF 520/80R26 CFO+ 168A8 TL	850494	503	1491	649	4400	DW16L	W16L DW18L	716	366	44				
Bar	1.2	1.4	1.6	1.7	1.8	1.9	2	2.1	2.2	2.3	2.4	2.5	2.6	2.7	2.8
Psi	17	20	23	25	26	28	29	30	32	33	35	36	38	39	41
10 km/h Cyc	5230	5805	6375	6510	6645	6775	6910	7045	7175	7310	7440	7600	7760	7915	8075
15 km/h Cyc	4765	5290	5815	5935	6060	6180	6300	6420	6540	6660	6780	6925	7075	7220	7365
40 km/h	3550	3965	4375	4470	4570	4665	4760	4860	4955	5055	5150	5265	5375	5490	5600

Ø inches	Description	CAI	e mm	D mm	R' mm	RC mm	Recommended Rim	Acceptable Rim	Tube (Code)	75% internal volume (litres)	Tread depth (mm)				
26	VF 620/70R26 CFO+ 173A8 TL	228272	606	1513	655	4461	DW20B (A)		716	463	45				
Bar	1.2	1.4	1.6	1.7	1.8	1.9	2	2.1	2.2	2.3	2.4	2.5	2.6	2.7	2.8
Psi	17	20	23	25	26	28	29	30	32	33	35	36	38	39	41
10 km/h Cyc	6035	6740	7440	7605	7770	7935	8100	8265	8430	8590	8755	8945	9140	9330	9520
15 km/h Cyc	5505	6145	6780	6930	7080	7230	7380	7530	7685	7835	7985	8160	8335	8505	8680
40 km/h	4125	4640	5150	5255	5365	5470	5575	5680	5790	5895	6000	6125	6250	6375	6500

Ø inches	Description	CAI	e mm	D mm	R' mm	RC mm	Recommended Rim	Acceptable Rim	Tube (Code)	75% internal volume (litres)	Tread depth (mm)				
26	VF 750/65R26 CFO+ 180A8 TL	132266	748	1623	701	4786	DW25B (A)		833	659	48				
Bar	1.2	1.4	1.6	1.7	1.8	1.9	2	2.1	2.2	2.3	2.4	2.5	2.6	2.7	2.8
Psi	17	20	23	25	26	28	29	30	32	33	35	36	38	39	41
10 km/h Cyc	7440	8225	9010	9225	9435	9650	9860	10075	10285	10500	10710	10965	11220	11475	11730
15 km/h Cyc	6780	7500	8215	8410	8605	8795	8990	9185	9380	9570	9765	10000	10230	10465	10695
40 km/h	5150	5650	6150	6295	6440	6580	6725	6870	7015	7155	7300	7475	7650	7825	8000

Ø inches	Description	CAI	e mm	D mm	R' mm	RC mm	Recommended Rim	Acceptable Rim	Tube (Code)	75% internal volume (litres)	Tread depth (mm)				
30	VF 620/70R30 CFO+ 175A8 TL	049288	608	1615	700	4765	DW20B (A)		737	506	43				
Bar	1.2	1.4	1.6	1.7	1.8	1.9	2	2.1	2.2	2.3	2.4	2.5	2.6	2.7	2.8
Psi	17	20	23	25	26	28	29	30	32	33	35	36	38	39	41
10 km/h Cyc	6375	7120	7865	8040	8215	8390	8565	8740	8915	9090	9265	9500	9735	9965	10200
15 km/h Cyc	5815	6495	7170	7330	7490	7650	7810	7970	8130	8290	8450	8665	8875	9090	9300
40 km/h	4500	4975	5450	5555	5665	5770	5875	5980	6090	6195	6300	6450	6600	6750	6900

* Refer to the notes at the end of the tables of this range

MICHELIN CEREXBIB 2

Tire specifications and pressure table (bar & psi). Load per tire in kg*

Ø inches	Description	CAI	e mm	D mm	R' mm	RC mm	Recommended Rim	Acceptable Rim	Tube (Code)	75% internal volume (litres)	Tread depth (mm)				
30	VF 520/85R30 CFO+ 172A8 TL	188276	522	1624	709	4797	W16L		737	435	46				
Bar	1.2	1.4	1.6	1.7	1.8	1.9	2	2.1	2.2	2.3	2.4	2.5	2.6	2.7	2.8
Psi	17	20	23	25	26	28	29	30	32	33	35	36	38	39	41
10 km/h Cyc	5865	6545	7225	7360	7495	7625	7760	7895	8025	8160	8290	8535	8780	9020	9265
15 km/h Cyc	5350	5970	6590	6710	6830	6950	7070	7190	7315	7435	7555	7780	8005	8225	8450
40 km/h	4000	4440	4875	4990	5110	5225	5340	5455	5570	5685	5800	5925	6050	6175	6300

Ø inches	Description	CAI	e mm	D mm	R' mm	RC mm	Recommended Rim	Acceptable Rim	Tube (Code)	75% internal volume (litres)	Tread depth (mm)				
30	VF 710/65R30 CFO+ 179A8 TL	608814	693.9	1676	735	4952	DW25B (A)	DW23B (A)		630	46				
Bar	1.2	1.4	1.6	1.7	1.8	1.9	2	2.1	2.2	2.3	2.4	2.5	2.6	2.7	2.8
Psi	17	20	23	25	26	28	29	30	32	33	35	36	38	39	41
10 km/h Cyc	7225	7990	8755	8970	9180	9395	9605	9820	10030	10245	10455	10690	10925	11155	11390
15 km/h Cyc	6590	7290	7985	8180	8375	8565	8760	8955	9150	9340	9535	9750	9960	10175	10385
40 km/h	5000	5500	6000	6140	6275	6415	6550	6690	6825	6965	7100	7265	7425	7590	7750

Ø inches	Description	CAI	e mm	D mm	R' mm	RC mm	Recommended Rim	Acceptable Rim	Tube (Code)	75% internal volume (litres)	Tread depth (mm)				
32	IF 800/65R32 CFO+ 181A8 TL	987406	772	1855	826	5501	DW27B (A)		831	903	57				
Bar	1.2	1.4	1.6	1.7	1.8	1.9	2	2.1	2.2	2.3	2.4	2.5	2.6	2.7	2.8
Psi	17	20	23	25	26	28	29	30	32	33	35	36	38	39	41
10 km/h Cyc	9010	9860	10710	10965	11220	11475	11730	11985	12240	12495	12750	13070	13390	13705	14025
15 km/h Cyc	8215	8990	9765	10000	10230	10465	10695	10930	11160	11395	11625	11915	12210	12500	12790
40 km/h	5300	5800	6300	6450	6600	6750	6900	7050	7200	7350	7500	7690	7875	8065	8250

Ø inches	Description	CAI	e mm	D mm	R' mm	RC mm	Recommended Rim	Acceptable Rim	Tube (Code)	75% internal volume (litres)	Tread depth (mm)				
32	VF 900/60R32 CFO+ 191A8 TL	430737	893	1903	827	5618	DW30B (A)	DW27B (A)		1033	58				
Bar	1.2	1.4	1.6	1.7	1.8	1.9	2	2.1	2.2	2.3	2.4	2.5	2.6	2.7	2.8
Psi	17	20	23	25	26	28	29	30	32	33	35	36	38	39	41
10 km/h Cyc	9860	10965	12070	12370	12665	12965	13260	13560	13855	14155	14450	14770	15090	15405	15725
15 km/h Cyc	8990	10000	11005	11275	11550	11820	12090	12360	12635	12905	13175	13465	13760	14050	14340
40 km/h	6700	7475	8250	8470	8690	8905	9125	9345	9565	9780	10000	10225	10450	10675	10900

* Refer to the notes at the end of the tables of this range

MICHELIN CEREXBIB 2

Tire specifications and pressure table (bar & psi). Load per tire in kg*

Ø inches	Description	CAI	e mm	D mm	R' mm	RC mm	Recommended Rim	Acceptable Rim	Tube (Code)	75% internal volume (litres)	Tread depth (mm)
32	IF 800/70R32 CFO+ 185A8 TL	789156	796	1950	864	5800	DW27B (A)		831	966	55
Bar	1.2 1.4 1.6 1.7 1.8 1.9 2 2.1 2.2 2.3 2.4 2.5 2.6 2.7 2.8										
Psi	17 20 23 25 26 28 29 30 32 33 35 36 38 39 41										
10 km/h Cyc	9860 10965 12070 12370 12665 12965 13260 13560 13855 14155 14450 14770 15090 15405 15725										
15 km/h Cyc	8990 10000 11005 11275 11550 11820 12090 12360 12635 12905 13175 13465 13760 14050 14340										
40 km/h	5800 6450 7100 7275 7450 7625 7800 7975 8150 8325 8500 8690 8875 9065 9250										

Ø inches	Description	CAI	e mm	D mm	R' mm	RC mm	Recommended Rim	Acceptable Rim	Tube (Code)	75% internal volume (litres)	Tread depth (mm)
34	VF 500/85R34 CFO+ 172A8 TL	038009	497	1676	741	4961	DW16L	DW18L		431	46
Bar	1.2 1.4 1.6 1.7 1.8 1.9 2 2.1 2.2 2.3 2.4 2.5 2.6 2.7 2.8										
Psi	17 20 23 25 26 28 29 30 32 33 35 36 38 39 41										
10 km/h Cyc	5870 6445 7020 7180 7340 7495 7655 7815 7975 8130 8290 8470 8650 8830 9010										
15 km/h Cyc	5350 5875 6400 6545 6690 6835 6980 7125 7270 7415 7560 7725 7890 8055 8220										
40 km/h	4000 4440 4875 4965 5060 5150 5240 5330 5420 5510 5600 5775 5950 6125 6300										

Ø inches	Description	CAI	e mm	D mm	R' mm	RC mm	Recommended Rim	Acceptable Rim	Tube (Code)	75% internal volume (litres)	Tread depth (mm)
38	IF 680/80R38 CFO+ 182A8 TL	953912	646	2020	904	6030	DW21B	DW23B (A)	804	877	59
Bar	1.2 1.4 1.6 1.7 1.8 1.9 2 2.1 2.2 2.3 2.4 2.5 2.6 2.7 2.8										
Psi	17 20 23 25 26 28 29 30 32 33 35 36 38 39 41										
10 km/h Cyc	9265 10330 11390 11615 11835 12060 12285 12505 12730 12950 13175 13495 13815 14130 14450										
15 km/h Cyc	8450 9420 10385 10590 10795 10995 11200 11405 11610 11810 12015 12305 12595 12885 13175										
30 km/h Cyc	7085 7900 8710 8880 9050 9220 9395 9565 9735 9905 10075 10320 10565 10805 11050										
40 km/h	5450 6075 6700 6830 6965 7095 7225 7355 7490 7620 7750 7940 8125 8315 8500										

Ø inches	Description	CAI	e mm	D mm	R' mm	RC mm	Recommended Rim	Acceptable Rim	Tube (Code)	75% internal volume (litres)	Tread depth (mm)
38	VF 900/60R38 CFO+ 193A8 TL	439024	879	2029	889	5993	DW30B (A)	DW27B (A)		1149	58
Bar	1.2 1.4 1.6 1.7 1.8 1.9 2 2.1 2.2 2.3 2.4 2.5 2.6 2.7 2.8										
Psi	17 20 23 25 26 28 29 30 32 33 35 36 38 39 41										
10 km/h Cyc	10455 11605 12750 13070 13390 13705 14025 14345 14665 14980 15300 15725 16150 16575 17000										
15 km/h Cyc	9765 10885 12000 12245 12490 12730 12975 13220 13465 13705 13950 14350 14750 15150 15550										
40 km/h	7300 8025 8750 8980 9215 9445 9675 9905 10140 10370 10600 10825 11050 11275 11500										

* Refer to the notes at the end of the tables of this range

MICHELIN CEREXBIB 2

Tire specifications and pressure table (bar & psi). Load per tire in kg*

Ø inches	Description	CAI	e mm	D mm	R' mm	RC mm	Recommended Rim	Acceptable Rim	Tube (Code)	75% internal volume (litres)	Tread depth (mm)				
38	IF 800/70R38 CFO+ 187A8 TL	610997	790	2051	912	6079	DW27B (A)		804	1088	57				
Bar	1.2	1.4	1.6	1.7	1.8	1.9	2	2.1	2.2	2.3	2.4	2.5	2.6	2.7	2.8
Psi	17	20	23	25	26	28	29	30	32	33	35	36	38	39	41
10 km/h Cyc	10710	11945	13175	13440	13705	13970	14240	14505	14770	15035	15300	15620	15940	16255	16575
15 km/h Cyc	9765	10885	12000	12245	12490	12730	12975	13220	13465	13705	13950	14240	14530	14820	15110
40 km/h	6300	7025	7750	7905	8065	8220	8375	8530	8690	8845	9000	9190	9375	9565	9750

Ø inches	Description	CAI	e mm	D mm	R' mm	RC mm	Recommended Rim	Acceptable Rim	Tube (Code)	75% internal volume (litres)	Tread depth (mm)				
42	VF 520/85R42 CFO+ 177A8 TL	270459	541	1953	881	5807	DW18B(A)	DD18 W18L	802	545	55				
Bar	1.2	1.4	1.6	1.7	1.8	1.9	2	2.1	2.2	2.3	2.4	2.5	2.6	2.7	2.8
Psi	17	20	23	25	26	28	29	30	32	33	35	36	38	39	41
10 km/h Cyc	6800	7545	8285	8465	8650	8830	9010	9225	9435	9650	9860	10075	10285	10500	10710
10 km/h Cyc Dual	5985	6640	7295	7470	7640	7815	7985	8160	8330	8505	8675	8865	9050	9240	9425
15 km/h Cyc	6200	6880	7555	7720	7885	8050	8215	8410	8605	8795	8990	9185	9380	9570	9765
15 km/h Cyc Dual	5455	6055	6650	6810	6965	7125	7280	7440	7595	7755	7910	8080	8255	8425	8595
40 km/h	4625	5215	5800	5915	6025	6140	6250	6365	6475	6590	6700	6850	7000	7150	7300

Ø inches	Description	CAI	e mm	D mm	R' mm	RC mm	Recommended Rim	Acceptable Rim	Tube (Code)	75% internal volume (litres)	Tread depth (mm)				
42	VF 580/85R42 CFO+ 183A8 TL	844076	580	2040	903	6040	DW18B(A)		802	701	58				
Bar	1.2	1.4	1.6	1.7	1.8	1.9	2	2.1	2.2	2.3	2.4	2.5	2.6	2.7	2.8
Psi	17	20	23	25	26	28	29	30	32	33	35	36	38	39	41
10 km/h Cyc	8075	8970	9860	10050	10245	10435	10625	10815	11010	11200	11390	11730	12070	12410	12750
10 km/h Cyc Dual	7110	7895	8680	8850	9015	9185	9350	9520	9685	9855	10020	10320	10620	10920	11220
15 km/h Cyc	7365	8180	8990	9165	9340	9515	9690	9860	10035	10210	10385	10695	11005	11315	11625
15 km/h Cyc Dual	6480	7195	7910	8065	8220	8370	8525	8680	8835	8985	9140	9415	9685	9960	10230
40 km/h	5450	6075	6700	6865	7025	7190	7350	7515	7675	7840	8000	8190	8375	8565	8750

Ø inches	Description	CAI	e mm	D mm	R' mm	RC mm	Recommended Rim	Acceptable Rim	Tube (Code)	75% internal volume (litres)	Tread depth (mm)				
42	VF 710/70R42 CFO+ 188A8 TL	499992	705	2097	927	6207	DW23B (A)	DW25B (A)	802	867	64				
Bar	1.2	1.4	1.6	1.7	1.8	1.9	2	2.1	2.2	2.3	2.4	2.5	2.6	2.7	2.8
Psi	17	20	23	25	26	28	29	30	32	33	35	36	38	39	41
10 km/h Cyc	9265	10330	11390	11615	11835	12060	12280	12505	12730	12950	13175	13495	13815	14130	14450
15 km/h Cyc	8450	9420	10385	10590	10795	10995	11200	11405	11610	11810	12015	12305	12595	12885	13175
40 km/h		7750	7905	8065	8220	8375	8530	8690	8845	9000	9250	9500	9750	9750	10000

* Refer to the notes at the end of the tables of this range

MICHELIN CEREXBIB 2

Tire specifications and pressure table (bar & psi). Load per tire in kg*

Ø inches	Description	CAI	e mm	D mm	R' mm	RC mm	Recommended Rim	Acceptable Rim	Tube (Code)	75% internal volume (litres)	Tread depth (mm)				
42	VF 900/60R42 CFO+ 195A8 TL	856296	843	2118	930	6281	DW30B (A)	TW30B		1227	59				
Bar	1.2 1.4 1.6	1.7 1.8 1.9	2 2.1 2.2	2.3 2.4 2.5	2.6 2.7 2.8	2.9 3 3.1	3.2 3.3 3.4	3.5 3.6 3.7	3.8 3.9 4	4.1 4.2 4.3	4.4 4.5 4.6				
Psi	17 20 23	25 26 28	29 30 32	33 35 37	38 39 41	42 44 46	48 50 52	54 56 58	60 62 64	66 68 70	72 74 76				
10 km/h Cyc	11050	12325	13600	13920	14240	14555	14875	15195	15515	15830	16150	16490	16830	17170	17510
15 km/h Cyc	10075	11240	12400	12690	12985	13275	13565	13855	14145	14435	14725	15035	15345	15655	15965
30 km/h Cyc	8450	9425	10400	10645	10890	11130	11375	11620	11865	12105	12350	12610	12870	13130	13390
40 km/h	7500	8375	9250	9515	9775	10040	10300	10525	10750	10975	11200	11440	11675	11915	12150

Ø inches	Description	CAI	e mm	D mm	R' mm	RC mm	Recommended Rim	Acceptable Rim	Tube (Code)	75% internal volume (litres)	Tread depth (mm)				
42	IF 800/70R42 CFO+ 189A8 TL	818789	770	2151	964	6387	DW27B (A)	DW25B (A) DW28B (A)		1145	58				
Bar	1.2 1.4 1.6	1.7 1.8 1.9	2 2.1 2.2	2.3 2.4 2.5	2.6 2.7 2.8	2.9 3 3.1	3.2 3.3 3.4	3.5 3.6 3.7	3.8 3.9 4	4.1 4.2 4.3	4.4 4.5 4.6				
Psi	17 20 23	25 26 28	29 30 32	33 35 37	38 39 41	42 44 46	48 50 52	54 56 58	60 62 64	66 68 70	72 74 76				
10 km/h Cyc	11050	12325	13600	13920	14240	14555	14875	15195	15515	15830	16150	16490	16830	17170	17510
15 km/h Cyc	10075	11240	12400	12690	12980	13270	13565	13855	14145	14435	14725	15035	15345	15655	15965
30 km/h Cyc	8450	9425	10400	10645	10890	11130	11375	11620	11865	12105	12350	12610	12870	13130	13390
40 km/h	6500	7250	8000	8190	8375	8565	8750	8940	9125	9315	9500	9700	9900	10100	10300

***IMPORTANT:**

The inflation pressure must always be appropriate for the load per tire, the speed of travel and the work to be done. Our recommendations above are provided subject to changes made after the date of publication of these tables (July 2020). Technical data is subject to change without prior notice.

- For standard or slope correction machines working on slopes of over 20% (11°), increase the usage pressure by 0.5 bar without exceeding the maximum load.
- Add 0.4 bar for intense road use exceeding 50% of time on road
- 10 km/h Cyc: Harvesting work with cyclic loads at 10 km/h.
- 15 km/h Cyc: Harvesting work with cyclic loads at 15 km/h.
- 30 km/h Cyc: Harvesting work with cyclic loads at 30 km/h.
- CFO+: Cyclic Field Operation generating a bonus for cyclic loads in the field at 10 km/h and 15km/h. (1,5 km maximum distance fully loaded)

HARVESTERS & FLOATERS



MICHELIN CEREXBIB

**HIGH LOAD CAPACITY
AT LOW PRESSURE
FOR LARGE HARVESTING
MACHINERY**



FOR **HARVESTING MACHINES**



BETTER YIELDS

- Potential increase in yields of up to 4% year⁽¹⁾



Greater **LOAD CAPACITY** up to 40%⁽²⁾



MORE TRACTION

- Improved traction on slopes
- Ability to work on wet ground
- +25%⁽³⁾ bigger footprint



LOWER PRESSURE

- Operates at up to 1 bar lower pressure⁽³⁾ compared to the previous generation



STEEL REINFORCED TREAD

- Great stability
- Excellent puncture resistance and better load distribution.

(1) Harper Adams University 2014/2016 (2) Internal test 2013-2015 (3) IF 1000/55 R32 CFO MICHELIN CEREXBIB vs 1050/50 R32 MICHELIN MEGAXBIB

SIZES

VF 520/80R26 CFO 168A8 TL
VF 620/70R26 CFO 173A8 TL
VF 750/65R26 CFO 177A8 TL
VF 620/70R30 CFO 172A8 TL
VF 520/85R30 CFO 172A8 TL
IF 800/65R32 CFO 178A8/178B TL

IF 900/60R32 CFO 185A8 TL
IF 1000/55R32 CFO 188A8 TL
IF 680/85R32 CFO 179A8/179B TL
IF 800/70R32 CFO 182A8/182B TL
IF 680/75R38 180A8 TL
IF 900/60R38 CFO 188A8 TL

IF 900/60R38 CFO 184A8 TL
IF 800/70R38 CFO 184A8/184B TL
IF 800/70R38 CFO 187A8 TL
VF 520/85R42 CFO 177A8 TL
IF 710/70R42 CFO 182A8 TL

MICHELIN CEREXBIB

Tire specifications and pressure table (bar & psi). Load per tire in kg*

Ø inches	Description	CAI	e mm	D mm	R' mm	RC mm	Recommended Rim	Acceptable Rim	Tube (Code)	75% internal volume (litres)	Tread depth (mm)				
26	VF 520/80R26 CFO 168A8 TL	972024	503	1491	649	4397	DW16L	W16L DW18L	716	366	44				
Bar	1.2	1.4	1.6	1.7	1.8	1.9	2	2.1	2.2	2.3	2.4	2.5	2.6	2.7	2.8
Psi	17	20	23	25	26	28	29	30	32	33	35	36	38	39	41
15 km/h Cyc	4720	5270	5820	5950	6080	6205	6335	6465	6595	6720	6850	7000	7150	7300	7450
40 km/h	3550	3965	4375	4470	4570	4665	4765	4860	4955	5055	5150	5265	5375	5490	5600

Ø inches	Description	CAI	e mm	D mm	R' mm	RC mm	Recommended Rim	Acceptable Rim	Tube (Code)	75% internal volume (litres)	Tread depth (mm)				
26	VF 620/70R26 CFO 173A8 TL	656967	606	1513	655	4458	DW20B (A)		716	463	45				
Bar	1.2	1.4	1.6	1.7	1.8	1.9	2	2.1	2.2	2.3	2.4	2.5	2.6	2.7	2.8
Psi	17	20	23	25	26	28	29	30	32	33	35	36	38	39	41
15 km/h Cyc	5485	6170	6850	6990	7135	7275	7415	7555	7700	7840	7980	8150	8315	8485	8650
40 km/h	4125	4640	5150	5255	5365	5470	5575	5680	5790	5895	6000	6125	6250	6375	6500

Ø inches	Description	CAI	e mm	D mm	R' mm	RC mm	Recommended Rim	Acceptable Rim	Tube (Code)	75% internal volume (litres)	Tread depth (mm)				
26	VF 750/65R26 CFO 177A8 TL	811382	743	1623	701	4780	DW25B (A)		833	659	48				
Bar	1.2	1.4	1.6	1.7	1.8	1.9	2	2.1	2.2	2.3	2.4				
Psi	17	20	23	25	26	28	29	30	32	33	35				
15 km/h Cyc	6850	7515	8180	8370	8565	8755	8945	9135	9330	9520	9710				
40 km/h	5150	5650	6150	6295	6440	6580	6725	6870	7015	7155	7300				

Ø inches	Description	CAI	e mm	D mm	R' mm	RC mm	Recommended Rim	Acceptable Rim	Tube (Code)	75% internal volume (litres)	Tread depth (mm)				
30	VF 620/70R30 CFO 172A8 TL <i>Tire for harvesting machinery</i>	886789	598	1615	700	4760	DW20B (A)		737	506	43				
Bar	1.2	1.4	1.6	1.7	1.8	1.9	2	2.1	2.2	2.3	2.4				
Psi	17	20	23	25	26	28	29	30	32	33	35				
15 km/h Cyc	5985	6620	7250	7390	7535	7675	7815	7955	8100	8240	8380				
40 km/h	4500	4975	5450	5555	5665	5770	5875	5980	6090	6195	6300				

Ø inches	Description	CAI	e mm	D mm	R' mm	RC mm	Recommended Rim	Acceptable Rim	Tube (Code)	75% internal volume (litres)	Tread depth (mm)				
30	VF 520/85R30 CFO 172A8 TL	795916	522	1624	709	4794	W16L		737	435	46				
Bar	1.2	1.4	1.6	1.7	1.8	1.9	2	2.1	2.2	2.3	2.4	2.5	2.6	2.7	2.8
Psi	17	20	23	25	26	28	29	30	32	33	35	36	38	39	41
15 km/h Cyc	5320	5905	6485	6640	6795	6945	7100	7255	7410	7560	7715	7880	8050	8215	8380
40 km/h	4000	4440	4875	4990	5105	5220	5340	5455	5570	5685	5800	5925	6050	6175	6300

* Refer to the notes at the end of the tables of this range

MICHELIN CEREXBIB

Tire specifications and pressure table (bar & psi). Load per tire in kg*

Ø inches	Description	CAI	e mm	D mm	R' mm	RC mm	Recommended Rim	Acceptable Rim	Tube (Code)	75% internal volume (litres)	Tread depth (mm)
32	IF 800/65R32 CFO 178A8/178B TL <i>Tire for harvesting machinery</i>	651074	768	1855	818	5493	DW27B (A)	DW30B (A)	831	903	57
Bar	1.2 1.4 1.6	1.7 1.8 1.9	2 2.1 2.2	2.3 2.4							
Psi	17 20 23	25 26 28	29 30 32	33 35							
15 km/h Cyc	8215	8990	9765	10000	10230	10465	10695	10930	11160	11395	11625
40 km/h	5300	5800	6300	6450	6600	6750	6900	7050	7200	7350	7500

Ø inches	Description	CAI	e mm	D mm	R' mm	RC mm	Recommended Rim	Acceptable Rim	Tube (Code)	75% internal volume (litres)	Tread depth (mm)				
32	IF 900/60R32 CFO 185A8 TL	752825	856	1906	844	5643	DW27B (A)	DW30B (A)	831	1033	58				
Bar	1.2 1.4 1.6	1.7 1.8 1.9	2 2.1 2.2	2.3 2.4	2.5 2.6 2.7 2.8										
Psi	17 20 23	25 26 28	29 30 32	33 35	36 38 39 41										
15 km/h Cyc	8990	9995	11000	11270	11545	11815	12090	12360	12630	12905	13175	13465	13760	14050	14340
40 km/h	5800	6450	7100	7275	7450	7625	7800	7975	8150	8325	8500	8690	8875	9065	9250

Ø inches	Description	CAI	e mm	D mm	R' mm	RC mm	Recommended Rim	Acceptable Rim	Tube (Code)	75% internal volume (litres)	Tread depth (mm)				
32	IF 1000/55R32 CFO 188A8 TL	131720	1040	1931	882	5758	36.00VA			1178	59				
Bar	1.2 1.4 1.6	1.7 1.8 1.9	2 2.1 2.2	2.3 2.4	2.5 2.6 2.7 2.8										
Psi	17 20 23	25 26 28	29 30 32	33 35	36 38 39 41										
15 km/h Cyc	9765	10890	12015	12305	12595	12885	13180	13470	13760	14050	14340	14630	14920	15210	15500
40 km/h	6300	7025	7750	7940	8125	8315	8500	8690	8875	9065	9250	9440	9625	9815	10000

Ø inches	Description	CAI	e mm	D mm	R' mm	RC mm	Recommended Rim	Acceptable Rim	Tube (Code)	75% internal volume (litres)	Tread depth (mm)
32	IF 680/85R32 CFO 179A8/179B TL	932041	682	1935	844	5711	DW23B (A)	DW21B (A)	831	859	46
Bar	1.2 1.4 1.6	1.7 1.8 1.9	2 2.1 2.2	2.3 2.4							
Psi	17 20 23	25 26 28	29 30 32	33 35							
15 km/h Cyc	8450	9420	10385	10590	10795	10995	11200	11405	11610	11810	12015
40 km/h	5450	6075	6700	6830	6965	7095	7225	7355	7490	7620	7750

Ø inches	Description	CAI	e mm	D mm	R' mm	RC mm	Recommended Rim	Acceptable Rim	Tube (Code)	75% internal volume (litres)	Tread depth (mm)
32	IF 800/70R32 CFO 182A8/182B TL	525718	784	1958	864	5788	DW27B (A)		831	966	55
Bar	1.2 1.4 1.6	1.7 1.8 1.9	2 2.1 2.2	2.3 2.4							
Psi	17 20 23	25 26 28	29 30 32	33 35							
15 km/h Cyc	8990	10000	11005	11275	11550	11820	12090	12360	12635	12905	13175
40 km/h	5800	6450	7100	7275	7450	7625	7800	7975	8150	8325	8500

* Refer to the notes at the end of the tables of this range

MICHELIN CEREXBIB

Tire specifications and pressure table (bar & psi). Load per tire in kg*

Ø inches	Description	CAI	e mm	D mm	R' mm	RC mm	Recommended Rim	Acceptable Rim	Tube (Code)	75% internal volume (litres)	Tread depth (mm)
38	IF 680/75R38 180A8 TL	833220	663	1965	874	5823	DW23B (A)	DW21B (A)	804	803	59
Bar	1.2 1.4 1.6	1.7 1.8 1.9	2 2.1 2.2	2.3 2.4 2.5	2.6 2.7 2.8						
Psi	17 20 23	25 26 28	29 30 32	33 35 36	38 39 41						
15 km/h Cyc	7980 8875 9765	10000 10230 10465	10695 10930 11160	11395 11625 11820	12015 12205 12400						
15 km/h Cyc > slope 20%		7980 8425 8875	9320 9765 10000	10230 10465 10695	10930 11160 11395						
40 km/h	5150 5725 6300	6450 6600 6750	6900 7050 7200	7350 7500 7625	7750 7875 8000						

Ø inches	Description	CAI	e mm	D mm	R' mm	RC mm	Recommended Rim	Acceptable Rim	Tube (Code)	75% internal volume (litres)	Tread depth (mm)
38	IF 900/60R38 CFO 188A8 TL <i>Textile belted</i>	853436	879	2029	902	6017	DW30B (A)			1149	58
Bar	1.2 1.4 1.6	1.7 1.8 1.9	2 2.1 2.2	2.3 2.4 2.5	2.6 2.7 2.8						
Psi	17 20 23	25 26 28	29 30 32	33 35 36	38 39 41						
15 km/h Cyc	9765 10885 12000	12245 12490 12730	12975 13220 13465	13705 13950 14350	14750 15150 15550						
40 km/h	6300 7025 7750	7905 8065 8220	8375 8530 8690	8845 9000 9250	9500 9750 10000						

Ø inches	Description	CAI	e mm	D mm	R' mm	RC mm	Recommended Rim	Acceptable Rim	Tube (Code)	75% internal volume (litres)	Tread depth (mm)
38	IF 900/60R38 CFO 184A8 TL <i>Textile belted</i>	296920	874	2033	904	6017	DW30B (A)			1149	58
Bar	1.2 1.4 1.6	1.7 1.8 1.9	2 2.1 2.2	2.3 2.4							
Psi	17 20 23	25 26 28	29 30 32	33 35							
15 km/h Cyc	9765 10885 12000	12245 12490 12730	12975 13220 13465	13705 13950							
40 km/h	6300 7025 7750	7905 8065 8220	8375 8530 8690	8845 9000							

Ø inches	Description	CAI	e mm	D mm	R' mm	RC mm	Recommended Rim	Acceptable Rim	Tube (Code)	75% internal volume (litres)	Tread depth (mm)
38	IF 800/70R38 CFO 184A8/184B TL	646846	781	2048	908	6072	DW27B (A)		804	1088	57
Bar	1.2 1.4 1.6	1.7 1.8 1.9	2 2.1 2.2	2.3 2.4							
Psi	17 20 23	25 26 28	29 30 32	33 35							
15 km/h Cyc	9765 10885 12000	12245 12490 12730	12975 13220 13465	13705 13950							
40 km/h	6300 7025 7750	7905 8065 8220	8375 8530 8690	8845 9000							

Ø inches	Description	CAI	e mm	D mm	R' mm	RC mm	Recommended Rim	Acceptable Rim	Tube (Code)	75% internal volume (litres)	Tread depth (mm)
38	IF 800/70R38 CFO 187A8 TL	445898	790	2051	912	6079	DW27B (A)		804	1088	57
Bar	1.2 1.4 1.6	1.7 1.8 1.9	2 2.1 2.2	2.3 2.4 2.5	2.6 2.7 2.8						
Psi	17 20 23	25 26 28	29 30 32	33 35 36	38 39 41						
15 km/h Cyc	9765 10885 12000	12245 12490 12730	12975 13220 13465	13705 13950 14240	14530 14820 15110						
40 km/h	6300 7025 7750	7905 8065 8220	8375 8530 8690	8845 9000 9190	9375 9565 9750						

* Refer to the notes at the end of the tables of this range

MICHELIN CEREXBIB

Tire specifications and pressure table (bar & psi). Load per tire in kg*

Ø inches	Description	CAI	e mm	D mm	R' mm	RC mm	Recommended Rim	Acceptable Rim	Tube (Code)	75% internal volume (litres)	Tread depth (mm)				
42	VF 520/85R42 CFO 177A8 TL	934265	541	1953	881	5807	DW188(A)	DD18 DW18L	802	545	55				
Bar	1.2	1.4	1.6	1.7	1.8	1.9	2	2.1	2.2	2.3	2.4	2.5	2.6	2.7	2.8
Psi	17	20	23	25	26	28	29	30	32	33	35	36	38	39	41
15 km/h Cyc Dual	5455	5865	6275	6480	6685	6885	7090	7295	7500	7705	7910	8080	8255	8425	8595
40 km/h	4625	4970	5315	5490	5665	5835	6010	6180	6355	6525	6700	6850	7000	7150	7300

Ø inches	Description	CAI	e mm	D mm	R' mm	RC mm	Recommended Rim	Acceptable Rim	Tube (Code)	75% internal volume (litres)	Tread depth (mm)			
42	IF 710/70R42 CFO 182A8 TL	003912	705	2097	942	6230	DW23B (A)		802	872	64			
Bar	1.4	1.6	1.7	1.8	1.9	2	2.1	2.2	2.3	2.4	2.5	2.6	2.7	2.8
Psi	20	23	25	26	28	29	30	32	33	35	36	38	39	41
15 km/h Cyc	9300	10385	10590	10790	10995	11200	11400	11605	11805	12010	12300	12595	12885	13175
40 km/h	6000	6700	6830	6965	7095	7225	7355	7490	7620	7750	7940	8125	8315	8500

***IMPORTANT:**

The inflation pressure must always be appropriate for the load per tire, the speed of travel and the work to be done. Our recommendations above are provided subject to changes made after the date of publication of these tables (July 2020). Technical data is subject to change without prior notice.

CEREXBIB tires carrying the markings IF or VF and CFO have been developed to comply with the experimental ETRTO standard, introduced in 2014 for a period of 4 months, prior to the possible adoption of a new standard. Tires which meet this new experimental standard must carry the letters IF or VF as a prefix to the size and the letters CFO as a suffix, and tolerate the increase in load indicated in the table above. Tires not carrying this special marking cannot tolerate an increase in load in cyclic load conditions.

- For standard or slope correction machines working on slopes of over 20% (11°), increase the usage pressure by 0.5 bar without exceeding the maximum load.
- Add 0.4 bar for intense road use exceeding 50% of time on road
- 15 km/h Cyc: Harvesting work with cyclic loads at 15 km/h.
- CFO: Cyclic Field Operation generating a bonus for cyclic loads in the field (1,5 km maximum distance fully loaded)

HARVESTERS & FLOATERS



MICHELIN FLOATXBIB

**THE HIGHEST LOAD
CAPACITY IN THE FIELD
AND HIGHEST SPEED INDEX
ON ROADS**



FOR **FLOATERS** AND **APPLICATORS**



INCREASED PRODUCTIVITY

- Even pressure distribution across the contact patch
- Improved stubble resistance & wear
- New Innovative tread pattern and new rubber compound providing ULTRAFLEX benefits: low pressure, high load and speed capacity
- 1st VF CFO index E for floater usage
(CFO allows an increased load capacity of 55% when operating under 15 km/h)



IMPROVED YIELDS

- Rounded shoulders enable vegetation protection
- Doubled & reinforced shoulder lugs improve contact patch



IMPROVED COMFORT

- Reinforced central area with special lug design

SIZES

VF 1000/50R25 CFO 190D/186E TL **NEW**

VF 750/50R26 CFO 174D/170E TL **NEW**

IF 1000/55R32 CFO 191D/188E TL

VF 1000/55R32 CFO 197D/193E TL **NEW**

VF 900/60R38 CFO 196D/192E TL **NEW**

MICHELIN FLOATXBIB

Tire specifications and pressure table (bar & psi). Load per tire in kg*

Ø inches	Description	CAI	e mm	D mm	R' mm	RC mm	Recommended Rim	Acceptable Rim	Tube (Code)	75% internal volume (litres)	Tread depth (mm)
25	VF 1000/50R25 CFO 190D/186E TL <small>NEW</small>	713716	1040	1636	717	4845	36.0TH			893	40
Bar	1.2	1.4	1.6	1.8	2	2.2	2.4	2.6	2.8	3	3.2
Psi	17	20	23	26	29	32	35	38	41	44	46
15 km/h Cyc	8215	9145	10075	10540	11005	11510	12013	12595	13175	13565	13950
30 km/h Cyc	6890	7670	8450	8840	9230	9655	10075	10565	11050	11375	11700
65 km/h	6150	6825	7500	7875	8250	8625	9000	9375	9750	10175	10600
70 km/h	5597	6210	6825	7165	7508	7850	8190	8530	8873	9185	9500

Ø inches	Description	CAI	e mm	D mm	R' mm	RC mm	Recommended Rim	Acceptable Rim	Tube (Code)	75% internal volume (litres)	Tread depth (mm)
26	VF 750/50R26 CFO 174D/170E TL <small>NEW</small>	982905	749.5	1405	619	4155	DW25B (A)			458	39
Bar	1.2	1.4	1.6	1.8	2	2.2	2.4	2.6	2.8	3	3.2
Psi	17	20	23	26	29	32	35	38	41	44	46
15 km/h Cyc	5193	5795	6394	6685	6975	7265	7556	8000	8448	8720	8990
30 km/h Cyc	4355	4860	5363	5605	5850	6095	6338	6710	7085	7315	7540
65 km/h	3875	4315	4750	5025	5300	5550	5800	6050	6300	6500	6700
70 km/h	3526	3925	4323	4575	4823	5050	5278	5505	5733	5865	6000

Ø inches	Description	CAI	e mm	D mm	R' mm	RC mm	Recommended Rim	Acceptable Rim	Tube (Code)	75% internal volume (litres)	Tread depth (mm)
32	IF 1000/55R32 CFO 191D/188E TL	564739	1042	1877	820	5540	36.00VA			1178	38
Bar	1.2	1.4	1.6	1.8	2	2.2	2.4	2.6	2.8	3	3.2
Psi	17	20	23	26	29	32	35	38	41	44	46
15 km/h Cyc	9765	10890	12013	12595	13175	13755	14338	14920	15500	16200	16895
30 km/h Cyc	8190	9135	10075	10565	11050	11540	12025	12515	13000	13585	14170
65 km/h	6300	7025	7750	8125	8500	8875	9250	9625	10000	10450	10900
70 km/h	5800	6450	7100	7425	7750	8125	8500	8875	9250	9625	10000

Ø inches	Description	CAI	e mm	D mm	R' mm	RC mm	Recommended Rim	Acceptable Rim	Tube (Code)	75% internal volume (litres)	Tread depth (mm)
32	VF 1000/55R32 CFO 197D/193E TL <small>NEW</small>	946690	1042	1877	805	5520	36.00VA			1178	
Bar	1.2	1.4	1.6	1.8	2	2.2	2.4	2.6	2.8	3	3.2
Psi	17	20	23	26	29	32	35	38	41	44	46
15 km/h Cyc	9765	10890	12015	12595	13175	13760	14340	14920	15500	16200	16895
30 km/h Cyc	8190	9135	10075	10565	11050	11540	12025	12515	13000	13585	14170
65 km/h	7300	7775	8250	9125	10000	10450	10900	11350	11800	12325	12850
70 km/h	6650	7075	7500	8300	9100	9500	9900	10325	10750	11225	11700

* Refer to the notes at the end of the tables of this range

MICHELIN FLOATXBIB

Tire specifications and pressure table (bar & psi). Load per tire in kg*

Ø inches	Description	CAI	e mm	D mm	R' mm	RC mm	Recommended Rim	Acceptable Rim	Tube (Code)	75% internal volume (litres)	Tread depth (mm)
38	VF 900/60R38 CFO 196D/192E TL_{NEW}	098689	872	2033	914	6041	DW30B (A)	DW27B (A)		1149	39
Bar	1.2	1.4	1.6	1.8	2	2.2	2.4	2.6	2.8	3	3.2
Psi	17	20	23	26	29	32	35	38	41	44	46
15 km/h Cyc	9533	10580	11625	12400	13175	13565	13950	14725	15500	15965	16430
30 km/h Cyc	7995	8875	9750	10400	11050	11375	11700	12350	13000	13390	13780
65 km/h	7300	8025	8750	9250	9750	10175	10600	11050	11500	12000	12500
70 km/h	6643	7305	7963	8420	8873	9260	9646	10055	10465	10835	11200

***IMPORTANT:**

The inflation pressure must always be appropriate for the load per tire, the speed of travel and the work to be done. Our recommendations above are provided subject to changes made after the date of publication of these tables (July 2020). Technical data is subject to change without prior notice.

- For standard or slope correction machines working on slopes of over 20% (11°), increase the usage pressure by 0.5 bar without exceeding the maximum load.
- Add 0.4 bar for intense road use exceeding 50% of time on road
- 15 km/h Cyc: Harvesting work with cyclic loads at 15 km/h.
- CFO: Cyclic Field Operation generating a bonus for cyclic loads in the field (1,5 km maximum distance fully loaded)

HARVESTERS & FLOATERS



MICHELIN MEGAXBIB 2

EXCELLENT VALUE
FOR HARVESTERS
& HEAVY EQUIPMENT



FOR FLOATERS AND HARVESTERS



ROBUST AND MORE RESISTANT TO STUBBLE

- Reinforced carcass
- Long tire life



MEGAXBIB RANGE BENEFITS

- Excellent road handling
- High load/speed capacities



NEW MARKING

- Stubble Shield



STEEL REINFORCED TREAD

- Great stability
- Excellent puncture resistance and better load distribution.

SIZES

1000/50R25 172A8/166D TL

750/50R26 160A8/154D TL

650/75R32 172A8/172B TL

800/65R32 178A8/178B TL

1050/50R32 178A8/172D TL

900/60R32 181A8/181B TL

800/70R32 181A8/181B TL **NEW**

710/75R34 178A8/178B TL **NEW**

620/70R38 170A8/170B TL **NEW**

MICHELIN MEGAXBIB 2

Tire specifications and pressure table (bar & psi). Load per tire in kg*

Ø inches	Description	CAI	e mm	D mm	R' mm	RC mm	Recommended Rim	Acceptable Rim	Tube (Code)	75% internal volume (litres)	Tread depth (mm)
25	1000/50R25 172A8/166D TL	852423	1033	1654	732	4907	36.0TH			892	46
Bar	1 1.3 1.6	1.9 2.2 2.3	2.4 2.5 2.6	2.7 2.8							
Psi	15 19 23	28 32 33	35 36 38	39 41							
10 km/h	5815 6940 7740	8385 9025 9235	9450								
10 km/h Cyc		8290 9005 9725	9960 10200 10330	10455 10585 10710							
30 km/h	4145 4950 5670	6070 6475 6605	6740								
30 km/h Cyc		6565 7480 8390	8695 9000 9115	9225 9340 9450							
40 km/h	3875 4625 5300	5675 6050 6175	6300								
65 km/h	3255 3885 4450	4765 5080 5185	5290								

Ø inches	Description	CAI	e mm	D mm	R' mm	RC mm	Recommended Rim	Acceptable Rim	Tube (Code)	75% internal volume (litres)	Tread depth (mm)
26	750/50R26 160A8/154D TL	236906	742	1406	629	4171	DW25B (A)			466	39
Bar	1 1.3 1.6	1.9 2.2 2.3	2.4 2.5 2.6	2.7 2.8	2.9 3.2						
Psi	15 19 23	28 32 33	35 36 38	39 41	42 46						
10 km/h	3750 4400 5175	5555 5935 6065	6190 6330 6470	6610 6750							
10 km/h Cyc		5230 5660 6090	6230 6375 6535	6695 6855 7015	7170 7650						
30 km/h	2675 3135 3690	3960 4235 4325	4415 4515 4615	4715 4815							
30 km/h Cyc		4200 4735 5270	5445 5625 5765	5910 6050 6190	6330 6750						
40 km/h	2500 2930 3450	3705 3955 4040	4125 4220 4310	4405 4500							
65 km/h	2100 2465 2900	3110 3325 3395	3465 3545 3620	3700 3780							

Ø inches	Description	CAI	e mm	D mm	R' mm	RC mm	Recommended Rim	Acceptable Rim	Tube (Code)	75% internal volume (litres)	Tread depth (mm)
32	650/75R32 172A8/172B TL	642277	637.7	1817	817	5400	DW21B (A)	DW20B (A) DW23B (A)		647	56
Bar	1 1.3 1.6	1.9 2.2 2.3	2.4 2.5 2.6	2.7 2.8	2.9 3.2 3.5 3.8						
Psi	15 19 23	28 32 33	35 36 38	39 41	42 46 51 55						
10 km/h	4500 5220 5940	6420 6895 7055	7215 7375 7535	7695 7855 8015	8495 8970 9450						
10 km/h Cyc	4900 5710 6520	7090 7665 7855	8045 8235 8425	8615 8805 8995	9565 10140 10710						
25 km/h	3630 4235 4840	5245 5645 5780	5915 6050 6185	6320 6455 6590	6990						
30 km/h	3500 4085 4670	5060 5445 5575	5705 5835 5965	6095 6225 6355	6740						
40 km/h	3280 3820 4360	4725 5090 5210	5330 5450 5575	5695 5815 5935	6300						
50 km/h	3280 3820 4360	4725 5090 5210	5330 5450 5575	5695 5815 5935	6300						

* Refer to the notes at the end of the tables of this range

MICHELIN MEGAXBIB 2

Tire specifications and pressure table (bar & psi). Load per tire in kg*

Ø inches	Description		CAI	e mm	D mm	R' mm	RC mm	Recommended Rim		Acceptable Rim		Tube (Code)	75% internal volume (litres)		Tread depth (mm)	
32	800/65R32 178A8/178B TL		135425	786	1839	832	5471	DW27B (A)	DW25B (A) DH27(B)	831	871	831	871	831	871	56.2
Bar	1	1.3	1.6	1.9	2.2	2.3	2.4	2.5	2.6	2.7	2.8	2.9	3.2	3.5	3.8	
Psi	15	19	23	28	32	33	35	36	38	39	41	42	46	51	55	
10 km/h	5175	6060	6940	7600	8260	8480	8700	8890	9075	9265	9450	9630	10170	10710	11250	
10 km/h Cyc	5865	7080	8290	8880	9470	9665	9860	10075	10285	10500	10710	10915	11525	12140	12750	
25 km/h	4440	5165	5885	6300	6720	6855	6995	7160	7330	7495	7660	7825	8325			
30 km/h	4280	4975	5670	6070	6475	6605	6740	6900	7065	7225	7385	7545	8025			
40 km/h	4000	4650	5300	5675	6050	6175	6300	6450	6600	6750	6900	7050	7500			
50 km/h	4000	4650	5300	5675	6050	6175	6300	6450	6600	6750	6900	7050	7500			

Ø inches	Description		CAI	e mm	D mm	R' mm	RC mm	Recommended Rim		Acceptable Rim		Tube (Code)	75% internal volume (litres)		Tread depth (mm)
32	1050/50R32 178A8/172D TL		424273	1037	1866	828	5537	36.00VA					1233	42	
Bar	1	1.3	1.6	1.9	2.2	2.3	2.4	2.5	2.6	2.7	2.8				
Psi	15	19	23	28	32	33	35	36	38	39	41				
10 km/h	6940	8260	9450	10125	10800	11025	11250								
10 km/h Cyc			9860	10690	11520	11795	12070	12240	12410	12580	12750				
30 km/h	4950	5890	6740	7220	7705	7865	8025								
30 km/h Cyc			7725	8820	9920	10285	10650	10800	10950	11100	11250				
40 km/h	4625	5505	6300	6750	7200	7350	7500								
65 km/h	3885	4625	5290	5670	6050	6175	6300								

Ø inches	Description		CAI	e mm	D mm	R' mm	RC mm	Recommended Rim		Acceptable Rim		Tube (Code)	75% internal volume (litres)		Tread depth (mm)	
32	900/60R32 181A8/181B TL		166896	861.6	1899	848	5635	DW27B (A)	DW30B (A)	831	1033	831	1033	831	1033	56.6
Bar	1	1.3	1.6	1.9	2.2	2.3	2.4	2.5	2.6	2.7	2.8	2.9	3.2	3.5	3.8	
Psi	15	19	23	28	32	33	35	36	38	39	41	42	46	51	55	
10 km/h	5625	6675	7725	8485	9245	9495	9750	9975	10200	10425	10650	10825	11340	11860	12375	
10 km/h Cyc	6375	7695	9010	9775	10540	10795	11050	11305	11560	11815	12070	12265	12850	13440	14025	
25 km/h	4720	5580	6440	6980	7520	7700	7880	8060	8245	8425	8605	8745	9160			
30 km/h	4550	5380	6205	6725	7250	7420	7595	7770	7945	8120	8295	8430	8830			
40 km/h	4250	5025	5800	6290	6775	6940	7100	7265	7425	7590	7750	7875	8250			
50 km/h	4250	5025	5800	6290	6775	6940	7100	7265	7425	7590	7750	7875	8250			

* Refer to the notes at the end of the tables of this range

MICHELIN MEGAXBIB 2

Tire specifications and pressure table (bar & psi). Load per tire in kg*

Ø inches	Description	CAI	e mm	D mm	R' mm	RC mm	Recommended Rim	Acceptable Rim	Tube (Code)	75% internal volume (litres)	Tread depth (mm)				
32	800/70R32 181A8/181B TL NEW	366785	803	1927		5737	DW27B (A)	DW25B (A)	831	966	56.5				
Bar	1 1.3 1.6	1.9 2.2 2.3	2.4 2.5 2.6	2.7 2.8	2.9 3.2 3.5	3.8									
Psi	15 19 23	28 32 33	35 36 38	39 41	42 46 51	55									
10 km/h	5625	6675	7725	8830	9475	9615	9750	9900	10050	10200	10350	10555	11160	11770	12375
10 km/h Cyc	6375	7820	9265	9965	10625	10840	11050	11220	11390	11560	11730	11960	12650	13335	14025
20 km/h	5335	6360	7380	7795	8210	8345	8485	8695	8900	9110	9320	9525	10150		
25 km/h	4815	5740	6660	7035	7410	7535	7660	7850	8035	8225	8410	8600	9160		
30 km/h	4680	5550	6420	6780	7140	7260	7380	7560	7745	7925	8105	8285	8830		
40 km/h	4375	5190	6000	6340	6675	6790	6900	7070	7240	7405	7575	7745	8250		
50 km/h	4375	5190	6000	6340	6675	6790	6900	7070	7240	7405	7575	7745	8250		

Ø inches	Description	CAI	e mm	D mm	R' mm	RC mm	Recommended Rim	Acceptable Rim	Tube (Code)	75% internal volume (litres)	Tread depth (mm)				
34	710/75R34 178A8/178B TL NEW	312036	697	1909	857	5671	DW23B (A)	DW21B (A) MW23B (A)	765	863	56				
Bar	1 1.3 1.6	1.9 2.2 2.3	2.4 2.5 2.6	2.7 2.8	2.9 3.2 3.5	3.8									
Psi	15 19 23	28 32 33	35 36 38	39 41	42 46 51	55									
10 km/h	5700	6295	6890	7485	8080	8275	8475	8675	8870	9070	9270	9465	10060	10655	11250
10 km/h Cyc	6260	6955	7650	8345	9040	9275	9505	9735	9970	10200	10430	10665	11360	12055	12750
25 km/h	4650	5150	5655	6155	6655	6825	6990	7160	7325	7495	7660	7830	8330		
30 km/h	4480	4965	5450	5930	6415	6580	6740	6900	7060	7225	7385	7545	8030		
40 km/h	4190	4640	5095	5545	5995	6145	6295	6445	6595	6750	6900	7050	7500		
50 km/h	4190	4640	5095	5545	5995	6145	6295	6445	6595	6750	6900	7050	7500		

Ø inches	Description	CAI	e mm	D mm	R' mm	RC mm	Recommended Rim	Acceptable Rim	Tube (Code)	75% internal volume (litres)	Tread depth (mm)				
38	620/70R38 170A8/170B TL NEW	126128	614	1857		5548	DW20B (A)	DW18L	825	592	56.5				
Bar	1 1.3 1.6	1.9 2.2 2.3	2.4 2.5 2.6	2.7 2.8	2.9 3.2 3.5	3.8									
Psi	15 19 23	28 32 33	35 36 38	39 41	42 46 51	55									
10 km/h	4560	5035	5510	5985	6465	6620	6780	6940	7095	7255	7415	7575	8050	8525	9000
10 km/h Cyc	5010	5565	6120	6680	7235	7420	7605	7790	7975	8160	8345	8530	9090	9645	10200
25 km/h	3710	4110	4515	4915	5320	5455	5585	5720	5855	5990	6125	6260	6660		
30 km/h	3580	3965	4355	4740	5130	5260	5385	5515	5645	5775	5905	6035	6420		
40 km/h	3350	3710	4075	4435	4795	4915	5035	5155	5275	5400	5520	5640	6000		
50 km/h	3350	3710	4075	4435	4795	4915	5035	5155	5275	5400	5520	5640	6000		

***IMPORTANT:**

The inflation pressure must always be appropriate for the load per tire, the speed of travel and the work to be done. Our recommendations above are provided subject to changes made after the date of publication of these tables (July 2020). Technical data is subject to change without prior notice.

- For standard or slope correction machines working on slopes of over 20% (11°), use the 10 km/h non-cyclic line
- For harvesters, use 10 km/h non-cyclic table and the 30 km/h non-cyclic table for floaters.
- Add 0.4 bar for intense road use exceeding 50% of time on road
- 10 km/h or 30 km/h cyclic load, use in the field only, travel with full load not to exceed 1,5 km.

HARVESTERS & FLOATERS



MICHELIN MEGAXBIB

EXCELLENT VALUE
FOR HARVESTERS
& HEAVY EQUIPMENT



FOR HARVESTING MACHINES



LOAD CAPACITY

- Up to 30 600 kg⁽¹⁾ per axle



ENDURANCE

- Up to +46%⁽²⁾ vs main competitor



COMFORT



STEEL REINFORCED TREAD

- Great stability
- Excellent puncture resistance and better load distribution.

(1) 1050/50 R32 184A8/184B - 10 km/h Cyc (2) Internal test (Ladoux - France) study on 800/65R32 178A8/178B

SIZES

750/50R26 160A8/154D TL

620/75R26 166A8/166B TL

750/65R26 171A8/171B TL

620/75R30 168A8/168B TL

650/75R32 172A8/172B TL

800/65R32 178A8/178B TL

1050/50R32 184A8/184B TL

900/60R32 181A8/181B TL

1050/50R32 178A8 TL

800/70R32 181A8/181B TL

620/75R34 170A8/170B TL

710/75R34 178A8/178B TL

620/70R38 170A8/170B TL

650/85R38 173A8/173B TL

520/85R42 162A8/162B TL

620/70R42 166A8/166B TL

MICHELIN MEGAXBIB

Tire specifications and pressure table (bar & psi). Load per tire in kg*

Ø inches	Description	CAI	e mm	D mm	R' mm	RC mm	Recommended Rim	Acceptable Rim	Tube (Code)	75% internal volume (litres)	Tread depth (mm)
26	750/50R26 160A8/154D TL	478428	738	1404	625	4162	DW25B (A)			458	37
Bar	1 1.3 1.6 1.9 2.2 2.3 2.4 2.5 2.6 2.7 2.8 2.9 3.2										
Psi	15 19 23 28 32 33 35 36 38 39 41 42 46										
10 km/h	3750 4395 5175 5555 5935 6065 6190 6330 6470 6610 6750										
10 km/h Cyc	5230 5660 6090 6230 6375 6535 6695 6855 7015 7170 7650										
30 km/h	2675 3135 3690 3960 4235 4325 4415 4515 4615 4715 4815										
30 km/h Cyc	4200 4735 5270 5445 5625 5765 5910 6050 6190 6330 6750										
40 km/h	2500 2930 3450 3705 3955 4040 4125 4220 4315 4405 4500										
65 km/h	2100 2465 2900 3110 3325 3395 3465 3545 3625 3700 3780										

Ø inches	Description	CAI	e mm	D mm	R' mm	RC mm	Recommended Rim	Acceptable Rim	Tube (Code)	75% internal volume (litres)	Tread depth (mm)
26	620/75R26 166A8/166B TL	614320	588	1602	712	4748	DW20B (A)	DW18L	830	516	46
Bar	1 1.3 1.6 1.9 2.2 2.3 2.4 2.5 2.6 2.7 2.8 2.9 3.2 3.5 3.8										
Psi	15 19 23 28 32 33 35 36 38 39 41 42 46 51 55										
10 km/h	3910 4405 4900 5315 5730 5870 6010 6150 6285 6425 6565 6700 7120 7535 7950										
10 km/h Cyc	4410 4820 5230 5745 6260 6435 6605 6775 6950 7120 7290 7465 7980 8495 9010										
25 km/h	3170 3610 4050 4395 4735 4850 4965 5080 5195 5310 5425 5535 5880										
30 km/h	3060 3480 3900 4230 4565 4675 4785 4895 5005 5115 5230 5340 5670										
40 km/h	2860 3250 3640 3950 4265 4365 4470 4575 4680 4780 4885 4990 5300										
50 km/h	2860 3250 3640 3950 4265 4365 4470 4575 4680 4780 4885 4990 5300										

Ø inches	Description	CAI	e mm	D mm	R' mm	RC mm	Recommended Rim	Acceptable Rim	Tube (Code)	75% internal volume (litres)	Tread depth (mm)
26	750/65R26 171A8/171B TL	983217	732	1621	730	4818	DW25B (A)		833	677	46
Bar	1 1.3 1.6 1.9 2.2 2.3 2.4 2.5 2.6 2.7 2.8 2.9 3.2 3.5 3.8										
Psi	15 19 23 28 32 33 35 36 38 39 41 42 46 51 55										
10 km/h	4350 5080 5760 6380 6940 7110 7285 7460 7630 7775 7920 8060 8460 8845 9225										
10 km/h Cyc	4930 5865 6675 7360 7920 8100 8285 8470 8650 8815 8975 9140 9590 10020 10455										
25 km/h	3610 4175 4735 5240 5630 5765 5895 6030 6160 6270 6380 6495 6825										
30 km/h	3480 4025 4570 5055 5420 5550 5680 5810 5940 6045 6155 6260 6580										
40 km/h	3250 3760 4265 4720 5070 5190 5310 5430 5550 5650 5750 5850 6150										
50 km/h	3250 3760 4265 4720 5070 5190 5310 5430 5550 5650 5750 5850 6150										

* Refer to the notes at the end of the tables of this range

MICHELIN MEGAXBIB

Tire specifications and pressure table (bar & psi). Load per tire in kg*

Ø inches	Description	CAI	e mm	D mm	R' mm	RC mm	Recommended Rim	Acceptable Rim	Tube (Code)	75% internal volume (litres)	Tread depth (mm)
30	620/75R30 168A8/168B TL	753673	604	1710	770	5083	DW20B (A)	DW18L	737	559	46
Bar	1 1.3 1.6 1.9 2.2 2.3 2.4 2.5 2.6 2.7 2.8 2.9 3.2 3.5 3.8										
Psi	15 19 23 28 32 33 35 36 38 39 41 42 46 51 55										
10 km/h	4130 4650 5170 5610 6050 6200 6345 6490 6640 6785 6930 7080 7520 7960 8400										
10 km/h Cyc	4660 5090 5520 6065 6610 6795 6975 7155 7340 7520 7700 7885 8430 8975 9520										
25 km/h	3360 3815 4270 4635 5000 5120 5240 5360 5485 5605 5725 5845 6210										
30 km/h	3240 3680 4120 4470 4820 4940 5055 5170 5290 5405 5525 5640 5990										
40 km/h	3030 3440 3850 4180 4505 4615 4725 4835 4945 5055 5165 5270 5600										
50 km/h	3030 3440 3850 4180 4505 4615 4725 4835 4945 5055 5165 5270 5600										

Ø inches	Description	CAI	e mm	D mm	R' mm	RC mm	Recommended Rim	Acceptable Rim	Tube (Code)	75% internal volume (litres)	Tread depth (mm)
32	650/75R32 172A8/172B TL	468227	657	1825	821	5423	DW21B (A)	DW20B (A) DW23B (A)	831	698	59
Bar	1 1.3 1.6 1.9 2.2 2.3 2.4 2.5 2.6 2.7 2.8 2.9 3.2 3.5 3.8										
Psi	15 19 23 28 32 33 35 36 38 39 41 42 46 51 55										
10 km/h	4500 5220 5940 6420 6895 7055 7215 7375 7535 7695 7855 8015 8495 8970 9450										
10 km/h Cyc	4900 5710 6520 7090 7665 7855 8045 8235 8425 8615 8805 8995 9565 10140 10710										
25 km/h	3630 4235 4840 5245 5645 5780 5915 6050 6185 6320 6455 6585 6990										
30 km/h	3500 4085 4670 5060 5445 5575 5705 5835 5965 6095 6225 6350 6740										
40 km/h	3280 3820 4360 4725 5090 5210 5330 5450 5575 5695 5815 5935 6300										
50 km/h	3280 3820 4360 4725 5090 5210 5330 5450 5575 5695 5815 5935 6300										

Ø inches	Description	CAI	e mm	D mm	R' mm	RC mm	Recommended Rim	Acceptable Rim	Tube (Code)	75% internal volume (litres)	Tread depth (mm)
32	800/65R32 178A8/178B TL	521809	793	1840	822	5459	DW27B (A)	DW25B (A) DHB27	831	903	56
Bar	1 1.3 1.6 1.9 2.2 2.3 2.4 2.5 2.6 2.7 2.8 2.9 3.2 3.5 3.8										
Psi	15 19 23 28 32 33 35 36 38 39 41 42 46 51 55										
10 km/h	5175 6060 6940 7600 8260 8480 8700 8890 9075 9265 9450 9630 10170 10710 11250										
10 km/h Cyc	5865 7080 8290 8880 9470 9665 9860 10075 10285 10500 10710 10915 11525 12140 12750										
25 km/h	4440 5165 5885 6300 6720 6855 6995 7160 7330 7495 7660 7825 8325										
30 km/h	4280 4975 5670 6070 6475 6605 6740 6900 7065 7225 7385 7545 8025										
40 km/h	4000 4650 5300 5675 6050 6175 6300 6450 6600 6750 6900 7050 7500										
50 km/h	4000 4650 5300 5675 6050 6175 6300 6450 6600 6750 6900 7050 7500										

* Refer to the notes at the end of the tables of this range

MICHELIN MEGAXBIB

Tire specifications and pressure table (bar & psi). Load per tire in kg*

Ø inches	Description	CAI	e mm	D mm	R' mm	RC mm	Recommended Rim	Acceptable Rim	Tube (Code)	75% internal volume (litres)	Tread depth (mm)
32	1050/50R32 184A8/184B TL <i>Tire for spreaders/floaters</i>	829536	1040	1856	831	5510	36.00VA			1159	41
Bar	1 1.3 1.6 1.9 2.2 2.3 2.4 2.5 2.6 2.7 2.8 2.9 3.2 3.5 3.8										
Psi	15 19 23 28 32 33 35 36 38 39 41 42 46 51 55										
10 km/h Cyc	6800 8330 9860 10710 11475 11730 11985 12240 12495 12750 13005 13260 14025 14665 15300										
25 km/h	5135 6065 6995 7495 7995 8160 8325 8535 8745 8950 9160 9370 9990										
30 km/h	4950 5845 6740 7220 7705 7865 8025 8225 8430 8630 8830 9030 9630										
30 km/h Cyc	6240 7370 8500 9045 9695 9910 10125 10380 10630 10885 11140 11390 12150 12825 13500										
40 km/h	4625 5465 6300 6750 7200 7350 7500 7690 7875 8065 8250 8440 9000										
50 km/h	4625 5465 6300 6750 7200 7350 7500 7690 7875 8065 8250 8440 9000										

Ø inches	Description	CAI	e mm	D mm	R' mm	RC mm	Recommended Rim	Acceptable Rim	Tube (Code)	75% internal volume (litres)	Tread depth (mm)
32	900/60R32 181A8/181B TL	824122	868	1894	850	5626	DW27B (A)	DW30B (A)	831	1033	56
Bar	1 1.3 1.6 1.9 2.2 2.3 2.4 2.5 2.6 2.7 2.8 2.9 3.2 3.5 3.8										
Psi	15 19 23 28 32 33 35 36 38 39 41 42 46 51 55										
10 km/h	5625 6675 7725 8485 9245 9495 9750 9975 10200 10425 10650 10825 11340 11860 12375										
10 km/h Cyc	6375 7695 9010 9775 10540 10795 11050 11305 11560 11815 12070 12265 12850 13440 14025										
25 km/h	4720 5580 6440 6980 7520 7700 7880 8060 8245 8425 8605 8745 9160										
30 km/h	4550 5380 6205 6725 7250 7420 7595 7770 7945 8120 8295 8430 8830										
50 km/h	4250 5025 5800 6290 6775 6940 7100 7265 7425 7590 7750 7875 8250										

Ø inches	Description	CAI	e mm	D mm	R' mm	RC mm	Recommended Rim	Acceptable Rim	Tube (Code)	75% internal volume (litres)	Tread depth (mm)
32	1050/50R32 178A8 TL <i>ONLY for harvesting machines</i>	236234	1038	1902	854	5649	36.00VA			1250	60
Bar	1 1.3 1.6 1.9 2.2 2.3 2.4 2.5 2.6 2.7 2.8										
Psi	15 19 23 28 32 33 35 36 38 39 41										
10 km/h	6860 7925 8990 9605 10225 10430 10635 10840 11045 11250										
10 km/h Cyc	7420 8630 9840 10635 11425 11690 11955 12220 12485 12750										
15 km/h Cyc	5350 6675 8000 9330 10390 10700 11010 11165 11320 11475 11630										
25 km/h	5570 6505 7440 7775 8110 8220 8330										
30 km/h	5370 6270 7170 7495 7815 7925 8030										
40 km/h	5020 5860 6700 7000 7300 7400 7500										

* Refer to the notes at the end of the tables of this range

MICHELIN MEGAXBIB

Tire specifications and pressure table (bar & psi). Load per tire in kg*

Ø inches	Description	CAI	e mm	D mm	R' mm	RC mm	Recommended Rim	Acceptable Rim	Tube (Code)	75% internal volume (litres)	Tread depth (mm)				
32	800/70R32 181A8/181B TL	695992	793	1936	871	5725	DW27B (A)	DW25B (A)	831	966	58				
Bar	1 1.3 1.6	1.9	2.2	2.3	2.4	2.5	2.6	2.7	2.8	2.9	3.2	3.5	3.8		
Psi	15 19 23	28	32	33	35	36	38	39	41	42	46	51	55		
10 km/h	5625	6675	7725	8830	9475	9615	9750	9900	10050	10200	10350	10555	11160	11770	12375
10 km/h Cyc	6375	7820	9265	9965	10625	10840	11050	11220	11390	11560	11730	11960	12650	13335	14025
20 km/h	5335	6360	7380	7795	8210	8345	8485	8695	8900	9110	9320	9525	10150		
25 km/h	4815	5740	6660	7035	7410	7535	7660	7850	8035	8225	8410	8600	9160		
30 km/h	4680	5550	6420	6780	7140	7260	7380	7560	7745	7925	8105	8285	8830		
40 km/h	4375	5190	6000	6340	6675	6790	6900	7070	7240	7405	7575	7745	8250		
50 km/h	4375	5190	6000	6340	6675	6790	6900	7070	7240	7405	7575	7745	8250		

Ø inches	Description	CAI	e mm	D mm	R' mm	RC mm	Recommended Rim	Acceptable Rim	Tube (Code)	75% internal volume (litres)	Tread depth (mm)				
34	620/75R34 170A8/170B TL	325025	590	1814	821	5398	DW20B (A)	DW18L		612	46				
Bar	1 1.3 1.6	1.9	2.2	2.3	2.4	2.5	2.6	2.7	2.8	2.9	3.2	3.5	3.8		
Psi	15 19 23	28	32	33	35	36	38	39	41	42	46	51	55		
10 km/h	4560	5035	5510	5985	6465	6620	6780	6940	7095	7255	7415	7575	8050	8525	9000
10 km/h Cyc	5010	5565	6120	6680	7235	7420	7605	7790	7975	8160	8345	8530	9090	9645	10200
25 km/h	3710	4110	4515	4915	5320	5455	5585	5720	5855	5990	6125	6260	6660		
30 km/h	3580	3965	4355	4740	5130	5260	5385	5515	5645	5775	5905	6035	6420		
40 km/h	3350	3710	4075	4435	4795	4915	5035	5155	5275	5400	5520	5640	6000		
50 km/h	3350	3710	4075	4435	4795	4915	5035	5155	5275	5400	5520	5640	6000		

Ø inches	Description	CAI	e mm	D mm	R' mm	RC mm	Recommended Rim	Acceptable Rim	Tube (Code)	75% internal volume (litres)	Tread depth (mm)				
34	710/75R34 178A8/178B TL	543107	690	1900	848	5637	DW23B (A)	DW21B (A) MW23B (A)	765	863	58				
Bar	1 1.3 1.6	1.9	2.2	2.3	2.4	2.5	2.6	2.7	2.8	2.9	3.2	3.5	3.8		
Psi	15 19 23	28	32	33	35	36	38	39	41	42	46	51	55		
10 km/h	5700	6295	6890	7485	8080	8275	8475	8675	8870	9070	9270	9465	10060	10655	11250
10 km/h Cyc	6260	6955	7650	8345	9040	9275	9505	9735	9970	10200	10430	10665	11360	12055	12750
25 km/h	4650	5150	5655	6155	6655	6825	6990	7160	7325	7495	7660	7830	8330		
30 km/h	4480	4965	5450	5930	6415	6580	6740	6900	7060	7225	7385	7545	8030		
40 km/h	4190	4640	5095	5545	5995	6145	6295	6445	6595	6750	6900	7050	7500		
50 km/h	4190	4640	5095	5545	5995	6145	6295	6445	6595	6750	6900	7050	7500		

* Refer to the notes at the end of the tables of this range

MICHELIN MEGAXBIB

Tire specifications and pressure table (bar & psi). Load per tire in kg*

Ø inches	Description	CAI	e mm	D mm	R' mm	RC mm	Recommended Rim	Acceptable Rim	Tube (Code)	75% internal volume (litres)	Tread depth (mm)
38	620/70R38 170A8/170B TL	476088	608	1864	850	5557	DW20B (A)	DW18L	825	587	55
Bar	1 1.3 1.6 1.9 2.2 2.3 2.4 2.5 2.6 2.7 2.8 2.9 3.2 3.5 3.8										
Psi	15 19 23 28 32 33 35 36 38 39 41 42 46 51 55										
10 km/h	4560 5035 5510 5985 6465 6620 6780 6940 7095 7255 7415 7575 8050 8525 9000										
10 km/h Cyc	5010 5565 6120 6620 7235 7420 7605 7790 7975 8160 8345 8530 9090 9645 10200										
25 km/h	3710 4110 4515 4915 5320 5455 5585 5720 5855 5990 6125 6260 6660										
30 km/h	3580 3965 4355 4740 5130 5260 5385 5515 5645 5775 5905 6035 6420										
40 km/h	3350 3710 4075 4435 4795 4915 5035 5155 5275 5400 5520 5640 6000										
50 km/h	3350 3710 4075 4435 4795 4915 5035 5155 5275 5400 5520 5640 6000										

Ø inches	Description	CAI	e mm	D mm	R' mm	RC mm	Recommended Rim	Acceptable Rim	Tube (Code)	75% internal volume (litres)	Tread depth (mm)
38	650/85R38 173A8/173B TL <i>Textile belted</i>	173491	698.5	2048	931	6100	DW23B (A)	DW20B (A)	804	857	63
Bar	1 1.3 1.6 1.9 2.2 2.3 2.4 2.5 2.6 2.7 2.8										
Psi	15 19 23 28 32 33 35 36 38 39 41										
10 km/h	5815 6660 7500 8065 8625 8815 9000 9190 9375 9565 9750										
10 km/h Cyc Dual	5610 6545 7480 8040 8600 8790 8975 9165 9350 9535 9724										
25 km/h	4440 5245 6050 6485 6925 7070 7215										
30 km/h	4280 5055 5830 6250 6675 6815 6955										
40 km/h	4000 4725 5450 5845 6240 6370 6500										
50 km/h	4000 4725 5450 5845 6240 6370 6500										

Ø inches	Description	CAI	e mm	D mm	R' mm	RC mm	Recommended Rim	Acceptable Rim	Tube (Code)	75% internal volume (litres)	Tread depth (mm)
42	520/85R42 162A8/162B TL <i>Textile belted</i>	645194	537	1937	889	5783	DW18L	DD18 W18L	802	545	56
Bar	1 1.3 1.6 1.9 2.2 2.3 2.4 2.5 2.6 2.7										
Psi	15 19 23 28 32 33 35 36 38 39										
10 km/h	3990 4900 5810 6395 6830 6975 7070 7170 7265 7360										
10 km/h Cyc Dual	3850 4575 5300 6170 6500 6620 6740 6865 6985 7105										
25 km/h	3330 3955 4580 4890 5135 5205 5275										
30 km/h	3210 3815 4415 4715 4950 5020 5085										
30 km/h Dual	2825 3355 3885 4150 4355 4415 4475										
50 km/h	3000 3565 4125 4405 4625 4690 4750										

* Refer to the notes at the end of the tables of this range

MICHELIN MEGAXBIB

Tire specifications and pressure table (bar & psi). Load per tire in kg*

Ø inches	Description	CAI	e mm	D mm	R' mm	RC mm	Recommended Rim	Acceptable Rim	Tube (Code)	75% internal volume (litres)	Tread depth (mm)
42	620/70R42 166A8/166B TL <i>Textile belted</i>	100268	639	1961	885	5857	DW20B (A)	DW18L MW20B (A)	802	658	56
Bar	1 1.3 1.6	1.9	2.2	2.3	2.4	2.5	2.6	2.7	2.8		
Psi	15 19 23	28	32	33	35	36	38	39	41		
10 km/h	4090	4890	5685	6485	7050	7200	7350	7500	7650	7800	7950
10 km/h Cyc Dual	4080	4875	5670	6465	7030	7180	7330	7480	7630	7780	7930
30 km/h Dual	3060	3650	4240	4520	4805	4895	4990				
40 km/h	3250	3875	4500	4800	5100	5200	5300				
50 km/h	3250	3875	4500	4800	5100	5200	5300				

***IMPORTANT:**

The inflation pressure must always be appropriate for the load per tire, the speed of travel and the work to be done. Our recommendations above are provided subject to changes made after the date of publication of these tables (July 2020). Technical data is subject to change without prior notice.

- For standard or slope correction machines working on slopes of over 20% (11°), use the 10 km/h non-cyclic line
- For harvesters, use 10 km/h non-cyclic table and the 30 km/h non-cyclic table for floaters.
- Add 0.4 bar for intense road use exceeding 50% of time on road
- 10 km/h or 30 km/h cyclic load, use in the field only, travel with full load not to exceed 1,5 km.

ROW CROP



MICHELIN SPRAYBIB

**HIGH LOAD CAPACITY
FOR SPRAYERS**



FOR **SPRAYERS** AND **ROW CROP** APPLICATIONS



VERY HIGH FLEXION (VF)



PRODUCTIVITY

- +16%⁽¹⁾ load vs IF tire for the same pressure



SOIL PROTECTION

- 25%⁽¹⁾ lower air pressure for the same load as an IF tire



COMFORT

- Excellent stability at high speeds (up to 65 km/h)

(1) Internal test 2015 (Ladoux – France)

SIZES

VF 380/80R38 167D TL

VF 320/90R42 163D TL

VF 480/80R42 176D TL

VF 320/90R46 165D TL **NEW**

VF 380/90R46 173D TL

VF 480/80R46 177D TL

VF 320/90R50 166D TL

VF 380/90R50 175D TL

VF 480/80R50 179D TL

VF 420/95R50 177D TL

VF 320/90R54 168D TL

VF 380/90R54 176D TL

MICHELIN SPRAYBIB

Tire specifications and pressure table (bar & psi). Load per tire in kg*

Ø inches	Description	CAI	e mm	D mm	R' mm	RC mm	Recommended Rim	Acceptable Rim	Tube (Code)	75% internal volume (litres)	Tread depth (mm)
38	VF 380/80R38 167D TL	352109	382	1577	726	4712	DW13	DW12	795	231	38
Bar	1.8 2 2.2 2.4 2.6 2.8 3	3.2 3.4 3.6 3.8	4 4.2 4.4								
Psi	26 29 32 35 38 41 44	46 49 52 55	58 61 64								
65 km/h	3100 3375 3650 3750	3940 4125 4315 4500	4625 4750 4875 5000	5225 5450							

Ø inches	Description	CAI	e mm	D mm	R' mm	RC mm	Recommended Rim	Acceptable Rim	Tube (Code)	75% internal volume (litres)	Tread depth (mm)
42	VF 320/90R42 163D TL	920383	332	1635	758	4890	DW11	DW10		195	36
Bar	1.8 2 2.2 2.4 2.6 2.8 3	3.2 3.4 3.6 3.8	4 4.2 4.4								
Psi	26 29 32 35 38 41 44	46 49 52 55	58 61 64								
65 km/h	2815 3025 3250 3350	3500 3650 3825 4000	4125 4250 4405 4565	4720 4875							

Ø inches	Description	CAI	e mm	D mm	R' mm	RC mm	Recommended Rim	Acceptable Rim	Tube (Code)	75% internal volume (litres)	Tread depth (mm)
42	VF 480/80R42 176D TL	929553	489	1838	833	5471	DW16A	DD16 W16A	801	420	38
Bar	1.8 2 2.2 2.4 2.6 2.8 3	3.2 3.4 3.6									
Psi	26 29 32 35 38 41 44	46 49 52									
65 km/h	5000 5200 5400 5600	5875 6150 6425 6700	6900 7100								

Ø inches	Description	CAI	e mm	D mm	R' mm	RC mm	Recommended Rim	Acceptable Rim	Tube (Code)	75% internal volume (litres)	Tread depth (mm)
46	VF 320/90R46 165D TL NEW	684579	318	1736	810	5350	DW10		835	211	37
Bar	2.2 2.4 2.6 2.8 3 3.2 3.4 3.6 3.8	4 4.2 4.4									
Psi	32 35 38 41 44 46 49 52 55	58 61 64									
65 km/h	3450 3550 3715 3875	4000 4125 4315 4500	4665 4825 4990 5150								

Ø inches	Description	CAI	e mm	D mm	R' mm	RC mm	Recommended Rim	Acceptable Rim	Tube (Code)	75% internal volume (litres)	Tread depth (mm)
46	VF 380/90R46 173D TL	198604	383	1842	848	5530	DW13A	DW12A W12A W13A W13	835	308	38
Bar	1.8 2 2.2 2.4 2.6 2.8 3	3.2 3.4 3.6 3.8	4 4.2 4.4								
Psi	26 29 32 35 38 41 44	46 49 52 55	58 61 64								
65 km/h	3725 4050 4375 4625	4815 5000 5225 5450	5625 5800 5900 6000	6250 6500							

* Refer to the notes at the end of the tables of this range

MICHELIN SPRAYBIB

Tire specifications and pressure table (bar & psi). Load per tire in kg*

Ø inches	Description	CAI	e mm	D mm	R' mm	RC mm	Recommended Rim	Acceptable Rim	Tube (Code)	75% internal volume (litres)	Tread depth (mm)
46	VF 480/80R46 177D TL	159186	485	1943	885	5790	DW16A (L)	W16A DW15L DW16B	834	449	38
Bar	1.8 2 2.2 2.4 2.6 2.8 3 3.2 3.4 3.6										
Psi	26 29 32 35 38 41 44 46 49 52										
65 km/h	5300 5465 5635 5800 6075 6350 6625 6900 7100 7300										

Ø inches	Description	CAI	e mm	D mm	R' mm	RC mm	Recommended Rim	Acceptable Rim	Tube (Code)	75% internal volume (litres)	Tread depth (mm)
50	VF 320/90R50 166D TL	946508	330	1844	864	5531	DW11	DW10 W10 W11	816	240	37
Bar	1.8 2 2.2 2.4 2.6 2.8 3 3.2 3.4 3.6 3.8								4	4.2	4.4
Psi	26 29 32 35 38 41 44 46 49 52 55								58	61	64
65 km/h	3040 3300 3650 3750 3875 4000 4190 4375 4500 4625 4795 4965 5130 5300										

Ø inches	Description	CAI	e mm	D mm	R' mm	RC mm	Recommended Rim	Acceptable Rim	Tube (Code)	75% internal volume (litres)	Tread depth (mm)
50	VF 380/90R50 175D TL	722276	384	1951	903	5836	DW13B	DW12A W12A W13A W13B W12B		329	38
Bar	1.8 2 2.2 2.4 2.6 2.8 3 3.2 3.4 3.6 3.8								4	4.2	4.4
Psi	26 29 32 35 38 41 44 46 49 52 55								58	61	64
65 km/h	3950 4300 4625 4750 4950 5150 5375 5600 5800 6000 6150 6300 6600 6900										

Ø inches	Description	CAI	e mm	D mm	R' mm	RC mm	Recommended Rim	Acceptable Rim	Tube (Code)	75% internal volume (litres)	Tread depth (mm)
50	VF 480/80R50 179D TL	431251	485	2045	935	6101	DW16A(L)	DW15L DW15B (A) W15B (A) DW16B W16B		479	38
Bar	1.8 2 2.2 2.4 2.6 2.8 3 3.2 3.4 3.6										
Psi	26 29 32 35 38 41 44 46 49 52										
65 km/h	5450 5685 5915 6150 6440 6725 7015 7300 7525 7750										

Ø inches	Description	CAI	e mm	D mm	R' mm	RC mm	Recommended Rim	Acceptable Rim	Tube (Code)	75% internal volume (litres)	Tread depth (mm)
50	VF 420/95R50 177D TL	085405	423	2052	937	6118	DW14B (A)	DW13B (A) W13B (A) W14B (A)		440	38
Bar	1.8 2 2.2 2.4 2.6 2.8 3 3.2 3.4 3.6										
Psi	26 29 32 35 38 41 44 46 49 52										
65 km/h	5150 5365 5585 5800 6075 6350 6625 6900 7100 7300										

* Refer to the notes at the end of the tables of this range

MICHELIN SPRAYBIB

Tire specifications and pressure table (bar & psi). Load per tire in kg*

Ø inches	Description	CAI	e mm	D mm	R' mm	RC mm	Recommended Rim	Acceptable Rim	Tube (Code)	75% internal volume (litres)	Tread depth (mm)
54	VF 320/90R54 168D TL	044008	327	1950	909	5843	DW11	DW10 W10 W11	816	240	36
Bar	1.8 2 2.2 2.4	2.6 2.8 3	3.2 3.4 3.6 3.8	4	4.2 4.4						
Psi	26 29 32 35	38 41 44	46 49 52 55	58	61 64						
65 km/h	3225 3500 3750 3875	4065 4250 4440	4625 4750 4875 5055	5240	5420 5600						

Ø inches	Description	CAI	e mm	D mm	R' mm	RC mm	Recommended Rim	Acceptable Rim	Tube (Code)	75% internal volume (litres)	Tread depth (mm)
54	VF 380/90R54 176D TL	816598	384	2049	950	6131	DW13A	W12A		350	37
Bar	1.8 2 2.2 2.4	2.6 2.8 3	3.2 3.4 3.6 3.8	4	4.2 4.4						
Psi	26 29 32 35	38 41 44	46 49 52 55	58	61 64						
65 km/h	4175 4525 4875 5000	5190 5375 5565	5750 5940 6125 6315	6500	6800 7100						

***IMPORTANT:**

The inflation pressure must always be appropriate for the load per tire, the speed of travel and the work to be done. Our recommendations above are provided subject to changes made after the date of publication of these tables (July 2020). Technical data is subject to change without prior notice.

- Add 0.4 bar for use on slopes of more than 20%
- Add 0.4 bar for intense road use exceeding 50% of time on road

ROW CROP



MICHELIN AGRIBIB ROW CROP

**SPECIALLY DESIGNED FOR
ROW CROP WORK WITH
EXCELLENT TRACTION**



FOR ROW CROP TRACTORS AND IMPLEMENTS



TRACTION



CROP PROTECTION

SIZES

320/85R38 143A8/143B TL

320/90R42 147A8/147B TL

340/85R46 150A8/150B TL

380/90R46 157A8/157B TL

320/90R50 150A8/150B TL

380/90R50 151A8/151B TL

IF 380/90R50 167A8/167B TL **NEW**

320/90R54 151A8/151B TL

MICHELIN AGRIBIB ROW CROP

Tire specifications and pressure table (bar & psi). Load per tire in kg*

Ø inches	Description	CAI	e mm	D mm	R' mm	RC mm	Recommended Rim		Acceptable Rim		Tube (Code)	75% internal volume (litres)	Tread depth (mm)		
38	320/85R38 143A8/143B TL	758001	315	1508	699	4514	W10		DW10A DW11A W11		779	170	42		
Bar	1.2	1.4	1.6	1.8	2	2.2	2.4	2.6	2.8	3	3.2	3.4	3.6	3.8	4
Psi	17	20	23	26	29	32	35	38	41	44	46	49	52	55	58
10 km/h Cyc			2330	2520	2710	2900	3090	3205	3315	3430	3540	3700	3860	3975	4090
25 km/h	1720	1885	2050	2145	2235	2330	2420	2530	2640	2750	2860	2940	3020		
25 km/h Cyc	1890	2075	2260	2360	2460	2560	2660	2780	2900	3020	3140	3230	3320		
30 km/h	1660	1820	1980	2070	2155	2245	2330	2440	2545	2655	2760	2840	2920		
30 km/h Cyc	1770	1940	2110	2205	2300	2395	2490	2605	2715	2830	2940	3025	3110		
50 km/h	1550	1700	1850	1935	2015	2100	2180	2280	2380	2475	2575	2650	2725		

Ø inches	Description	CAI	e mm	D mm	R' mm	RC mm	Recommended Rim		Acceptable Rim		Tube (Code)	75% internal volume (litres)	Tread depth (mm)		
42	320/90R42 147A8/147B TL	425361	312	1638	764	4908	DW10L		W10L W9L			197	42		
Bar	1.2	1.4	1.6	1.8	2	2.2	2.4	2.6	2.8	3	3.2	3.4	3.6	3.8	4
Psi	17	20	23	26	29	32	35	38	41	44	46	49	52	55	58
10 km/h Cyc			2850	3025	3195	3370	3540	3650	3760	3865	3975	4165	4350	4480	4610
25 km/h	1890	2090	2290	2395	2495	2600	2700	2830	2960	3090	3220	3320	3415		
25 km/h Cyc	2075	2295	2510	2625	2740	2850	2965	3110	3255	3395	3540	3645	3750		
30 km/h	1820	2010	2200	2300	2400	2500	2600	2725	2850	2975	3100	3195	3290		
30 km/h Cyc	1940	2225	2510	2575	2640	2705	2770	2905	3040	3170	3305	3405	3505		
50 km/h	1700	1880	2060	2155	2245	2340	2430	2550	2665	2785	2900	2990	3075		

Ø inches	Description	CAI	e mm	D mm	R' mm	RC mm	Recommended Rim		Acceptable Rim		Tube (Code)	75% internal volume (litres)	Tread depth (mm)		
46	340/85R46 150A8/150B TL	846786	338	1747	810	5227	W12		DW10A W10 W12A		835	225	41		
Bar	1.2	1.4	1.6	1.8	2	2.2	2.4	2.6	2.8	3	3.2	3.4	3.6	3.8	4
Psi	17	20	23	26	29	32	35	38	41	44	46	49	52	55	58
10 km/h Cyc			2780	3025	3265	3510	3750	3900	4050	4200	4350	4540	4730	4880	5030
25 km/h	2050	2270	2490	2605	2715	2830	2940	3080	3220	3360	3500	3610	3720		
25 km/h Cyc	2260	2495	2730	2855	2980	3105	3230	3385	3535	3690	3840	3965	4090		
30 km/h	1980	2190	2400	2510	2620	2730	2840	2975	3105	3240	3370	3475	3580		
30 km/h Cyc	2110	2330	2550	2670	2785	2905	3020	3165	3305	3450	3590	3705	3820		
50 km/h	1850	2045	2240	2345	2445	2550	2650	2775	2900	3025	3150	3250	3350		

* Refer to the notes at the end of the tables of this range

MICHELIN AGRIBIB ROW CROP

Tire specifications and pressure table (bar & psi). Load per tire in kg*

Ø inches	Description	CAI	e mm	D mm	R' mm	RC mm	Recommended Rim	Acceptable Rim	Tube (Code)	75% internal volume (litres)	Tread depth (mm)				
46	380/90R46 157A8/157B TL	799905	401	1864	867	5583	W13A	W12A W12 DW13A DW13 W13	835	308	46				
Bar	1.2	1.4	1.6	1.8	2	2.2	2.4	2.6	2.8	3	3.2	3.4	3.6	3.8	4
Psi	17	20	23	26	29	32	35	38	41	44	46	49	52	55	58
10 km/h Cyc			3450	3740	4030	4320	4610	4790	4970	5150	5330	5570	5810	6000	6190
25 km/h	2550	2830	3110	3235	3360	3485	3610	3785	3955	4130	4300	4440	4580		
25 km/h Cyc	2810	3115	3420	3560	3695	3835	3970	4160	4350	4540	4730	4880	5030		
30 km/h	2460	2730	3000	3120	3240	3360	3480	3650	3815	3985	4150	4280	4410		
30 km/h Cyc	2620	2905	3190	3320	3450	3580	3710	3890	4065	4245	4420	4560	4700		
50 km/h	2300	2550	2800	2915	3025	3140	3250	3405	3565	3720	3875	4000	4125		

Ø inches	Description	CAI	e mm	D mm	R' mm	RC mm	Recommended Rim	Acceptable Rim	Tube (Code)	75% internal volume (litres)	Tread depth (mm)				
50	320/90R50 150A8/150B TL	130813	314	1847	862	5539	W10	DW10A W10A	816	226	39				
Bar	1.2	1.4	1.6	1.8	2	2.2	2.4	2.6	2.8	3	3.2	3.4	3.6	3.8	4
Psi	17	20	23	26	29	32	35	38	41	44	46	49	52	55	58
10 km/h Cyc			2780	3025	3265	3510	3750	3900	4050	4200	4350	4540	4730	4880	5030
25 km/h	2050	2270	2490	2605	2715	2830	2940	3080	3220	3360	3500	3610	3720		
25 km/h Cyc	2260	2495	2730	2855	2980	3105	3230	3385	3535	3690	3840	3965	4090		
30 km/h	1980	2190	2400	2510	2620	2730	2840	2975	3105	3240	3370	3475	3580		
30 km/h Cyc	2110	2330	2550	2670	2785	2905	3020	3165	3305	3450	3590	3705	3820		
50 km/h	1850	2045	2240	2345	2445	2550	2650	2775	2900	3025	3150	3250	3350		

Ø inches	Description	CAI	e mm	D mm	R' mm	RC mm	Recommended Rim	Acceptable Rim	Tube (Code)	75% internal volume (litres)	Tread depth (mm)
50	380/90R50 151A8/151B TL	036849	393	1935	912	5813	DW13A	DW12A W12A W13A		329	47
Bar	1.2	1.4	1.6	1.8	2	2.2	2.4	2.6	2.8		
Psi	17	20	23	26	29	32	35	38	41		
10 km/h Cyc			3540	3945	4350	4555	4765	4970	5175		
25 km/h	2620	2920	3220	3375	3525	3680	3830				
25 km/h Cyc	2880	3210	3540	3710	3875	4045	4210				
30 km/h	2525	2815	3100	3250	3395	3545	3690				
30 km/h Cyc	2690	3000	3305	3465	3620	3780	3935				
50 km/h	2360	2630	2900	3040	3175	3315	3450				

* Refer to the notes at the end of the tables of this range

MICHELIN AGRIBIB ROW CROP

Tire specifications and pressure table (bar & psi). Load per tire in kg*

Ø inches	Description	CAI	e mm	D mm	R' mm	RC mm	Recommended Rim		Acceptable Rim		Tube (Code)	75% internal volume (litres)		Tread depth (mm)	
50	IF 380/90R50 167A8/167B TL NEW	212359	395	1953	903	5841	DW13A		DW12A W12A W13A			329		47	
Bar	1.2	1.4	1.6	1.8	2	2.2	2.4	2.6	2.8	3	3.2	3.4	3.6	3.8	4
Psi	17	20	23	26	29	32	35	38	41	44	46	49	52	55	58
10 km/h	3200	3500	3800	4040	4275	4415	4550	4750	4950	5165	5375	5525	5675	5840	6000
20 km/h	3125	3425	3725	3950	4175	4315	4450	4650	4850	5065	5275	5415	5550	5715	5875
30 km/h	3025	3315	3600	3815	4025	4165	4300	4490	4675	4875	5075	5215	5350	5515	5675
50 km/h	2900	3175	3450	3665	3875	4000	4125	4315	4500	4690	4875	5015	5150	5300	5450

Ø inches	Description	CAI	e mm	D mm	R' mm	RC mm	Recommended Rim		Acceptable Rim		Tube (Code)	75% internal volume (litres)		Tread depth (mm)		
54	320/90R54 151A8/151B TL	272304	315	1950	915	5852	W10		DW11 W11		816	240		39		
Bar	1.2	1.4	1.6	1.8	2	2.2	2.4	2.6	2.8	3	3.2	3.4	3.6	3.8	4	
Psi	17	20	23	26	29	32	35	38	41	44	46	49	52	55	58	
10 km/h Cyc				2930	3165	3395	3630	3860	4020	4180	4340	4500	4690	4880	5030	5180
25 km/h	2160	2390	2620	2720	2820	2920	3020	3170	3315	3465	3610	3720	3830			
25 km/h Cyc	2380	2630	2880	2990	3100	3210	3320	3485	3645	3810	3970	4090	4210			
30 km/h	2090	2310	2530	2630	2725	2825	2920	3060	3200	3340	3480	3585	3690			
30 km/h Cyc	2220	2455	2690	2795	2900	3005	3110	3260	3410	3560	3710	3820	3930			
50 km/h	1950	2155	2360	2450	2545	2635	2725	2855	2990	3120	3250	3350	3450			

***IMPORTANT:**

The inflation pressure must always be appropriate for the load per tire, the speed of travel and the work to be done. Our recommendations above are provided subject to changes made after the date of publication of these tables (July 2020). Technical data is subject to change without prior notice.

- Add 0.4 bar for use on slopes of more than 20% without exceeding the max. tire pressure.
- Add 0.4 bar for intense road use exceeding 50% of time on road
- Use 10, 25 or 30 km/h cyclic loading tables for field use only, travel with full load not to exceed 1,5 km



NEW

MICHELIN TRAILXBIB

OPTIMUM LONGEVITY FOR YOUR TRAILER TIRES



VF MICHELIN ULTRAFLEX TECHNOLOGY

- Low soil compaction
- Optimized yields



OUTSTANDING ENDURANCE

- New VF casing designed for robustness and low pressure impact
- Steel reinforced tread



SELF-CLEANING

- Specific tread pattern design
- Wide and divergent inter-lugs



DESIGNED FOR A LONG TIRE LIFE

- Limited scrub thanks to high clearance angle
- More rubber to be worn



EXCELLENT ROAD HANDLING

- Central RIB for robustness
- CTIS compatibility for optimized pressure on the road and in the field

SIZES

- VF 560/60R22.5 IMP 166D TL **NEW**
- VF 650/55R26.5 IMP 174D TL **NEW**

MICHELIN TRAILXBIB

Tire specifications and pressure table (bar & psi). Load per tire in kg*

Ø inches	Description	CAI	e mm	D mm	R' mm	RC mm	Recommended Rim		Acceptable Rim		Tube (Code)	75% internal volume (litres)	Tread depth (mm)
22.5	VF 560/60R22.5 IMP 166D TL NEW	103824	542	1242	507	3612	AG16.00 (H2)		16.00 AG20.00 (H2) 17.00 AG18.00			263	19
Bar	0.8	0.9	1	1.2	1.5	1.8	2.1	2.4	2.7	3	3.2		
Psi	12	13	15	17	22	26	30	35	39	44	46		
10 km/h	3725	3975	4250	4775	5575	6375	6950	7050	7750	8400	8700		
25 km/h	3300	3550	3775	4250	4950	5675	6200	6275	6900	7475	7750		
40 km/h	2925	3125	3350	3750	4375	5000	5475	5550	6100	6600	6825		
50 km/h	2650	2850	3025	3400	3975	4550	4975	5025	5525	6000	6200		
65 km/h	2275	2440	2600	2925	3400	3825	4250	4300	4725	5125	5300		

Ø inches	Description	CAI	e mm	D mm	R' mm	RC mm	Recommended Rim		Acceptable Rim		Tube (Code)	75% internal volume (litres)	Tread depth (mm)
26.5	VF 650/55R26.5 IMP 174D TL NEW	054878	649	1402	575	4082	AG20.00 (H2)					377	23
Bar	0.8	0.9	1	1.2	1.5	1.8	2.1	2.4	2.7	3	3.2		
Psi	12	13	15	17	22	26	30	35	39	44	46		
10 km/h	4223	4572	4920	5494	6355	7175	8021	8938	9799	10660	10988		
25 km/h	3760	4070	4380	4891	5658	6388	7140	7957	8724	9490	9782		
40 km/h	3322	3596	3870	4322	4999	5644	6309	7031	7708	8385	8643		
50 km/h	3013	3261	3510	3919	4534	5119	5722	6377	6991	7605	7839		
65 km/h	2575	2770	2965	3350	3875	4325	4830	5450	5975	6500	6700		

***IMPORTANT:**

The inflation pressure must always be appropriate for the load per tire, the speed of travel and the work to be done. Our recommendations above are provided subject to changes made after the date of publication of these tables (July 2020). Technical data is subject to change without prior notice.

- Add 0.4 bar for use on slopes of more than 20%
- Add 0.4 bar for intense road use exceeding 50% of time on road



MICHELIN CARGOXBIB HIGH FLOTATION

THE LOW-PRESSURE
TRAILER TIRE WITH
LESS IMPACT ON THE SOIL



The best performance **FROM ROAD TO FIELD**



SOIL PROTECTION

thanks to low pressure from 0,8 bar and +37% footprint⁽¹⁾



Up to 3 times more **SELF-CLEANING ABILITY**



Excellent **ROAD HANDLING**



STEEL REINFORCED TREAD

- Great stability
- Excellent puncture resistance and better load distribution.

(1) Internal studies at Michelin's Technology Centre April 2012 / June 2013

SIZES

710/45R22.5 165D TL

28LR26 175D TL

600/55R26.5 165D TL

VF 600/55R26.5 IMP 170D TL

710/50R26.5 170D TL

VF 710/50R26.5 IMP 176D TL

650/55R26.5 169D TL

VF 650/55R26.5 IMP 174D TL

650/65R30.5 176D TL

VF 750/60R30.5 IMP 187D TL

750/60R30.5 181D TL

800/60R32 IMP 185D TL

MICHELIN CARGOXBIB HIGH FLOTATION

Tire specifications and pressure table (bar & psi). Load per tire in kg*

Ø inches	Description	CAI	e mm	D mm	R' mm	RC mm	Recommended Rim	Acceptable Rim	Tube (Code)	75% internal volume (litres)	Tread depth (mm)				
22.5	710/45R22.5 165D TL	723051	723	1208	514	3545	AG24.00 (H2)	AG20.00 (H2)		317	16				
Bar	0.8	0.9	1	1.2	1.5	1.8	2.1	2.4	2.7	3	3.2	3.4	3.6	3.8	4
Psi	12	13	15	17	22	26	30	35	39	44	46	49	52	55	58
10 km/h	2970	3430	3890	4325	4970	5620	6270	6920	7360	7800	8095	8390	8685	8975	9270
25 km/h	2610	2930	3250	3650	4255	4855	5460	6060	6450	6840	7100	7360	7620	7880	8140
40 km/h	2250	2525	2800	3145	3665	4185	4700	5220	5555	5890	6110	6335	6555	6780	7000
50 km/h	2000	2245	2490	2795	3260	3720	4180	4640	4940	5235	5435	5635	5835	6030	6230
65 km/h	1650	1855	2060	2315	2695	3075	3460	3840	4085	4330	4495	4660	4825	4985	5150

Ø inches	Description	CAI	e mm	D mm	R' mm	RC mm	Recommended Rim	Acceptable Rim	Tube (Code)	75% internal volume (litres)	Tread depth (mm)				
26	28LR26 175D TL	224829	740	1581	705	4685	DW25B (A)	DW23B(A)		578	26				
Bar	0.8	0.9	1	1.2	1.5	1.8	2.1	2.4	2.7	3	3.2	3.4	3.6	3.8	4
Psi	12	13	15	17	22	26	30	35	39	44	46	49	52	55	58
15 km/h	3750	3935	4120	4615	5360	5905	6460	7035	7605	7905	8140	8375	8710	8980	9245
25 km/h	3320	3485	3645	4085	4740	5220	5710	6220	6725	6990	7200	7405	7705	7940	8175
40 km/h	3065	3215	3365	3770	4380	4825	5280	5750	6215	6460	6655	6845	7120	7340	7555
50 km/h	2940	3085	3230	3620	4200	4625	5060	5515	5960	6195	6380	6565	6825	7035	7245
65 km/h	2800	2940	3075	3445	4000	4405	4820	5250	5675	5900	6075	6250	6500	6700	6900

Ø inches	Description	CAI	e mm	D mm	R' mm	RC mm	Recommended Rim	Acceptable Rim	Tube (Code)	75% internal volume (litres)	Tread depth (mm)				
26.5	600/55R26.5 165D TL	550621	626	1341	581	3954	AG20.00 (H2)		716	312	17				
Bar	0.8	0.9	1	1.2	1.5	1.8	2.1	2.4	2.7	3	3.2	3.4	3.6	3.8	4
Psi	12	13	15	17	22	26	30	35	39	44	46	49	52	55	58
10 km/h	2970	3585	4200	4675	5380	6090	6800	7510	7840	8170	8390	8610	8830	9050	9270
25 km/h	2610	3085	3560	3995	4640	5290	5940	6590	6880	7170	7365	7560	7755	7945	8140
40 km/h	2250	2675	3100	3465	4020	4570	5120	5670	5920	6170	6335	6500	6670	6835	7000
50 km/h	2000	2375	2750	3080	3570	4065	4555	5050	5270	5495	5640	5790	5935	6085	6230
65 km/h	1650	1975	2300	2565	2970	3370	3770	4170	4355	4540	4660	4785	4905	5030	5150

Ø inches	Description	CAI	e mm	D mm	R' mm	RC mm	Recommended Rim	Acceptable Rim	Tube (Code)	75% internal volume (litres)	Tread depth (mm)				
26.5	VF 600/55R26.5 IMP 170D TL	377726	626	1341	562	3923	AG20.00 (H2)			312	17				
Bar	0.8	0.9	1	1.2	1.5	1.8	2.1	2.4	2.7	3	3.2				
Psi	12	13	15	17	22	26	30	35	39	44	46				
10 km/h	3772	4025	4264	4756	5658	6322	7081	7790	8549	9184	9840				
25 km/h	3358	3583	3796	4234	5037	5628	6304	6935	7610	8176	8760				
40 km/h	2967	3166	3354	3741	4451	4973	5570	6128	6724	7224	7740				
50 km/h	2691	2871	3042	3393	4036	4510	5051	5558	6099	6552	7020				
65 km/h	2300	2450	2600	2900	3450	3855	4280	4750	5275	5600	6000				

* Refer to the notes at the end of the tables of this range

MICHELIN CARGOXBIB HIGH FLOTATION

Tire specifications and pressure table (bar & psi). Load per tire in kg*

Ø inches	Description	CAI	e mm	D mm	R' mm	RC mm	Recommended Rim	Acceptable Rim	Tube (Code)	75% internal volume (litres)	Tread depth (mm)				
26.5	710/50R26.5 170D TL	892516	729	1380	594	4061	AG24.00 (H2)	AG20.00 (H2)		407	18				
Bar	0.8	0.9	1	1.2	1.5	1.8	2.1	2.4	3	3.2	3.4	3.6	3.8	4	
Psi	12	13	15	17	22	26	30	35	39	44	46	49	52	55	58
10 km/h	3510	4205	4900	5450	6275	7100	7925	8750	9135	9520	9775	10030	10290	10545	10800
25 km/h	3080	3610	4140	4645	5400	6155	6915	7670	8010	8350	8575	8800	9030	9255	9480
40 km/h	2650	3130	3610	4040	4680	5325	5965	6610	6900	7190	7385	7580	7775	7965	8160
50 km/h	2360	2780	3200	3585	4155	4730	5305	5880	6140	6400	6570	6745	6915	7090	7260
65 km/h	1950	2315	2680	2990	3460	3925	4395	4860	5075	5290	5430	5575	5715	5860	6000

Ø inches	Description	CAI	e mm	D mm	R' mm	RC mm	Recommended Rim	Acceptable Rim	Tube (Code)	75% internal volume (litres)	Tread depth (mm)
26.5	VF 710/50R26.5 IMP 176D TL	343405	729	1380	568	4022	AG24.00 (H2)	AG20.00 (H2)		407	18
Bar	0.8	0.9	1	1.2	1.5	1.8	2.1	2.4	3	3.2	
Psi	12	13	15	17	22	26	30	35	39	44	46
10 km/h	4469	4768	5150	5822	6765	7503	8400	9184	10081	10988	11644
25 km/h	3979	4245	4584	5183	6023	6680	7478	8176	8974	9782	10366
40 km/h	3515	3750	4051	4580	5321	5902	6607	7224	7929	8643	9159
50 km/h	3188	3402	3674	4154	4826	5353	5993	6552	7192	7839	8307
65 km/h	2725	2930	3140	3550	4125	4575	5055	5600	6275	6700	7100

Ø inches	Description	CAI	e mm	D mm	R' mm	RC mm	Recommended Rim	Acceptable Rim	Tube (Code)	75% internal volume (litres)	Tread depth (mm)				
26.5	650/55R26.5 169D TL	693431	657	1402	617	4158	AG20.00 (H2)		716	437	18				
Bar	0.8	0.9	1	1.2	1.5	1.8	2.1	2.4	3	3.2	3.4	3.6	3.8	4	
Psi	12	13	15	17	22	26	30	35	39	44	46	49	52	55	58
10 km/h	3330	3985	4635	5220	6100	6875	7600	8325	8780	9235	9540	9765	9990	10215	10440
25 km/h	2925	3500	4070	4585	5355	6035	6675	7310	7710	8110	8375	8575	8770	8970	9165
40 km/h	2515	3010	3500	3945	4610	5195	5745	6290	6635	6980	7210	7380	7550	7720	7890
50 km/h	2240	2680	3115	3510	4100	4620	5110	5595	5905	6210	6415	6565	6720	6870	7020
65 km/h	1850	2215	2575	2900	3390	3820	4220	4625	4880	5130	5300	5425	5550	5675	5800

Ø inches	Description	CAI	e mm	D mm	R' mm	RC mm	Recommended Rim	Acceptable Rim	Tube (Code)	75% internal volume (litres)	Tread depth (mm)
26.5	VF 650/55R26.5 IMP 174D TL	776393	663	1402	578	4084	AG20.00	AG20.00 (H2)		437	18
Bar	0.8	0.9	1	1.2	1.5	1.8	2.1	2.4	3	3.2	
Psi	12	13	15	17	22	26	30	35	39	44	46
10 km/h	4223	4572	4920	5494	6355	7175	8021	8938	9799	10660	10988
25 km/h	3760	4070	4380	4891	5658	6388	7140	7957	8724	9490	9782
40 km/h	3322	3596	3870	4322	4999	5644	6309	7031	7708	8385	8643
50 km/h	3013	3261	3510	3919	4534	5119	5722	6377	6991	7605	7839
65 km/h	2575	2770	2965	3350	3875	4325	4830	5450	5975	6500	6700

* Refer to the notes at the end of the tables of this range

MICHELIN CARGOXBIB HIGH FLOTATION

Tire specifications and pressure table (bar & psi). Load per tire in kg*

Ø inches	Description	CAI	e mm	D mm	R' mm	RC mm	Recommended Rim	Acceptable Rim	Tube (Code)	75% internal volume (litres)	Tread depth (mm)				
30.5	650/65R30.5 176D TL	139310	674	1622	699	4776	AG20.00 (H2)			600	21				
Bar	0.8	0.9	1	1.2	1.5	1.8	2.1	2.4	2.7	3	3.2	3.4	3.6	3.8	4
Psi	12	13	15	17	22	26	30	35	39	44	46	49	52	55	58
10 km/h	4140	4970	5800	6450	7430	8405	9385	10360	10815	11270	11570	11875	12175	12480	12780
25 km/h	3640	4270	4900	5495	6395	7290	8185	9080	9480	9885	10150	10420	10685	10955	11220
40 km/h	3130	3705	4280	4785	5545	6305	7060	7820	8165	8510	8740	8970	9200	9430	9660
50 km/h	2780	3285	3790	4245	4920	5600	6280	6960	7265	7570	7775	7980	8185	8385	8590
65 km/h	2300	2735	3170	3540	4090	4645	5195	5750	6005	6255	6425	6595	6765	6930	7100

Ø inches	Description	CAI	e mm	D mm	R' mm	RC mm	Recommended Rim	Acceptable Rim	Tube (Code)	75% internal volume (litres)	Tread depth (mm)
30.5	VF 750/60R30.5 IMP 187D TL	139588	780	1674	687	4875	AG24.00 (H2)			750	21
Bar	0.8	0.9	1.0	1.2	1.5	1.8	2.1	2.4	2.7	3.0	3.2
Psi	12	13	15	17	22	26	30	35	39	44	46
10 km/h	6150	6560	6970	7790	9184	10266	11496	12710	13940	15170	15990
25 km/h	5475	5840	6205	6935	8176	9140	10235	11315	12410	13505	14235
40 km/h	4838	5160	5483	6128	7224	8075	9043	9998	10965	11933	12578
50 km/h	4388	4680	4973	5558	6552	7324	8202	9068	9945	10823	11408
65 km/h	3750	4000	4250	4750	5600	6260	6965	7750	8500	9250	9750

Ø inches	Description	CAI	e mm	D mm	R' mm	RC mm	Recommended Rim	Acceptable Rim	Tube (Code)	75% internal volume (litres)	Tread depth (mm)				
30.5	750/60R30.5 181D TL	101332	786	1675	716	4936	AG24.00 (H2)			750	22				
Bar	0.8	0.9	1	1.2	1.5	1.8	2.1	2.4	2.7	3	3.2	3.4	3.6	3.8	4
Psi	12	13	15	17	22	26	30	35	39	44	46	49	52	55	58
10 km/h	4770	5750	6730	7490	8625	9765	10900	12040	12565	13095	13445	13795	14150	14500	14850
25 km/h	4185	4945	5700	6395	7430	8470	9510	10550	11015	11485	11795	12105	12420	12730	13040
40 km/h	3605	4290	4970	5560	6440	7325	8205	9090	9490	9890	10155	10420	10690	10955	11220
50 km/h	3205	3810	4410	4935	5720	6505	7295	8080	8435	8795	9030	9270	9505	9745	9980
65 km/h	2650	3165	3680	4110	4750	5395	6035	6680	6975	7270	7465	7660	7860	8055	8250

* Refer to the notes at the end of the tables of this range

MICHELIN CARGOXBIB HIGH FLOTATION

Tire specifications and pressure table (bar & psi). Load per tire in kg*

Ø inches	Description				CAI	e mm	D mm	R' mm	RC mm	Recommended Rim		Acceptable Rim		Tube (Code)	75% internal volume (litres)		Tread depth (mm)
32	800/60R32 IMP 185D TL				322432	818	1800	777	5300	DW27B (A)		DW25B (A)		831	900		23.5
Bar	0.8	0.9	1	1.2	1.5	1.8	2.1	2.4	2.7	3	3.2	3.4	3.6	3.8	4		
Psi	12	13	15	17	22	26	30	35	39	44	46	49	52	55	58		
10 km/h	5400	6525	7650	8580	9975	11205	12355	13500	14345	15190	15750	15975	16200	16425	16650		
25 km/h	4740	5730	6715	7530	8755	9835	10845	11850	12590	13330	13825	14025	14220	14420	14615		
40 km/h	4080	4930	5780	6485	7540	8470	9335	10200	10840	11475	11900	12070	12240	12410	12580		
50 km/h	3630	4390	5145	5770	6710	7535	8305	9075	9645	10210	10590	10740	10895	11045	11195		
65 km/h	3000	3625	4250	4765	5540	6225	6865	7500	7970	8440	8750	8875	9000	9125	9250		

***IMPORTANT:**

The inflation pressure must always be appropriate for the load per tire, the speed of travel and the work to be done. Our recommendations above are provided subject to changes made after the date of publication of these tables (July 2020). Technical data is subject to change without prior notice.

- Add 0.4 bar for use on slopes of more than 20%
- Add 0.4 bar for intense road use exceeding 50% of time on road



MICHELIN CARGOXBIB HEAVY DUTY

**EXCELLENT VALUE
FOR TRANSPORTING
YOUR HARVESTS**



Up to 3 times more **SELF-CLEANING ABILITY**



STABILITY

- Excellent road handling



SERVICE LIFE

- Proven casing endurance



STEEL REINFORCED TREAD

- Great stability
- Excellent puncture resistance and better load distribution.

SIZES

560/45R22.5 152D TL

500/60R22.5 155D TL

560/60R22.5 161D TL

MICHELIN CARGOXBIB HEAVY DUTY

Tire specifications and pressure table (bar & psi). Load per tire in kg*

Ø inches	Description	CAI	e mm	D mm	R' mm	RC mm	Recommended Rim	Acceptable Rim	Tube (Code)	75% internal volume (litres)	Tread depth (mm)				
22.5	560/45R22.5 152D TL	743789	535	1080	474	3191	AG16.00 (H2)			182	16				
Bar	0.8 0.9 1	1.2 1.5 1.8 2.1 2.4 2.7	3 3.2 3.4 3.6 3.8 4												
Psi	12 13 15	17 22 26 30 35 39	44 46 49 52 55 58												
10 km/h	2070	2225	2375	2665	3095	3475	3845	4245	4650	5050	5320	5585	5855	6120	6390
25 km/h	1820	1955	2085	2340	2720	3050	3375	3725	4080	4435	4670	4905	5140	5375	5610
40 km/h	1565	1680	1795	2015	2340	2625	2900	3205	3510	3815	4020	4220	4425	4625	4830
50 km/h	1390	1495	1600	1795	2085	2340	2585	2855	3125	3400	3580	3760	3940	4120	4300
65 km/h	1150	1235	1320	1480	1720	1930	2135	2360	2580	2805	2955	3105	3250	3400	3550

Ø inches	Description	CAI	e mm	D mm	R' mm	RC mm	Recommended Rim	Acceptable Rim	Tube (Code)	75% internal volume (litres)	Tread depth (mm)				
22.5	500/60R22.5 155D TL	441880	505	1172	508	3454	AG16.00 (H2)	16.00 14.00 15.00 17.00		206	16				
Bar	0.8 0.9 1	1.2 1.5 1.8 2.1 2.4 2.7	3 3.2 3.4 3.6 3.8 4												
Psi	12 13 15	17 22 26 30 35 39	44 46 49 52 55 58												
10 km/h	2250	2705	3160	3515	4050	4585	5115	5650	5900	6150	6315	6480	6650	6815	6980
25 km/h	1975	2330	2680	3005	3495	3985	4470	4960	5180	5395	5540	5685	5830	5975	6120
40 km/h	1700	2015	2330	2605	3025	3440	3855	4270	4460	4645	4770	4895	5020	5145	5270
50 km/h	1510	1790	2070	2315	2690	3060	3430	3800	3965	4135	4245	4355	4470	4580	4690
65 km/h	1250	1490	1730	1930	2235	2535	2840	3140	3280	3420	3510	3605	3695	3790	3880

Ø inches	Description	CAI	e mm	D mm	R' mm	RC mm	Recommended Rim	Acceptable Rim	Tube (Code)	75% internal volume (litres)	Tread depth (mm)				
22.5	560/60R22.5 161D TL	102433	543	1242	532	3650	AG16.00 (H2)	16.00 AG20.00 (H2) 17.00 AG18.00		269	16				
Bar	0.8 0.9 1	1.2 1.5 1.8 2.1 2.4 2.7	3 3.2 3.4 3.6 3.8 4												
Psi	12 13 15	17 22 26 30 35 39	44 46 49 52 55 58												
10 km/h	2700	3240	3780	4205	4840	5475	6115	6750	7045	7345	7540	7740	7935	8135	8330
25 km/h	2370	2780	3190	3580	4160	4745	5325	5910	6175	6435	6610	6785	6960	7135	7310
40 km/h	2040	2415	2790	3120	3610	4105	4595	5090	5315	5540	5690	5840	5990	6140	6290
50 km/h	1810	2140	2470	2765	3205	3645	4090	4530	4730	4930	5065	5200	5335	5465	5600
65 km/h	1500	1785	2070	2310	2670	3030	3390	3750	3915	4080	4190	4300	4410	4520	4630

***IMPORTANT:**

The inflation pressure must always be appropriate for the load per tire, the speed of travel and the work to be done. Our recommendations above are provided subject to changes made after the date of publication of these tables (July 2020). Technical data is subject to change without prior notice.

- Add 0.4 bar for use on slopes of more than 20%
- Add 0.4 bar for intense road use exceeding 50% of time on road



MICHELIN CARGOXBIB

**ENHANCED ENDURANCE
FOR HEAVY LOADS
AT LOW PRESSURES**



ENDURANCE



PRODUCTIVITY



PROFITABILITY



STEEL REINFORCED TREAD

- Great stability
- Excellent puncture resistance and better load distribution.

SIZES

600/50R22.5 159D TL
800/45R26.5 174D TL
710/50R30.5 173D TL
800/45R30.5 176D TL
600/60R30.5 169D TL
850/50R30.5 182D TL

MICHELIN CARGOXBIB

Tire specifications and pressure table (bar & psi). Load per tire in kg*

Ø inches	Description	CAI	e mm	D mm	R' mm	RC mm	Recommended Rim	Acceptable Rim	Tube (Code)	75% internal volume (litres)	Tread depth (mm)
22.5	600/50R22.5 159D TL	048429	616	1181	510	3478	AG20.00 (H2)			298	17
Bar	1 1.3 1.5 1.9 2.2 2.5 2.8 3.1 3.4 3.7 4										
Psi	15 19 22 28 32 36 41 45 49 54 58										
10 km/h	3570 4170 4575 5375 5980 6475 6755 7035 7320 7600 7880										
25 km/h	3020 3570 3940 4670 5225 5675 5920 6170 6415 6665 6910										
40 km/h	2640 3105 3420 4040 4510 4890 5105 5315 5525 5740 5950										
50 km/h	2340 2760 3035 3595 4010 4355 4540 4730 4915 5105 5290										
65 km/h	1950 2290 2520 2970 3315 3595 3750 3910 4065 4225 4380										

Ø inches	Description	CAI	e mm	D mm	R' mm	RC mm	Recommended Rim	Acceptable Rim	Tube (Code)	75% internal volume (litres)	Tread depth (mm)
26.5	800/45R26.5 174D TL	248959	815	1395	595	4097	AG28.00 (H2)	AG24.00 (H2)		561	19
Bar	1 1.3 1.5 1.9 2.2 2.5 2.8 3.1 3.4 3.7 4										
Psi	15 19 22 28 32 36 41 45 49 54 58										
10 km/h	5070 5910 6475 7595 8440 9190 9765 10340 10915 11485 12060										
25 km/h	4230 5015 5535 6585 7365 8060 8565 9070 9580 10085 10590										
40 km/h	3640 4315 4765 5665 6340 6935 7370 7805 8240 8675 9110										
50 km/h	3240 3840 4240 5040 5640 6170 6560 6945 7335 7720 8110										
65 km/h	2680 3175 3505 4165 4660 5095 5420 5740 6060 6380 6700										

Ø inches	Description	CAI	e mm	D mm	R' mm	RC mm	Recommended Rim	Acceptable Rim	Tube (Code)	75% internal volume (litres)	Tread depth (mm)
30.5	710/50R30.5 173D TL	002786	728	1495	649	4408	AG24.00 (H2)			537	21
Bar	1 1.3 1.5 1.9 2.2 2.5 2.8 3.1 3.4 3.7 4										
Psi	15 19 22 28 32 36 41 45 49 54 58										
10 km/h	5310 6205 6800 7990 8885 9620 10035 10450 10870 11285 11700										
25 km/h	4490 5310 5855 6945 7765 8435 8800 9170 9535 9905 10270										
40 km/h	3910 4605 5070 6000 6695 7265 7580 7895 8210 8525 8840										
50 km/h	3470 4090 4505 5335 5955 6465 6745 7025 7310 7590 7870										
65 km/h	2900 3410 3745 4425 4930 5345 5580 5810 6040 6270 6500										

* Refer to the notes at the end of the tables of this range

MICHELIN CARGOXBIB

Tire specifications and pressure table (bar & psi). Load per tire in kg*

Ø inches	Description	CAI	e mm	D mm	R' mm	RC mm	Recommended Rim	Acceptable Rim	Tube (Code)	75% internal volume (litres)	Tread depth (mm)
30.5	800/45R30.5 176D TL	932951	820	1495	650	4408	AG28.00 (H2)			616	21
Bar	1 1.3 1.5 1.9 2.2 2.5 2.8 3.1 3.4 3.7 4										
Psi	15 19 22 28 32 36 41 45 49 54 58										
10 km/h	5370 6265 6860 8050 8945 9745 10350 10960 11565 12175 12780										
25 km/h	4490 5320 5870 6980 7805 8540 9075 9610 10150 10685 11220										
40 km/h	3860 4575 5055 6005 6725 7355 7815 8275 8740 9200 9660										
50 km/h	3440 4075 4495 5345 5975 6535 6950 7360 7770 8180 8590										
65 km/h	2840 3365 3715 4415 4940 5405 5745 6080 6420 6760 7100										

Ø inches	Description	CAI	e mm	D mm	R' mm	RC mm	Recommended Rim	Acceptable Rim	Tube (Code)	75% internal volume (litres)	Tread depth (mm)
30.5	600/60R30.5 169D TL	236518	639	1496	654	4417	AG20.00 (H2)			469	21
Bar	1 1.3 1.5 1.9 2.2 2.5 2.8 3.1 3.4 3.7 4										
Psi	15 19 22 28 32 36 41 45 49 54 58										
10 km/h	4730 5530 6060 7130 7925 8585 8955 9325 9700 10070 10440										
25 km/h	4000 4735 5220 6200 6930 7530 7855 8180 8510 8835 9160										
40 km/h	3490 4110 4525 5355 5975 6485 6765 7045 7330 7610 7890										
50 km/h	3100 3655 4020 4760 5310 5765 6015 6265 6520 6770 7020										
65 km/h	2590 3040 3345 3945 4400 4770 4975 5180 5390 5595 5800										

Ø inches	Description	CAI	e mm	D mm	R' mm	RC mm	Recommended Rim	Acceptable Rim	Tube (Code)	75% internal volume (litres)	Tread depth (mm)
30.5	850/50R30.5 182D TL	938016	861	1628	692	4778	AG28.00 (H2)			817	23
Bar	1 1.3 1.5 1.9 2.2 2.5 2.8 3.1 3.4 3.7 4										
Psi	15 19 22 28 32 36 41 45 49 54 58										
10 km/h	6430 7500 8210 9640 10705 11665 12390 13120 13845 14575 15300										
25 km/h	5370 6365 7025 8355 9345 10225 10865 11505 12150 12790 13430										
40 km/h	4620 5475 6050 7190 8050 8805 9355 9905 10460 11010 11560										
50 km/h	4110 4875 5380 6400 7160 7835 8325 8815 9310 9800 10290										
65 km/h	3400 4030 4450 5290 5920 6475 6880 7285 7690 8095 8500										

***IMPORTANT:**

The inflation pressure must always be appropriate for the load per tire, the speed of travel and the work to be done. Our recommendations above are provided subject to changes made after the date of publication of these tables (July 2020). Technical data is subject to change without prior notice.

- Add 0.4 bar for use on slopes of more than 20%
- Add 0.4 bar for intense road use exceeding 50% of time on road



MICHELIN XP 27

**ENHANCED ENDURANCE
FOR HEAVY LOADS
AT LOW PRESSURES**



PRODUCTIVITY



PROFITABILITY

SIZES

270/65R16 IMP 134A8/122A8 TL

270/65R18 IMP 136A8/124A8 TL

340/65R18 149A8/137A8 TL

MICHELIN XP 27

Tire specifications and pressure table (bar & psi). Load per tire in kg*

Ø inches	Description		CAI	e mm	D mm	R' mm	RC mm	Recommended Rim		Acceptable Rim		Tube (Code)	75% internal volume (litres)		Tread depth (mm)
16	270/65R16 IMP 134A8/122A8 TL		184332	265	755	333	2300	W8		W9 W7		827	45		9
Bar	1	1.3	1.5	1.9	2.2	2.5	2.8	3.1	3.4	3.7	4	4.1	4.4	4.7	5
Psi	15	19	22	28	32	36	41	45	49	54	58	59	64	68	73
10 km/h	1060	1235	1350	1580	1755	1930	2105	2280	2450	2625	2800	2815	2870	2920	2970
25 km/h	895	1045	1145	1340	1490	1640	1785	1935	2085	2230	2380	2395	2440	2480	2525
30 km/h	840	980	1070	1255	1395	1535	1675	1815	1950	2090	2230	2245	2285	2330	2370
40 km/h	750	875	960	1125	1250	1375	1500	1625	1750	1875	2000	2010	2050	2085	2120
50 km/h	690	805	880	1035	1150	1265	1380	1495	1610	1725	1840	1850	1885	1915	1950

Ø inches	Description		CAI	e mm	D mm	R' mm	RC mm	Recommended Rim		Acceptable Rim		Tube (Code)	75% internal volume (litres)		Tread depth (mm)
18	270/65R18 IMP 136A8/124A8 TL		133069	265	810	361	2472	W8		9 W9		438	51		9
Bar	1	1.3	1.5	1.9	2.2	2.5	2.8	3.1	3.4	3.7	4	4.1	4.4	4.7	5
Psi	15	19	22	28	32	36	41	45	49	54	58	59	64	68	73
10 km/h	1120	1305	1425	1670	1855	2040	2225	2410	2590	2775	2960	2980	3030	3085	3140
25 km/h	950	1105	1210	1420	1575	1730	1885	2040	2200	2355	2510	2525	2570	2620	2665
30 km/h	890	1035	1135	1330	1480	1625	1770	1920	2065	2215	2360	2375	2420	2465	2510
40 km/h	800	930	1020	1195	1325	1455	1585	1715	1850	1980	2110	2125	2160	2200	2240
50 km/h	730	850	930	1095	1215	1335	1455	1575	1700	1820	1940	1950	1990	2025	2060

Ø inches	Description		CAI	e mm	D mm	R' mm	RC mm	Recommended Rim		Acceptable Rim		Tube (Code)	75% internal volume (litres)		Tread depth (mm)
18	340/65R18 149A8/137A8 TL		415969	343	891	393	2720	11		9 W9		828	80		8
Bar	1	1.3	1.5	1.9	2.2	2.5	2.8	3.1	3.4	3.7	4	4.1	4.4	4.7	5
Psi	15	19	22	28	32	36	41	45	49	54	58	59	64	68	73
10 km/h	1620	1885	2065	2420	2685	2950	3215	3480	3750	4015	4280	4305	4390	4470	4550
25 km/h	1380	1605	1755	2060	2285	2510	2735	2960	3190	3415	3640	3665	3730	3800	3870
30 km/h	1290	1505	1645	1930	2145	2360	2575	2790	3000	3215	3430	3450	3515	3575	3640
40 km/h	1160	1350	1475	1730	1920	2110	2300	2490	2680	2870	3060	3080	3135	3195	3250
50 km/h	1160	1350	1475	1730	1920	2110	2300	2490	2680	2870	3060	3080	3135	3195	3250

***IMPORTANT:**

The inflation pressure must always be appropriate for the load per tire, the speed of travel and the work to be done. Our recommendations above are provided subject to changes made after the date of publication of these tables (July 2020). Technical data is subject to change without prior notice.

- Add 0.4 bar for use on slopes of more than 20%
- Add 0.4 bar for intense road use exceeding 50% of time on road

XP27: the 1st load index refers to use on a free wheel (use on hauled equipment), the 2nd refers to use on a drive wheel.

The load/pressure/speed tables correspond to use on a free wheel. For a drive wheel, a 30% load reduction applies per pressure point.



MICHELIN XS

**THE ALL-TERRAIN,
ALL POSITION RADIAL TIRE
FOR CONSTRUCTION,
INDUSTRY AND PUBLIC
WORKS**



ENDURANCE

- Casing made of steel for increased resistance to impacts with high load capacity
- Damage resistant tread pattern using Earthmover technology



MOBILITY

- Wide and flat tread for maximum flotation
- Made for long distance transport up to 80 km/h

SAFETY

- Flexible casing and tread pattern for being driven at low pressures



100% STEEL CONSTRUCTION

- Great stability
- Excellent puncture resistance and better load distribution.

SIZES

525/65R20.5 173F TL

24R20.5 176F TL

MICHELIN XS

Tire specifications and pressure table (bar & psi). Load per tire in kg*

Ø inches	Description	CAI	e mm	D mm	R' mm	RC mm	Recommended Rim	Acceptable Rim	Tube (Code)	75% internal volume (litres)	Tread depth (mm)		
20.5	525/65R20.5 173F TL	109421	521	1200	549	3640	16.00		19	253	17		
Bar	1.5	1.8	2	2.2	2.4	2.6	2.8	3	3.2	3.4	3.6	3.8	4
Psi	22	26	29	32	35	38	41	44	46	49	52	55	58
30 km/h	2430	2860	3145	3430	3715	4050	4435	4815	4970	5130	5285	5445	5600
40 km/h	2370	2770	3035	3300	3565	3875	4230	4580	4750	4920	5090	5260	5430
50 km/h	2315	2680	2925	3165	3410	3695	4020	4350	4530	4715	4895	5080	5260
65 km/h				3000	3195	3390	3585	3780	3970	4165	4360	4555	4750
80 km/h					2325	2470	2620	2765	2915	3060	3205	3355	3500

Ø inches	Description	CAI	e mm	D mm	R' mm	RC mm	Recommended Rim	Acceptable Rim	Tube (Code)	75% internal volume (litres)	Tread depth (mm)		
20.5	24R20.5 176F TL	109174	602	1374	584	4148	18.00			404	17		
Bar	1.5	1.8	2	2.2	2.4	2.6	2.8	3	3.2	3.4	3.6	3.8	4
Psi	22	26	29	32	35	38	41	44	46	49	52	55	58
30 km/h	3800	4400	4800	5200	5600	6100	6705	7310	7550	7785	8025	8260	8500
40 km/h	3650	4230	4615	5000	5385	5860	6415	6970	7215	7460	7705	7950	8195
50 km/h	3505	4060	4435	4805	5175	5615	6120	6625	6880	7130	7385	7635	7890
65 km/h				4350	4645	4940	5235	5530	5820	6115	6410	6705	7000
80 km/h					3325	3535	3745	3955	4165	4370	4580	4790	5000

***IMPORTANT:**

The inflation pressure must always be appropriate for the load per tire, the speed of travel and the work to be done. Our recommendations above are provided subject to changes made after the date of publication of these tables (July 2020). Technical data is subject to change without prior notice.

- Add 0.4 bar for use on slopes of more than 20%
- Add 0.4 bar for intense road use exceeding 50% of time on road

CONTENTS

SELECT A TIRE, USE AND OPERATION	3
TIRE MARKINGS	4
LOAD INDICES AND SPEED RATINGS	5
OPERATING INSTRUCTIONS	6
CALCULATION OF MECHANICAL LEAD	7
FRONT WHEEL LEAD % MEASUREMENT	8
LOAD-BALANCING CALCULATION	9
RIM AND O-RING REFERENCES	11
INNER TUBE AND VALVE REFERENCES	12
VALVE CHARACTERISTICS	16
INSTRUCTIONS FOR REMOVING / FITTING TIRES	18

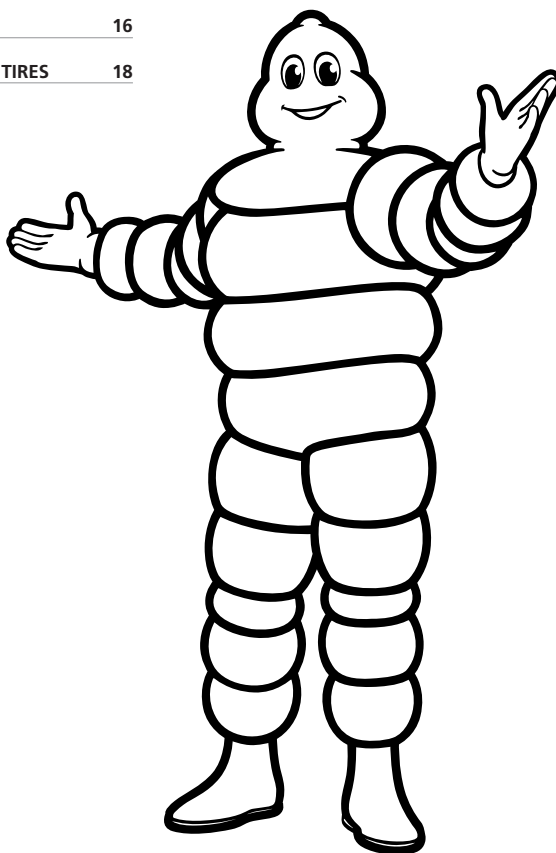

SELECT A TIRE, USE AND OPERATION

Tire selection must comply with regulations and the equipment recommended by the manufacturers of the vehicle and equipment, or an official organisation (size, load index and speed rating, structure - radial/bias, etc.).

Consideration must be given to the conditions under which the tire is to be used so that its performance meets users' requirements.

When changing a vehicle's original equipment, make sure the planned solution meets current regulations, check the vehicle's constraints and the manufacturer's recommendations (refer to local legislation).

In some countries, a vehicle modified in this way must receive authorisation from the relevant authorities.

MICHELIN tires are designed for a specific use. Any other use constitutes abnormal use.

However in some cases, Michelin can authorise a waiver which will specify the accepted usage limits and conditions under the waiver.

Michelin will not be held liable for abnormal use of its tires or use in the absence of any express, written waiver.

Prior to being fitted, all used or worn tires or tires involved in an accident must be thoroughly inspected by a professional to guarantee user safety and compliance with current regulations.

Incorrect use or choice of tire may also contribute to some mechanical parts experiencing premature wear.

TIRE MARKINGS

WHAT DO THE MARKINGS ON A TIRE MEAN?



XeoBib	Range
VF = Very High Flexion	Prefix designating a standardised category of tires
650	Nominal section width of the tire in mm
60	Aspect ratio (ratio between sidewall height/nominal tire section) as a %
R	Structure: «R» for radial «-» for bias Nominal rim
38	Diameter in inches
155	Standardized load index (see page 13)
D	Standardized speed rating (see page 13)
Radial	Structure
Tubeless	Tire with no inner tube
Michelin® X®	Trademark

TIRE DIMENSIONS

SW	Tire section width
R'	Static Loaded Radius
OD	Overall diameter = 2 R
ø	Rim diameter

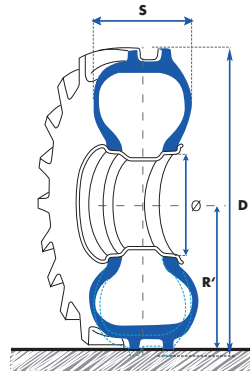

THE 42" SERIES... AND 38" EQUIVALENT

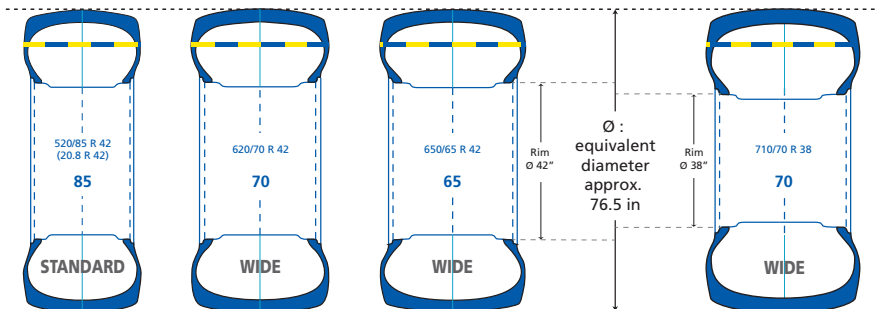

LOAD INDICES AND SPEED RATINGS

All tires come with operational references comprising the load capacity index (number) and speed rating (letter or letter and number).

The tables below show the tire load indexes and speed ratings with corresponding values

LOAD INDEXES

Index	Load in kg	Index	Load in kg	Index	Load in kg	Index	Load in kg	Index	Load in kg	Index	Load in kg
101	825	117	1285	133	2060	149	3250	165	5150	181	8250
102	850	118	1320	134	2120	150	3350	166	5300	182	8500
103	875	119	1360	135	2180	151	3450	167	5450	183	8750
104	900	120	1400	136	2240	152	3550	168	5600	184	9000
105	925	121	1450	137	2300	153	3650	169	5800	185	9250
106	950	122	1500	138	2360	154	3750	170	6000	186	9500
107	975	123	1550	139	2430	155	3875	171	6150	187	9750
108	1000	124	1600	140	2500	156	4000	172	6300	188	10000
109	1030	125	1650	141	2575	157	4125	173	6500	189	10300
110	1060	126	1700	142	2650	158	4250	174	6700	190	10600
111	1090	127	1750	143	2725	159	4375	175	6900	191	10900
112	1120	128	1800	144	2800	160	4500	176	7100	192	11200
113	1150	129	1850	145	2900	161	4625	177	7300	193	11500
114	1180	130	1900	146	3000	162	4750	178	7500	194	11800
115	1215	131	1950	147	3075	163	4875	179	7750	195	12150
116	1250	132	2000	148	3150	164	5000	180	8000	196	12500

SPEED RATINGS

Code	Speed in km/h	Speed in mph
A2	10	6
A5	25	15
A6	30	20
A8	40	25
B	50	30
D	65	40
E	70	44
F	80	50
G	90	55
J	100	60

UNITS OF MEASUREMENT

1 centimetre	cm	= 0.3937 inch	1 inch	in	= 2.54 cm
1 metre	m	= 3.281 feet	1 foot	ft	= 0.3048 m
1 kilometre	km	= 0.6214 mile	1 mile	mi	= 1.6093 km
1 litre	l	= 0.2199754 imp. gallons	1 imp. Gallon	imp. gall.	= 4.545963 litres
1 kilogram	kg	= 2.204622 pounds	1 pound	lb	= 0.4535924 kg
1 horsepower	hp	= 735.499 W	1 kilowatt	kw	= 1.3596216173 hp
1 bar	bar	= 14.5037738 psi	1 bar	bar	= 100 kPa (kilopascal)
1 pound per square inch	psi	= 6.89476 kPa	1 imp. acre		= 0.4046842 ha
1 hectare	ha	= 2.4711 imp. acres	1 square inch (imp.)	sq in	= 6.451578 cm ²
1 square centimetre	cm²	= 0.1550 sq.in (imp.)	1 tonne	t	= 0.9842064 tn (imp)
1 ton (imp)	tn	= 1.016047 t	1 kilometre/hour	km/h	= 0.62137 mph
1 mile per hour	mph	= 1.609344 km/h			

OPERATING INSTRUCTIONS

■ DETERMINING TIRE PRESSURE:

- Tire pressure is always determined in relation to load per tire, speed and work to be carried out.
- The load used is the highest: For tractors:
 - front axle: tractor with its weights / front equipment in the transport position and no rear axle load
 - rear axle: tractor with equipment in the transport position.

Note : for a tractor equipped with a front loader, assume max. load on the loader.

For harvesters: full load (full hopper) with cutting bar (or picker).

Note : for harvesters, determine the axle load:

- front axle with fully loaded bin and head attached, use cyclic loading speed schedule and pressure.
 - front axle with folding head, empty bin using road speed schedule and pressure.
 - rear axle without the cutter bar or picker
- Determine the pressure for «field use» and «road use» and select the higher of the two.
 - For intensive road use or on slopes and inclines, follow the instructions given in "Technical specifications of MICHELIN tires".

■ WHEN IN USE

- Spread loads correctly.
- Adapt your driving to the conditions (load, speed, slope, incline, condition of road or other terrain).

■ INFORMATION

- Check tire pressure regularly.
- Periodically check the condition of your tires and have them checked by a trained and qualified professional
Reminder:
 - Damage caused by a puncture or an impact may only become apparent after some time
 - Tires age even when not in use
- Have any repairs carried out by a trained and qualified professional.

CALCULATION OF MECHANICAL LEAD

For the transmission unit of a 4-wheel drive tractor to operate correctly the correct mechanical lead must be used. This rule does not apply in the case of 4 wheels of the same size.

Most tractor manufacturers impose a mechanical lead of between 0% and 6%. This lead is specific, and may vary depending on the manufacturer and the vehicle.

An inappropriate mechanical lead ratio

- increases fuel consumption,
- results in more rapid front and rear tire wear,
- results in more rapid wear on the transmission unit,
- results in poor tractor performance when doing some jobs (e.g. ploughing)

and causes

- abrupt front axle engagement,
- a loss in power and performance,
- deterioration of the top soil.

Note: The front axle must never be engaged on the road!

Calculation of mechanical lead:

$$\frac{(RC_{\text{FRONT}} \times R) - RC_{\text{REAR}}}{RC_{\text{REAR}}} \times 100 = \text{mechanical lead in \%}$$

RC_{Rear} : Rear tire rolling circumference (specified in the technical documentation)

RC_{Front} : Front tire rolling circumference (specified in the technical documentation)

R: inter-axle ratio (This is fixed initially by the manufacturer)

FRONT WHEEL LEAD % MEASUREMENT



Put marks on the tires as picture above.

■ STEP 1 :

FRONT AXLE **NOT ENGAGED (out of 4WD)**

Do 10 turns of rear tires and count the number **N** of turns for front.

■ STEP 2 :

FRONT AXLE **ENGAGED (in 4WD)**

Do 10 turns of rear tires and count the number **N1** of turns for front.

$$\text{Calculation of measurement} = \frac{(N1 - N)}{N} \times 100$$

LOAD-BALANCING CALCULATION

SINGLE FITTING

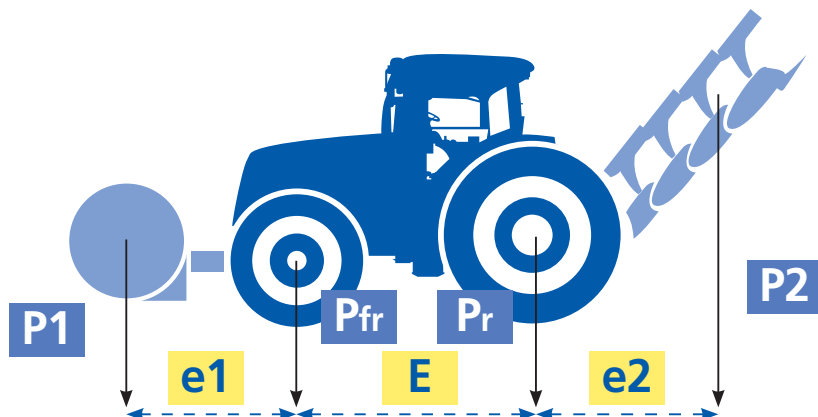

	Front axle (fr)	Rear axle (re)
Tractor (kg)	P fr	P re
Equipment or weights (kg)	P 1	P 2
Calculation for equipment or weights (kg)	$P 1 \times (e1/E)$	$P 2 \times (e2/E)$
Total for axle (kg)	$P fr + P 1 + [P 1 \times (e1/E)]$	$P re + P 2 + [P 2 \times (e2/E)]$
Number of tyres	N fr	N re
Load per tyre (kg)	Total axle fr / N fr	Total axle re / N re



QR code to access pressure calculator app

Examples :

Data	Front	Rear
Tractor (kg)	3 000	5 000
Equipment or weights (kg)	1 000	2 000
Distance (metres)	$E = 3 \text{ m} / e1 = 1,5 \text{ m} / e2 = 2,5 \text{ m}$	

Calculations	Front axle (fr)	Rear axle (re)
Tractor (kg)	3 000	5 000
Equipment or weights (kg)	1 000	2 000
Calculation for equipment or weights (kg)	$1 000 \times (1,5 / 3) = 500$	$2 000 \times (2,5 / 3) = 1 666$
Total for axle (kg)	$3 000 + 1 000 + 500 = 4 500$	$5 000 + 2 000 + 1 666 = 8 666$
Number of tyres	2	2
Load per tyre (kg)	$4 500 / 2 = 2 250$	$8 666 / 2 = 4 333$

LOAD-BALANCING CALCULATION

■ DUAL *OR TRIPLE* FITTING

- 1 - Divide the axle load by 4 if dual (or by 6 if triple)**
- 2 - Then divide the result by 0.88 if dual (or by 0.82 if triple)**

* For load calculation, see previous page.

Example of a calculation for a dual fitting:

- Tractor with 650/85R38 MICHELIN MACHXBIB 173A8/173B TL
- Established axle load = 14000 kg
- Use = stubble plowing

a) If the Dual line at the desired speed is in the load/pressure table:

- divide the total load by 4 (4 tires)
- use the Dual line to determine pressure

b) If the Dual line at the desired speed is not in the load/pressure table:

- divide the total load by 4
- divide the result by 0.88
- use the desired speed line on the load/pressure table

Example for a total load of 14000 kg on a dual fitted rear axle:

$$[30,800 / 4] / 0.88 = 3977 \text{ kg}$$

i.e. recommended pressure of 0.8 bar for a speed of 30 km/h

Note: for triple fitting, divide the load by 6, then divide by 0.82 to obtain the load in question.

RIM AND O-RING REFERENCES

Ensure that the rim is compatible in terms of load and pressure with the use.

Type of rim	Sizes	Dimension F in mm	Dimension H in mm	Dimension P in mm
5° standard hollow rim	2.50 C	63,5	16,5	
	3.00 D	76		
	3.50 D	89	18	
	4.00 E	101,5		
	4.50 E	114,5	20	18
	5.00 E	127		23,5
	5.375 I	136,5	16	23
	5.50 F	140		
	6.00 F	152,5	22,5	23,5
6.50 F	165			
5° conical seat hollow rim	9	228,5		27
	11	279,5		
	12	305	25,5	
	13	330		31,5
	14	355,5		
	16	406,4	25,4	
15° conical seat hollow rim	10.50	266,7		
	11.75	298,5		
	12.25	311		
	13.00	330		
	14.00	355,5		
	15.00	381		
	16.00	406,5	12,7	44
	AG 16.00	406,5		
	17.00	432		
	18.00	457		
	20.00	508		
	AG 20.00	508		
	AG 24.00	609,5		
	AG 28.00	711		
3-PIECE RIM	11	279,5		
	12	305	25,5	
	13	330		
	36.0 TH	914,4	38,1	
	36.00 VA	914,4	43,1	
W rim	W 6	152,4		
	W 7	177,8	22,2	23,8
	W 8	203,2		
	W 8L	203,2		
	W 9	228,6	25,4	
	W 10	254		
	W 10L	254	22,2	27
	W 11	279,4		
	W 12	304,8		
	W 13	330,2		
	W 14L	355,6	25,4	
	W 15L	381		
	W 16L	406,4		33
	W 18L	457,2		

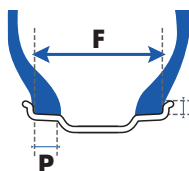

F = interior width
H = Flange height (+/- 1 mm)
P = Seat width

Type of rim	Sizes	Dimension F in mm	Dimension H in mm	Dimension P in mm	
DW rim	DW 10	254			
	DW 11	279,4			
	DW 12	304,8		27	
	DW 13	330,2			
	DW 14L	355,6	25,4	36,5	
	DW 15L	381			
	DW 16L	406,4			
	DW 17L	431,8			
	DW 18L	457,2			
	DW 20B	508			
	DW 21B	533,4			
	DW 23B	584,2	28,6	50,8	
	DW 24B	609,5			
	DW 25B	635			
	DW 27B	686			
	DW 28B	711			
	DW 30B	762			
	TW rim	TW 13	330		27
		TW 14L	355,5	25,5	36,5
TW 15L		381			
TW 16L		406,5			
TW 18L		457			
TW 20B		508	29	50,8	
TW 21B		533,5			
TW 23B		584			
TW 24B		609,5			
TW 25B		635			
DD rim	DD 16L	406,5	41	50,5	
	DD 18L	457			
MW rim	MW 20	508	29	50,8	
	MW 23	584			
	MW 25	635			
DH27B rim	DH 27B	686	29	54	

If the DW rim is authorised then so is the corresponding TW rim (ETRTO)

O-RINGS FOR 3-PIECE RIMS

Reference	Designation	Note	IAC
R 1681	O-ring OR 6.6 - 20	For 20" rim in 3 pieces	553215
R 1438	O-ring OR 2 - 25	For 25" rim in 3 pieces	553201
R 2052	O-ring OR 2 - 32	For 32" rim in 3 pieces	553055

O-ring designations:

- OR: abbreviation of o-ring
- The first number is the section of the ring joint - a whole number expressing 8ths of an inch (e.g.: 2 = 2/8").
- The second number is the diameter of the seat - a whole number expressed in inches.

INNER TUBE AND VALVE REFERENCES

TIRE & RIM DESCRIPTION		VALVE		KLEBER TUBE		MICHELIN TUBE		PACKAGING
RIM Ø (INCHES)	TIRE SIZE	VALVE REF.	VALVE OFFSET	KLEBER REF.	KLEBER CAI	MICHELIN REF.	MICHELIN CAI	
6	3.50 - 4.00	10SC29	0	826	158611			8
8	4.00	10SCH40	0	360	125528			8
12	4.00	TR13	13			12C13	125674	40
	7.00	TR15	25	389	101397			4
15	4.00	TR13	15			15CB13	125682	40
	5.00 - 6.70	TR13	22			15F13	125622	24
15.3	10.0/75 - 11.5/80 - 12.5/80	TR15	80	463	170029			4
16	4.50	TR218A	19	420	101467	M420	834861	4
	5.50 - 6.00	TR15	60	182	170010	M182	884753	4
	6.00 - 6.50	TR218A	60	313	039318	M313	183634	1
	6.50 - 7.00	TR15	65	311	170014			4
	7.50	TR218A	70	431	170000	M431	509471	1
	7.50	TR13	25			16J13	125639	16
	7.50	TR15	70	317	170016	16J15	125669	16
	10.00 - 11.00	TR218A	90	485	170030	M485	410859	1
	11LR - 280/70	TR218A	65	184	171108	M184	764859	1
10.50 - 270/65 - 275/65 - 320/65	TR218A	65	827	813635	M827	030552	1	
16.5	260/70 - 300/70	TR218A	65	184	171108	M184	764859	1
18	7.50	TR218A	70	440	170001	M440	594387	1
	7.50	TR15	70	441	170023			4
	10.5/80 - 280/80 - 260/70 - 280/70 - 270/65	TR218A	70	438	171109	M438	582674	1
	12.0 - 12.5 - 335/80 - 340/80 - 320/65 - 340/65	TR218A	90	444	170025	M444	756917	1
	12.0 - 12.5 - 335/80 - 340/80 - 13.0/65 - 320/65 - 335/65 - 340/65	TR15	80	828	057866	M828	126008	1
19	4.00 - 4.50	TR13	15	446	101417			4
	6.00	TR13	50	449	320346			1
	6.00	TR15	50	452	170026			1
19.5	445/70 (18 R 19.5)	DR1964				19.5/20.5 UD	101280	3

INNER TUBE AND VALVE REFERENCES

TIRE & RIM DESCRIPTION		VALVE		KLEBER TUBE		MICHELIN TUBE		PACKAGING
RIM Ø (INCHES)	TIRE SIZE	VALVE REF.	VALVE OFFSET	KLEBER REF.	KLEBER CAI	MICHELIN REF.	MICHELIN CAI	
20	7.50	TR218A	65	655	170004	M655	575125	1
	7.50	TR15	60	660	170033			4
	9.5 - 260/70 - 280/70	TR218A	65	533	171110	M533	504653	1
	10.00 (Flap)					20x7.50 E	320222	5
	10.00 (Tube)	582				20N	101162	7
	10.5 - 11.2 - 280/80 - 300/70 - 320/70	TR218A	90	542	171111			1
	12.4 - 320/85 - 12.5/80 - 335/80 - 340/80 - 340/75	TR218A	90	444	170025	M444	756917	1
	12.5 - 14.5 - 14.9 - 335/80 - 340/80 - 340/75 - 375/75 - 380/75 - 420/75 - 425/75 - 360/70 - 400/70 - 405/70 - 420/65 - 440/65	TR218A	90	664	171112	M664	657648	1
	For 375/75 and 405/70 R 20 on flat rim	750				20RD	101394	5
	For 425/75 R 20 on flat rim	576				20V	511937	1
For 20" rims in 3 pieces	O-Ring 1681				OR 6.6 - 20	553215	20	
20.5	20.5 - 525/65	DR1964	75			19.5/20.5 UD	101280	3
	24	SC1837	100			20.5W AMD	101331	1
22.5	600/55	TR218A	90	716	170047	M716	346313	1
24	8.3 - 9.5 - 250/85	TR218A	70	686	170035	M686	820931	1
	11.2 - 12.4 - 280/85 - 320/85 - 320/70 - 360/70	TR218A	85	692	170037	M692	970338	1
	13.6 - 14.5 - 340/85 - 380/70 - 420/65	TR218A	85	700	170039	M700	519392	1
	14.9 - 380/85 - 400/80 - 400/70 - 420/70 - 440/65	TR218A	127	703	171114	M703	027015	1
	16.9 - 17.5LR - 19.5LR - 420/85 - 440/80 - 440/70 - 445/70 - 460/70 - 480/70 - 495/70 - 500/70 - 540/70 - 480/65 - 540/65	TR218A	100	710	170042	M710	460503	1
25	1000/50 - For 25" rims in 3 pieces	O-Ring R 1438				OR 2-25 HEUPO	553201	20
26	18.4 - 480/80 - VF520/80 - 480/70 - 520/70 - 580/70 - VF620/70	TR218A	90	716	170047	M716	346313	1
	23.1 - 620/75 - 580/70 - 620/70	TR218A	110	830	823746	M830	036738	1
	620/70	TR218A	110	717	101447	M717	438361	1
	750/65	TR218A	160	833	975074			1
26.5	600/55	TR218A	90	716	170047	M716	346313	1

INNER TUBE AND VALVE REFERENCES

TIRE & RIM DESCRIPTION		VALVE		KLEBER TUBE		MICHELIN TUBE		PACKAGING
RIM Ø (INCHES)	TIRE SIZE	VALVE REF.	VALVE OFFSET	KLEBER REF.	KLEBER CAI	MICHELIN REF.	MICHELIN CAI	
28	9.5 - 11.2 - 280/85	TR218A	65	725	170050	M725	330841	1
	12.4 - 320/85 - 360/70	TR218A	85	726	170051	M726	316215	1
	13.6 - 340/85 - 380/70 - 420/65	TR218A	85	732	170053	M732	049533	1
	14.9 - 380/85 - 420/70 - 440/65 - VF480/60	TR218A	85	821	170148	M821	483956	1
	16.9 - 19.5LR - 420/85 - 440/80 - 480/70 - 480/65 - 540/65 - VF520/60 - VF600/60	TR218A	120	822	170149	M822	428511	1
	600/70 - 600/65	TR218A	110	717	101447	M717	438361	1
30	14.9 - 380/85 - 420/70	TR218A	90	734	170054	M734	626564	1
	16.9 - 420/90 - 420/85 - 420/80 - 480/70 - 540/65 - VF540/65	TR218A	95	754	170058	M754	743325	1
	18.4 - 460/85 - 520/70 - VF600/60	TR218A	95	757	170060	M757	579464	1
	23.1 - 520/85 - 620/75 - IF620/75 - VF620/75 - 600/70 - IF600/70 - VF620/70	TR218A	92	737	192251	M737	589735	1
32	8.3 - 9.5 - 210/95 - 230/95	TR218A	70	758	013109			1
	11.2 - 270/95	TR218A	70	763	983325			1
	12.4 - 320/85	TR218A	90	760	877890			1
	24.5 - 30.5 - 680/85 - IF680/85 - 650/75 - 680/75 - 800/70 - IF800/70 - 800/65 - IF800/65 - 900/60 - IF900/60	TR218A	170	831	664520	M831	289134	1
	1000/55 For 32" rims in 3 pieces	O-Ring R 2052					OR 2-32	553055
34	16.9 - 380/85 - VF380/85 - 420/85 - VF420/85 - 480/70 - IF480/70 - 540/65	TR218A	95	704	171115	M704	862196	1
	18.4 - 460/85 - 500/70 - 520/70 - 540/70 - 600/65 - IF650/65 - VF600/60 - IF650/60	TR218A	100	823	170150	M823	164970	1
	24.5 - 710/75	TR218A	180	765	101429			1
36	9.5 - 11.2 - 12.4 - 230/95 - 270/95 - 320/85	TR218A	65	779	170072	M779	404542	1
	13.6 - 340/85	TR218A	80	780	170073			1



INNER TUBE AND VALVE REFERENCES

TIRE & RIM DESCRIPTION		VALVE		KLEBER TUBE		MICHELIN TUBE		PACKAGING
RIM Ø (INCHES)	TIRE SIZE	VALVE REF.	VALVE OFFSET	KLEBER REF.	KLEBER CAI	MICHELIN REF.	MICHELIN CAI	
38	11.2 - 12.4 - 270/95 - 320/85	TR218A	65	779	170072	M779	404542	1
	13.6 - 380/95 - VF380/95 - 340/85 - 380/80 - VF380/80	TR218A	90	795	170079	M795	456392	1
	14.9 - 16.9 - 380/85 - 420/85 - 480/70	TR218A	95	786	170076	M786	325321	1
	15.5 - 380/95 - VF380/95 - 380/80 - VF380/80 - 400/75	TR218A	90	796	118826	M796	044169	1
	18.4 - 460/85 - 520/70 - 540/65 - VF600/60	TR218A	100	824	170151	M824	156066	1
	20.8 - 520/85 - 580/70 - 620/70 - 600/65 - 650/65 - IF650/65 - VF650/60 - IF710/60 - VF710/60	TR218A	105	825	170152	M825	701676	1
	650/85 - IF650/85 - IF710/85 - 650/75 - IF650/75 - IF680/75 - 710/70 - IF800/70	TR218A	105	804	170088	M804	004503	1
42	16.9 - 18.4 - 480/80	TR218A	90	801	170084	M801	333630	1
	20.8 - 520/85 - VF520/85 - 580/85 - VF650/85 - IF710/75 - 620/70 - 710/70 - IF710/70 - 650/65 - VF650/65 - VF710/60	TR218A	140	802	170006	M802	158373	1
44	11.2 - 270/95	TR218A	80	813	440524			1
46	12.4 - 14.9 - 300/95 - 420/85 - 380/80 - VF380/80 - 420/80	TR218A	80	835	203376	M835	847882	1
	18.4 - 20.8 - 520/85 - 480/80 - VF480/80	TR218A	100	834	467962	M834	072291	1
48	9.5 - 11.2 - 230/95 - 270/95	TR218A	80	835	203376	M835	847882	1
50	320/90	TR218A	70	816	170007	M816	762800	1
52	12.4 - 300/95	TR218A	70	816	170007	M816	762800	1
54	11.2 - 270/95 - 320/90	TR218A	70	816	170007	M816	762800	1

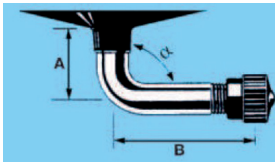
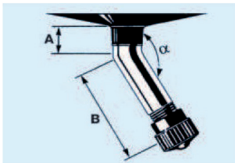
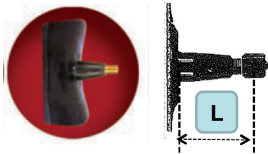
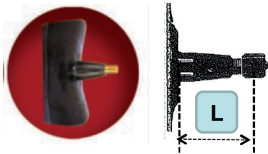
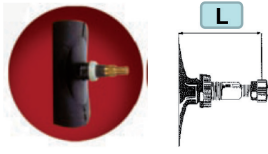
VALVE CHARACTERISTICS

Sizes	Type of rim	Dimension F in mm
INNER TUBE VALVES		
10 SC29		A = 15 mm B = 29 mm $\alpha = 90^\circ$ $\varnothing = \text{valve hole} = 10 \text{ mm}$
10 SCH40		A = 13 mm B = 27 mm $\alpha = 150^\circ$ $\varnothing = \text{valve hole} = 10,2 \text{ mm}$
TR13 (ETRTO = V2-01-1)		L = 35 mm $\varnothing = \text{valve hole} = 11,5 \text{ mm}$
TR15 (ETRTO = V2-01-2)		L = 35 mm $\varnothing = \text{valve hole} = 16 \text{ mm}$
TR218A (ETRTO = V7-01-1) Air/water valve		L = 47,5 mm $\varnothing = \text{valve hole} = 15,7 \text{ mm}$

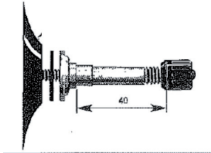
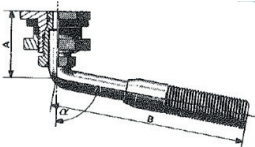
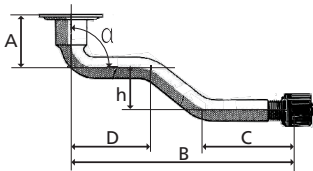
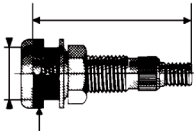
VALVE CHARACTERISTICS

Sizes	Type of rim	Dimension F in mm
INNER TUBE VALVES		
1964		L = 40 mm Ø = valve hole = 9,7 mm
1837 Equivalence : • TRA = TRJ650 • ETRTO = V5-04-1		A = 27 mm B = 79 mm $\alpha = 80^\circ$ Ø = valve hole = 20,5 mm
582 (ETRTO = V3.06.5)		A = 20,5 mm / B = 131 mm C = 49 mm / D = 62,5 mm $\alpha = 90^\circ$ / h = 17 mm
1123 (ETRTO = V3.06.8)		A = 24,5 mm / B = 126,5 mm C = 50,5 mm / D = 61,5 mm $\alpha = 94^\circ$ / h = 17 mm
TUBELESS VALVES		
TR618A (ETRO = V5-01-1) Air/water valve		L = 47,5 mm Ø = valve hole = 15,7 mm
AIR / WATER VALVE TIP		
		

INSTRUCTIONS FOR REMOVING / FITTING TIRES

There are risks in removing and fitting tires, so procedures must be carried out by trained and qualified staff, using appropriate tools and methods.

Never give this task to an unaccompanied apprentice; if several people are involved in the task with Large tires, ensure **at least one of the team** remains the same **for all parts of the procedure**.

The compressed air supply must be equipped with a pressure limit switch.

Failure to follow these instructions can lead to incorrect fitting of the tire on the rim, resulting in tire blow-outs and potentially serious or fatal injuries.

REMOVING A TIRE FROM THE RIM

1. Never try to unseal the rim and/or beads on an inflated tire.
2. The internal mechanism of the valve must be remove.
 - make sure that the tire is fully deflated before removing it,
 - do not use tools that may damage the sidewalls or the tire beads,
 - unseat the beads using the removal slots (if present),
 - to facilitate removal and protect the beads, particularly in case of a puncture, lubricate the rim seats and tire beads,
 - if the rim shows obvious signs of damage then the tire must be deflated before dismantling the assembly.

PREPARATION FOR FITTING

Ensure that the rim is compatible in terms of load and pressure with the use.

1. Before fitting, ensure that the rim, tire and inner tube are compatible, and check that:
 - the tire is compatible with the vehicle or machine
 - the diameter of the rim seat corresponds to the seat of the tire to be fitted (e.g.: 18.4 R 30 tire Rim: DW16L x 30),
 - the tire may be fitted to this rim (see characteristics in the Manufacturer's Documentation).

 Never fit 15" tires to rims with 15.3" seats.
Never fit 16" tires to rims with 16.1" or 16.5" seats.

2. Before fitting a tire to a rim that has already been used:
 - ensure the rim is clean and in perfect condition (showing no damage),
 - if not, then thoroughly clean the rim using a wire brush.

 Never fit a tire to a rim with cracks, significant distortion, signs of fracture, evidence of welded repairs, etc.

INSTRUCTIONS FOR REMOVING / FITTING TIRES

3. If the tyre has been used, carefully examine its interior and exterior for possible damage.
 - if it shows signs of damage or deterioration that are deemed irreparable by a specialist, discard the tyre.
4. For inner tube fittings, always use a new inner tube suitable for the tyre dimensions (inner tube markings showing compatible tyre sizes).

⚠ Do not fit the inner tube to a damaged or repaired rim, or to a rim with a finish incompatible with a tube.

Fit a new Tubeless valve whenever you replace a Tubeless tyre.

5. Always use tools that have no sharp edges, are in good condition and are suitable for the tyres and rims (bead unseating, levers, machines...).

For wide or large tyres, we recommend using a bead pusher or bead unseating tool (with appropriate mechanical assistance) to fit the second bead.

Before fitting, lubricate the rim seats and tyre beads. Apply a thin layer of lubricant to the surfaces shown on the diagram below; on the outside of the beads the lubricant should reach 5 cm above the rim flange.

Only use products designed for this purpose that will not degrade the tyre (do not for example use hydrocarbon, silicon or antifreeze-based products).

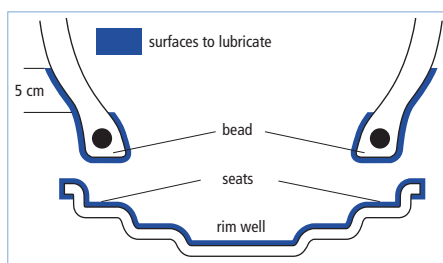

INSTRUCTIONS FOR REMOVING / FITTING TIRES

■ VERTICAL FITTING OF TIRE TO WHEEL

1. Position the valve or valve hole at the bottom.
2. If there is a diagram of the valve on the sidewall of the tire, position the diagram as close as possible to the rim valve hole or valve.
3. Slip the tire onto the rim so that the first tire bead is positioned against the rim flange. Remember to rotate in the direction indicated by the arrow on the tire (if present).
4. Using a suitable lever to apply pressure approximately every 10 cm:
 - push the first bead over the rim flange.

Once the first bead is over:

- position the lightly inflated inner tube inside the tire (for inner tube fittings),
- fix the valve by partially tightening the nut.

For the second bead:

- lever it over the rim flange,
- finishing at the valve.

5. Centring the tire, fitting the beads

- lower the jack slightly to optimise tire centring,
- pull out the valve's inner mechanism,
- slowly and partially inflate for optimal bead positioning,
- check the beads are not pinching the inner tube,
- inflate to 2.5 bar but no more, to ensure that the beads are properly positioned.

■ INFLATION AND BEAD POSITIONING

Apply safety rules:

- system to support the tire assembly (safety cage),
- safety goggles,
- safety footwear,
- ear defenders.

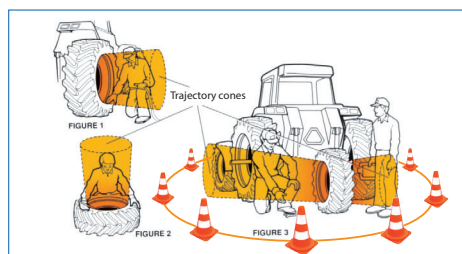

If there is no safety bar or cage, the operator should be as far as possible from the tire and the rim.

⚠ Never stand within the trajectory cones (Figures 1, 2 and 3), to avoid any risk of physical injury in the event of an incident.

For optimum safety conditions use a fully functional inflation gun connected to the valve by an air-hose extension of at least 3 meters, with a clip fitting to the valve and a calibrated pressure-gauge (never lock the trigger).

When positioning the beads take particular care to ensure they are correctly located and centred in relation to the rim flanges and inflate to 2.5 bar, but no more.

INSTRUCTIONS FOR REMOVING / FITTING TIRES

If the beads are not correctly positioned:

- deflate, re-lubricate and inflate to 2.5 bars
- repeat the operation as often as necessary until the beads are correctly positioned.

To fit and position the beads to the rim seats
INFLATE TO 2.5 BARS WITHOUT EXCEEDING THIS PRESSURE

The pictogram opposite shows the maximum inflation pressure which must not be exceeded when positioning the beads.

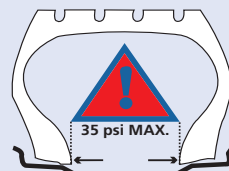

Once all the preceding operations have been properly executed,

- replace the valve's inner mechanism,
- tighten the nut on the valve by hand,
- inflate to the determined service pressure, according to the load levels stated in the manufacturer's documentation, or to storage pressure,
- tighten the valve cap after any inflation or pressure check, as this alone ensures that the valve remains clean and sealed.

If fitting the tire horizontally on the ground (not recommended because it is impossible to see if the lower bead is in place), take the following additional precautions:

- Initially, do not go above a maximum pressure of 0.7 bar (to establish the seal),
- Lift the tire-rim assembly, place it in a safety cage or position the upper part against a wall, never against a door or light partition wall,
- Follow the instructions for inflation and positioning the beads.

Note:

All radial tires to be used at low pressures must be fitted to high quality rims.

■ BEGINNING OPERATIONS / RECOMMENDATIONS

- When transporting machinery (by road, rail or ship), we recommend inflating tires to 1.8 bar (26 psi) to avoid damage due to certain stowage systems.
- When starting the machinery, pressures must be determined and adjusted according to the load on the tires and actual conditions of use.

USER INSTRUCTIONS

Correct pressure

- =
- ✓ Comfort
 - ✓ Grip
 - ✓ Soil protection
 - ✓ Type service life
 - ✓ Optimal machine productivity

INSTRUCTIONS FOR REMOVING / FITTING TIRES

■ BALLASTING

• Ballasting tires with liquids

In specific cases, to increase adhesion weight or lower the machine's centre of gravity, both Tubeless and Tube Type tires can be ballasted with liquid.

Agricultural valves are "air and water". This means tires can be filled with liquid (water + anti-freeze) to a 75% maximum (diagram 1).

In winter, temperatures may fall below freezing and at 0°C the use of a Glycol based anti-freeze product is required. *As MICHELIN is not involved in the design of those products, MICHELIN's warranty specifically states that MICHELIN will not be held responsible for any associated damages to the tires.*

Fill the inner tube or Tubeless tire with liquid up to the level of the valve (valve at highest point), while releasing the air (diagram 2).

Inflation and pressure are adjusted using air.

As the volume of air providing pressure is low (around 25% volume), regular pressure checks are essential - we recommend monthly.

• Tubeless liquid ballasting

- Assemble and position the tire; see "Inflation and bead positioning",
- Deflate the tire to a low pressure (roughly 0.5 bar)
- Position the valve at the highest point,
- Start to fill the tire with liquid (water + anti-freeze), to a maximum of 75% while releasing the air (diagram 2),
- Finish inflating with air and adjust the pressure.

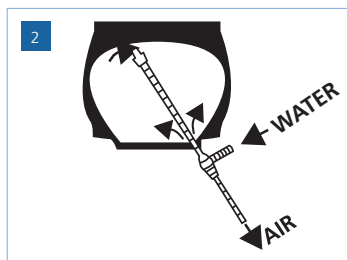
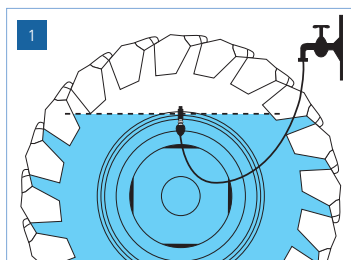

INSTRUCTIONS FOR REMOVING / FITTING TIRES

■ STORAGE

To be correctly stored, tires must be kept in clean conditions in dry and ventilated premises, away from direct sunlight. They must be kept away from:

- any source of ozone (electric motor, transformer, arc welding station etc...).
- any chemicals, solvents and hydrocarbons that may affect the nature of the rubber.
- any objects that could pierce the rubber (sharp or pointed metal objects etc.).

Keep away from flames or hot objects.

During storage periods, agricultural tires and inner tubes must be stored to avoid damage due to tension or compression, and so assembled and inflated if stacked; de-ballast vehicle-mounted tires as much as possible and over-inflate by 0.5 bar in relation to in-use pressures.

 **Never store bare tires or whole off-vehicle wheels in direct contact with the ground for long periods.**

The use of protective gloves is recommended when handling tires.

 Never heat, weld or solder a rim or wheel with a tire fitted.
Always remove the tire from the rim before any intervention.

 Always use the Michelin inflation table to decide on the correct pressure for the intended use

 Under-inflation causes the carcass to become excessively misshapen and renders the tire unusable.

 Over-inflation reduces the surface area in contact with the ground, causing a loss of grip and making the tire more sensitive to impacts and cuts.

 If loads are lower than those shown in our load pressure tables, never go below the minimum tire pressure shown.



AGRICULTURE TIRES TECHNICAL DATABOOK

2020

HEADQUARTERS

Manufacture Française des Pneumatiques MICHELIN
A partnership limited by shares with a capital of €504,000,004
Place des Carmes-Déchaux, 63040 Clermont-Ferrand Cedex 9, France
Tel.: +33(0)4 73 32 20 00

www.michelin.fr
Clermont Ferrand Trade and Companies Registry Number 855 200 507

JULY 2020

 AGRO.MICHELIN.COM

 [@MICHELINAGRIUK](https://twitter.com/MICHELINAGRIUK)

 [MICHELIN AGRICULTURE](https://www.youtube.com/MICHELIN AGRICULTURE)

